



# MAGELLAN™

MG5000  
MG5050

**SP**  
S P E C T R A®

SP65  
SP4000  
SP5500  
SP6000  
SP7000

**STAY D™**

Always Armed,  
Never Disarmed

## User Guide



P ▲ R ▲ D O X™

## Warranty

For complete warranty information on this product please refer to the Limited Warranty Statement found on the website [www.paradox.com/terms](http://www.paradox.com/terms). Your use of the Paradox product signifies your acceptance of all warranty terms and conditions.

## Limitations of Alarm Systems

We strongly advise that you review and take into consideration the "Limitations of Alarm Systems" document available on our website at <http://paradox.com/Terms/>.

## Warning for Connections to Non-Traditional Telephony (e.g. VoIP)

Paradox alarm equipment was designed to work effectively around traditional telephone systems. For those customers who are using a Paradox alarm panel connected to a non-traditional telephone system, such as "Voice Over Internet Protocol" (VoIP) that converts the voice signal from your telephone to a digital signal traveling over the Internet, you should be aware that your alarm system may not function as effectively as with traditional telephone systems.

For example, if your VoIP equipment has no battery back-up, during a power failure your system's ability to transmit signals to the central station may be compromised. Or, if your VoIP connection becomes disabled, your telephone line monitoring feature may also be compromised. Other concerns would include, without limitation, Internet connection failures which may be more frequent than regular telephone line outages.

We therefore strongly recommend that you discuss these and other limitations involved with operating an alarm system on a VoIP or other non-traditional telephone system with your installation company. They should be able to offer or recommend measures to reduce the risks involved and give you a better understanding.

## WARNINGS: Information to User

This equipment has been tested and found to comply with the limits for Class B digital devices, pursuant to Part 15 of FCC rules. These limits are designed to provide reasonable protection against harmful interference in a residential installation. This equipment generates, uses and can radiate radio frequency energy, and, if not installed and used in accordance with the instructions, may cause harmful interference to radio communications. However, there is no guarantee that interference will not occur in a particular installation. If this equipment does cause harmful interference to equipment intermittently, the user is encouraged to try to correct the interference by one or more of the following measures: (1) re orient or relocate the receiving antenna; (2) increase the separation between the equipment and receiver; (3) connect the equipment to an outlet on a circuit other than the one to which the receiver is connected, or (4) consult the dealer or an experienced radio/tv technician for assistance. CAUTION: The user is cautioned that any changes or modifications not expressly approved by Paradox Security Systems could void the user's authority to operate/use the equipment.

## Patents

One or more of the following US patents may apply: 7046142, 6215399, 6111256, 5920259, 5886632, and RE39406. Canadian and international patents may also apply.

© 2015 Paradox Security Systems Ltd. All rights reserved. Specifications may change without prior notice. Paradox, StayD, Magellan and Spectra are trademarks or registered trademarks of Paradox Security Systems (Bahamas) Ltd. or its affiliates in Canada, the United States and/or other countries.

# Table of Contents

Warranty .....	0	<b>Arming &amp; Disarming</b> .....	<b>14</b>
Limitations of Alarm Systems.....	0	Regular Arming .....	14
Warning for Connections to Non-Traditional Telephony (e.g. VoIP).....	0	Sleep Arming .....	14
WARNINGS: Information to User.....	0	Stay Arming .....	14
Patents.....	0	Bypassing a Zone .....	15
<b>User Settings</b> .....	<b>2</b>	One-Touch Arming.....	15
<b>Zone Settings</b> .....	<b>3</b>	Auto-Arming .....	16
<b>User Codes</b> .....	<b>4</b>	Display Mode .....	16
Adding / Modifying a User.....	4	<b>Alarms</b> .....	<b>17</b>
Deleting a User .....	4	Alarm Display.....	17
<b>Setting the Time &amp; Date</b> .....	<b>5</b>	Disarming & Deactivating an Alarm .....	17
<b>Setting Chime Zones</b> .....	<b>5</b>	Panic Alarms.....	17
<b>Trouble Display</b> .....	<b>6</b>	Fire Alarms.....	17
<b>Keypads</b> .....	<b>7</b>	Testing & Maintenance .....	18
Auditory Feedback .....	7	<b>Communicating Through the Internet (IP100)</b> .....	<b>18</b>
Visual Feedback .....	7	<b>Communicating Using Text Messages (PCS100)</b> .....	<b>18</b>
Keypad Muting .....	7	<b>Communicating by Phone</b> .....	<b>20</b>
Keypad Backlight .....	8	<b>(Voice-Guided VDMP3)</b> .....	<b>20</b>
Power Save Mode (K32RF / K37 only) .....	8	VDMP3 Instructions Diagram.....	21
Keypad Overviews .....	9	<b>Advanced System Features</b> .....	<b>22</b>
<b>Remote Controls</b> .....	<b>12</b>	Programmable Outputs (PGMs) .....	22
Remote Control Feedback (REM2).....	12	Partitioning .....	22
<b>Arming &amp; Disarming with StayD</b> .....	<b>12</b>	Quick Function Keys .....	22
To Turn On/Off StayD Mode .....	12	<b>System Notes</b> .....	<b>22</b>
To Change Arm Mode.....	13	<b>Quick Programming</b> .....	<b>24</b>
Advanced StayD Settings .....	13	Master Quick Menus .....	24
		<b>Index</b> .....	<b>26</b>

# User Settings

For security reasons, write only the user's name and not their user code. 4-Digit Codes  6-Digit Codes

User # and Name	Partition 1	Partition 2	Byp*	Stay*	Force*	Arm* only	PGM* only	Duress*
01: Master Mas-	<input type="checkbox"/>	<input type="checkbox"/>	<input type="checkbox"/>	<input type="checkbox"/>	<input type="checkbox"/>	<input type="checkbox"/>	<input type="checkbox"/>	<input type="checkbox"/>
02: Master 1 Mas-	<input type="checkbox"/>	<input type="checkbox"/>	<input type="checkbox"/>	<input type="checkbox"/>	<input type="checkbox"/>	<input type="checkbox"/>	<input type="checkbox"/>	<input type="checkbox"/>
03: Master 2 Mas-	<input type="checkbox"/>	<input type="checkbox"/>	<input type="checkbox"/>	<input type="checkbox"/>	<input type="checkbox"/>	<input type="checkbox"/>	<input type="checkbox"/>	<input type="checkbox"/>
04: _____	<input type="checkbox"/>	<input type="checkbox"/>	<input type="checkbox"/>	<input type="checkbox"/>	<input type="checkbox"/>	<input type="checkbox"/>	<input type="checkbox"/>	<input type="checkbox"/>
05: _____	<input type="checkbox"/>	<input type="checkbox"/>	<input type="checkbox"/>	<input type="checkbox"/>	<input type="checkbox"/>	<input type="checkbox"/>	<input type="checkbox"/>	<input type="checkbox"/>
06: _____	<input type="checkbox"/>	<input type="checkbox"/>	<input type="checkbox"/>	<input type="checkbox"/>	<input type="checkbox"/>	<input type="checkbox"/>	<input type="checkbox"/>	<input type="checkbox"/>
07: _____	<input type="checkbox"/>	<input type="checkbox"/>	<input type="checkbox"/>	<input type="checkbox"/>	<input type="checkbox"/>	<input type="checkbox"/>	<input type="checkbox"/>	<input type="checkbox"/>
08: _____	<input type="checkbox"/>	<input type="checkbox"/>	<input type="checkbox"/>	<input type="checkbox"/>	<input type="checkbox"/>	<input type="checkbox"/>	<input type="checkbox"/>	<input type="checkbox"/>
09: _____	<input type="checkbox"/>	<input type="checkbox"/>	<input type="checkbox"/>	<input type="checkbox"/>	<input type="checkbox"/>	<input type="checkbox"/>	<input type="checkbox"/>	<input type="checkbox"/>
10: _____	<input type="checkbox"/>	<input type="checkbox"/>	<input type="checkbox"/>	<input type="checkbox"/>	<input type="checkbox"/>	<input type="checkbox"/>	<input type="checkbox"/>	<input type="checkbox"/>
11: _____	<input type="checkbox"/>	<input type="checkbox"/>	<input type="checkbox"/>	<input type="checkbox"/>	<input type="checkbox"/>	<input type="checkbox"/>	<input type="checkbox"/>	<input type="checkbox"/>
12: _____	<input type="checkbox"/>	<input type="checkbox"/>	<input type="checkbox"/>	<input type="checkbox"/>	<input type="checkbox"/>	<input type="checkbox"/>	<input type="checkbox"/>	<input type="checkbox"/>
13: _____	<input type="checkbox"/>	<input type="checkbox"/>	<input type="checkbox"/>	<input type="checkbox"/>	<input type="checkbox"/>	<input type="checkbox"/>	<input type="checkbox"/>	<input type="checkbox"/>
14: _____	<input type="checkbox"/>	<input type="checkbox"/>	<input type="checkbox"/>	<input type="checkbox"/>	<input type="checkbox"/>	<input type="checkbox"/>	<input type="checkbox"/>	<input type="checkbox"/>
15: _____	<input type="checkbox"/>	<input type="checkbox"/>	<input type="checkbox"/>	<input type="checkbox"/>	<input type="checkbox"/>	<input type="checkbox"/>	<input type="checkbox"/>	<input type="checkbox"/>
16: _____	<input type="checkbox"/>	<input type="checkbox"/>	<input type="checkbox"/>	<input type="checkbox"/>	<input type="checkbox"/>	<input type="checkbox"/>	<input type="checkbox"/>	<input type="checkbox"/>
17: _____	<input type="checkbox"/>	<input type="checkbox"/>	<input type="checkbox"/>	<input type="checkbox"/>	<input type="checkbox"/>	<input type="checkbox"/>	<input type="checkbox"/>	<input type="checkbox"/>
18: _____	<input type="checkbox"/>	<input type="checkbox"/>	<input type="checkbox"/>	<input type="checkbox"/>	<input type="checkbox"/>	<input type="checkbox"/>	<input type="checkbox"/>	<input type="checkbox"/>
19: _____	<input type="checkbox"/>	<input type="checkbox"/>	<input type="checkbox"/>	<input type="checkbox"/>	<input type="checkbox"/>	<input type="checkbox"/>	<input type="checkbox"/>	<input type="checkbox"/>
20: _____	<input type="checkbox"/>	<input type="checkbox"/>	<input type="checkbox"/>	<input type="checkbox"/>	<input type="checkbox"/>	<input type="checkbox"/>	<input type="checkbox"/>	<input type="checkbox"/>
21: _____	<input type="checkbox"/>	<input type="checkbox"/>	<input type="checkbox"/>	<input type="checkbox"/>	<input type="checkbox"/>	<input type="checkbox"/>	<input type="checkbox"/>	<input type="checkbox"/>
22: _____	<input type="checkbox"/>	<input type="checkbox"/>	<input type="checkbox"/>	<input type="checkbox"/>	<input type="checkbox"/>	<input type="checkbox"/>	<input type="checkbox"/>	<input type="checkbox"/>
23: _____	<input type="checkbox"/>	<input type="checkbox"/>	<input type="checkbox"/>	<input type="checkbox"/>	<input type="checkbox"/>	<input type="checkbox"/>	<input type="checkbox"/>	<input type="checkbox"/>
24: _____	<input type="checkbox"/>	<input type="checkbox"/>	<input type="checkbox"/>	<input type="checkbox"/>	<input type="checkbox"/>	<input type="checkbox"/>	<input type="checkbox"/>	<input type="checkbox"/>
25: _____	<input type="checkbox"/>	<input type="checkbox"/>	<input type="checkbox"/>	<input type="checkbox"/>	<input type="checkbox"/>	<input type="checkbox"/>	<input type="checkbox"/>	<input type="checkbox"/>
26: _____	<input type="checkbox"/>	<input type="checkbox"/>	<input type="checkbox"/>	<input type="checkbox"/>	<input type="checkbox"/>	<input type="checkbox"/>	<input type="checkbox"/>	<input type="checkbox"/>
27: _____	<input type="checkbox"/>	<input type="checkbox"/>	<input type="checkbox"/>	<input type="checkbox"/>	<input type="checkbox"/>	<input type="checkbox"/>	<input type="checkbox"/>	<input type="checkbox"/>
28: _____	<input type="checkbox"/>	<input type="checkbox"/>	<input type="checkbox"/>	<input type="checkbox"/>	<input type="checkbox"/>	<input type="checkbox"/>	<input type="checkbox"/>	<input type="checkbox"/>
29: _____	<input type="checkbox"/>	<input type="checkbox"/>	<input type="checkbox"/>	<input type="checkbox"/>	<input type="checkbox"/>	<input type="checkbox"/>	<input type="checkbox"/>	<input type="checkbox"/>
30: _____	<input type="checkbox"/>	<input type="checkbox"/>	<input type="checkbox"/>	<input type="checkbox"/>	<input type="checkbox"/>	<input type="checkbox"/>	<input type="checkbox"/>	<input type="checkbox"/>
31: _____	<input type="checkbox"/>	<input type="checkbox"/>	<input type="checkbox"/>	<input type="checkbox"/>	<input type="checkbox"/>	<input type="checkbox"/>	<input type="checkbox"/>	<input type="checkbox"/>
32: _____	<input type="checkbox"/>	<input type="checkbox"/>	<input type="checkbox"/>	<input type="checkbox"/>	<input type="checkbox"/>	<input type="checkbox"/>	<input type="checkbox"/>	<input type="checkbox"/>

\*Programmed by your installer.

# Zone Settings

Write the device type (motion detector, door contact etc.) and location.

Zone Number and Description	Partition 1 or 2	Byp	Stay	Sleep	Force	24Hr	Entry delay	Fire zone	Fire Delay
001: _____	_____	<input type="checkbox"/>	<input type="checkbox"/>	<input type="checkbox"/>	<input type="checkbox"/>	<input type="checkbox"/>	<input type="checkbox"/>	<input type="checkbox"/>	<input type="checkbox"/>
002: _____	_____	<input type="checkbox"/>	<input type="checkbox"/>	<input type="checkbox"/>	<input type="checkbox"/>	<input type="checkbox"/>	<input type="checkbox"/>	<input type="checkbox"/>	<input type="checkbox"/>
003: _____	_____	<input type="checkbox"/>	<input type="checkbox"/>	<input type="checkbox"/>	<input type="checkbox"/>	<input type="checkbox"/>	<input type="checkbox"/>	<input type="checkbox"/>	<input type="checkbox"/>
004: _____	_____	<input type="checkbox"/>	<input type="checkbox"/>	<input type="checkbox"/>	<input type="checkbox"/>	<input type="checkbox"/>	<input type="checkbox"/>	<input type="checkbox"/>	<input type="checkbox"/>
005: _____	_____	<input type="checkbox"/>	<input type="checkbox"/>	<input type="checkbox"/>	<input type="checkbox"/>	<input type="checkbox"/>	<input type="checkbox"/>	<input type="checkbox"/>	<input type="checkbox"/>
006: _____	_____	<input type="checkbox"/>	<input type="checkbox"/>	<input type="checkbox"/>	<input type="checkbox"/>	<input type="checkbox"/>	<input type="checkbox"/>	<input type="checkbox"/>	<input type="checkbox"/>
007: _____	_____	<input type="checkbox"/>	<input type="checkbox"/>	<input type="checkbox"/>	<input type="checkbox"/>	<input type="checkbox"/>	<input type="checkbox"/>	<input type="checkbox"/>	<input type="checkbox"/>
008: _____	_____	<input type="checkbox"/>	<input type="checkbox"/>	<input type="checkbox"/>	<input type="checkbox"/>	<input type="checkbox"/>	<input type="checkbox"/>	<input type="checkbox"/>	<input type="checkbox"/>
009: _____	_____	<input type="checkbox"/>	<input type="checkbox"/>	<input type="checkbox"/>	<input type="checkbox"/>	<input type="checkbox"/>	<input type="checkbox"/>	<input type="checkbox"/>	<input type="checkbox"/>
010: _____	_____	<input type="checkbox"/>	<input type="checkbox"/>	<input type="checkbox"/>	<input type="checkbox"/>	<input type="checkbox"/>	<input type="checkbox"/>	<input type="checkbox"/>	<input type="checkbox"/>
011: _____	_____	<input type="checkbox"/>	<input type="checkbox"/>	<input type="checkbox"/>	<input type="checkbox"/>	<input type="checkbox"/>	<input type="checkbox"/>	<input type="checkbox"/>	<input type="checkbox"/>
012: _____	_____	<input type="checkbox"/>	<input type="checkbox"/>	<input type="checkbox"/>	<input type="checkbox"/>	<input type="checkbox"/>	<input type="checkbox"/>	<input type="checkbox"/>	<input type="checkbox"/>
013: _____	_____	<input type="checkbox"/>	<input type="checkbox"/>	<input type="checkbox"/>	<input type="checkbox"/>	<input type="checkbox"/>	<input type="checkbox"/>	<input type="checkbox"/>	<input type="checkbox"/>
014: _____	_____	<input type="checkbox"/>	<input type="checkbox"/>	<input type="checkbox"/>	<input type="checkbox"/>	<input type="checkbox"/>	<input type="checkbox"/>	<input type="checkbox"/>	<input type="checkbox"/>
015: _____	_____	<input type="checkbox"/>	<input type="checkbox"/>	<input type="checkbox"/>	<input type="checkbox"/>	<input type="checkbox"/>	<input type="checkbox"/>	<input type="checkbox"/>	<input type="checkbox"/>
016: _____	_____	<input type="checkbox"/>	<input type="checkbox"/>	<input type="checkbox"/>	<input type="checkbox"/>	<input type="checkbox"/>	<input type="checkbox"/>	<input type="checkbox"/>	<input type="checkbox"/>
017: _____	_____	<input type="checkbox"/>	<input type="checkbox"/>	<input type="checkbox"/>	<input type="checkbox"/>	<input type="checkbox"/>	<input type="checkbox"/>	<input type="checkbox"/>	<input type="checkbox"/>
018: _____	_____	<input type="checkbox"/>	<input type="checkbox"/>	<input type="checkbox"/>	<input type="checkbox"/>	<input type="checkbox"/>	<input type="checkbox"/>	<input type="checkbox"/>	<input type="checkbox"/>
019: _____	_____	<input type="checkbox"/>	<input type="checkbox"/>	<input type="checkbox"/>	<input type="checkbox"/>	<input type="checkbox"/>	<input type="checkbox"/>	<input type="checkbox"/>	<input type="checkbox"/>
020: _____	_____	<input type="checkbox"/>	<input type="checkbox"/>	<input type="checkbox"/>	<input type="checkbox"/>	<input type="checkbox"/>	<input type="checkbox"/>	<input type="checkbox"/>	<input type="checkbox"/>
021: _____	_____	<input type="checkbox"/>	<input type="checkbox"/>	<input type="checkbox"/>	<input type="checkbox"/>	<input type="checkbox"/>	<input type="checkbox"/>	<input type="checkbox"/>	<input type="checkbox"/>
022: _____	_____	<input type="checkbox"/>	<input type="checkbox"/>	<input type="checkbox"/>	<input type="checkbox"/>	<input type="checkbox"/>	<input type="checkbox"/>	<input type="checkbox"/>	<input type="checkbox"/>
023: _____	_____	<input type="checkbox"/>	<input type="checkbox"/>	<input type="checkbox"/>	<input type="checkbox"/>	<input type="checkbox"/>	<input type="checkbox"/>	<input type="checkbox"/>	<input type="checkbox"/>
024: _____	_____	<input type="checkbox"/>	<input type="checkbox"/>	<input type="checkbox"/>	<input type="checkbox"/>	<input type="checkbox"/>	<input type="checkbox"/>	<input type="checkbox"/>	<input type="checkbox"/>
025: _____	_____	<input type="checkbox"/>	<input type="checkbox"/>	<input type="checkbox"/>	<input type="checkbox"/>	<input type="checkbox"/>	<input type="checkbox"/>	<input type="checkbox"/>	<input type="checkbox"/>
026: _____	_____	<input type="checkbox"/>	<input type="checkbox"/>	<input type="checkbox"/>	<input type="checkbox"/>	<input type="checkbox"/>	<input type="checkbox"/>	<input type="checkbox"/>	<input type="checkbox"/>
027: _____	_____	<input type="checkbox"/>	<input type="checkbox"/>	<input type="checkbox"/>	<input type="checkbox"/>	<input type="checkbox"/>	<input type="checkbox"/>	<input type="checkbox"/>	<input type="checkbox"/>
028: _____	_____	<input type="checkbox"/>	<input type="checkbox"/>	<input type="checkbox"/>	<input type="checkbox"/>	<input type="checkbox"/>	<input type="checkbox"/>	<input type="checkbox"/>	<input type="checkbox"/>
029: _____	_____	<input type="checkbox"/>	<input type="checkbox"/>	<input type="checkbox"/>	<input type="checkbox"/>	<input type="checkbox"/>	<input type="checkbox"/>	<input type="checkbox"/>	<input type="checkbox"/>
030: _____	_____	<input type="checkbox"/>	<input type="checkbox"/>	<input type="checkbox"/>	<input type="checkbox"/>	<input type="checkbox"/>	<input type="checkbox"/>	<input type="checkbox"/>	<input type="checkbox"/>
031: _____	_____	<input type="checkbox"/>	<input type="checkbox"/>	<input type="checkbox"/>	<input type="checkbox"/>	<input type="checkbox"/>	<input type="checkbox"/>	<input type="checkbox"/>	<input type="checkbox"/>
032: _____	_____	<input type="checkbox"/>	<input type="checkbox"/>	<input type="checkbox"/>	<input type="checkbox"/>	<input type="checkbox"/>	<input type="checkbox"/>	<input type="checkbox"/>	<input type="checkbox"/>

# User Codes

User codes are personal identification numbers for each user that allow you to enter certain programming modes, arm or disarm your system, as well as activate or deactivate PGMs. The system supports the following:

- 1 System Master Code
- 2 Master Codes
- 29 User Codes

## System Master Code (Default: 123456)

The System Master Code can arm or disarm any partition, and can create, modify or delete any user code.

## Master Codes

Master Code 1 is permanently assigned to Partition 1 and can be used to create, modify or delete user codes that are assigned to Partition 1. Master Code 2 is permanently assigned to Partition 2 (exception: when partitioning is disabled, Master Code 2 will be assigned to Partition 1) and can be used to create, modify or delete user codes that are assigned to the same partition.

**NOTE:** Master Codes cannot modify or delete user codes assigned to both partitions. Only the System Master Code can modify or delete user codes assigned to both partitions.

## Duress Code

If you are forced to arm or disarm your system, entering the user code with the duress option enabled will arm or disarm the system and immediately transmit a silent alert (Duress Code) to the monitoring station. The duress code must be enabled by your installer.

## User Code Length

Your system can be programmed to use either 4- or 6-digit user codes, where each digit can be any value from 0 to 9. Six-digit codes are considered more difficult to “crack” and therefore, more secure. Avoid programming simple or obvious user codes, such as your telephone number, address, or codes such as 1234.

## Adding / Modifying a User

<i>How do I add / modify a user?</i>	<i>Visual Feedback</i>
1 Press the [ <b>⏏</b> ] key.	
2 Enter your [ <b>MASTER CODE</b> ].	[ <b>⏏</b> ] and [ <b>1</b> ] flash. When a number on the keypad is lit, the user is already programmed.
3 Select a user by entering a 2-digit user number (01 to 32).	“Arm” flashes.
4 Enter a 4- or 6-digit [ <b>USER CODE</b> ].	“Sleep” flashes.
5 Confirm the [ <b>USER CODE</b> ].	“Stay” flashes.
6 To register a remote, press and hold any remote button for 3 seconds. Release. Press and hold any remote button for 3 seconds. If you do not wish to assign a remote, press [ <b>ENTER</b> ].	“Off” flashes.
7 To program another user, go to step 3. To exit, press [ <b>CLEAR</b> ]. For partitioned systems, continue to step 8.	
8 Press [ <b>1</b> ] and/or [ <b>2</b> ] to assign the user to a partition. Press [ <b>ENTER</b> ].	
9 To program another user, go to step 3. To exit, press [ <b>CLEAR</b> ].	

## Deleting a User

*How do I delete a user?*

- 1 Press the [**⏏**] key.
- 2 Enter your [**MASTER CODE**].
- 3 Select a user by entering a 2-digit user number.
- 4 Press and hold the [**SLEEP**] key until you hear the confirmation beep.

# Setting the Time & Date

How do I set the time & date?

---

- 1 Press the [⏻] key.
- 2 Enter your [MASTER CODE].
- 3 Press [TBL].
- 4 Press [5].
- 5 Enter time\* in the [HH.MM] format. If HH = 13 or more, skip to step 7.
- 6 Select time format. [1] = 24hr; [2] = AM; [3] = PM.
- 7 Enter the date in the [YYYY/MM/DD] format. You have now set the time & date. Press [CLEAR] to exit.

\*For SP4000 / SP65 systems, time must be entered in 24hr format. Omit step 6 (time format).

# Setting Chime Zones

A chime-enabled zone will advise you every time it is opened by causing your keypad to beep. Each keypad must be chimed separately.

How do I chime zones?

---

- **For K32, K32+ and K32RF:** Press & hold the [🔊] key. The Arm1, Arm2, Stay1, and Stay2 LEDs will flash. Enter the zone number corresponding to the zones you want to chime. The corresponding LED will light up. Press the [ENTER] key to exit.
- **For K35 and K37:** Press & hold the [🔊] key (K35) or [🔊] key (K37). The word *Chime* will appear on the screen. Enter the zone number corresponding to the zones you want to chime. The corresponding LED will light up. Press the [ENTER] key to exit. **Note:** K37 will only chime when powered by AC or when the display is active.
- **For K10V, K10H and K636:** Press & hold the zone key ([1] to [0(10)]). Accept beep = chime on.
- **For K32LCD, K32LCD+:** Press and hold the [🔊] key. Press [1] to select which zone to chime or press [2] to configure chime period. The chime period allows you to specify the time frame in which the zone will chime. Enter the zone number corresponding to the zones you want to chime. Press the [ENTER] key to exit.

How do I disable chime zones?

---

- **For K32, K32+,K32RF, K35, K37, K32LCD and K32LCD+:** To disable chime zones, repeat this process and enter the zone number to disable a chime zone, or press [SLEEP] to disable all chime zones instead of entering a zone number.
- **For K10V, K10H and K636:** Press & hold the zone key ([1] to [0(10)]). Fail beep = chime off.

**NOTE:** For a description of the confirmation and rejection beeps, see Keypad Feedback on page 7. To identify your keypad, see page 9.

# Trouble Display

Your alarm system continuously monitors several trouble conditions that can be reported directly to your monitoring station. When a trouble condition occurs, the **[TBL]** key will illuminate. Press the **[TBL]** key, and the keypad will illuminate a number corresponding to the trouble the system is experiencing. Except for the Timer Loss trouble, contact your monitoring station or installer to resolve the trouble condition.

**NOTE:** *If the keypad emits a BEEP every 5 seconds whenever a new trouble condition has occurred, press the **[TBL]** key to stop the “Trouble Beep”.*

## Accessing the Trouble Display

	Key / LED Lit	Trouble Type	Trouble Details
Press <b>[TBL]</b>	<b>[1]</b>	Wireless Zone Low Battery	The batteries for one of the system’s wireless devices needs to be replaced.
	<b>[2]</b>	Power Trouble	The control panel is experiencing power trouble.
	<b>[3]</b>	Bell Trouble	There is a bell disconnect/overload on the control panel.
	<b>[4]</b>	Communication Trouble	Your alarm system, if monitored, could not communicate with the monitoring station.
	<b>[5]</b>	Tamper/Zone Wiring Failure	A wiring problem is occurring on one or more devices.
	<b>[6]</b>	Module Tamper Trouble	A device’s anti-tamper switch has been triggered.
	<b>[7]</b>	Fire Loop Trouble	One of the zones is in fire loop trouble.
	<b>[8]</b>	Timer Loss	Your alarm system’s clock must be reprogrammed. See <i>Setting the Time and Date</i> on page 5 to set your system’s time and date.
	<b>[9]</b>	Wireless Zone Supervision Loss	One or more wireless zones are no longer communicating with the system.
	<b>[0 (10)]</b>	Module Supervision Loss	One or more modules are no longer communicating with the system.
	<b>[16] / [SLEEP]</b>	Keypad Fault	There is a problem with one of your system’s keypads



# Keypads

## Auditory Feedback

When you enter information on the keypad, it will guide you with beep tones that communicate confirmation or rejection of your entries. You should be familiar with these two keypad beep tones:

**Confirmation Beep:** When an operation (e.g. arming/disarming) is successfully entered on the keypad or when the system switches to a new status/mode, the keypad produces an intermittent beep tone (“BEEP-BEEP-BEEP-BEEP”).

**Rejection Beep:** When the system reverts to its previous status or when an operation is incorrectly entered on the keypad, it will emit a continuous beep tone (“BEEEEEEEEEP”).

The following are other types of auditory feedback, and will always be accompanied by the flashing of an arm key or LED ([**ARM**], [**STAY**], or [**SLEEP**]):

- Continuous beep = Alarm
- Variable beep = Fire alarm
- Intermittent beep = Beginning of exit delay
- Fast Intermittent beep = Last 10 seconds of exit delay

## Visual Feedback

The keypad includes colored lights which convey the current status of your system. The state of each light represents a specific condition in your system.

**NOTE:** *Many of the features in your system must be enabled by the installer. If the feature is not programmed, the keypad will emit a rejection beep and the action will be canceled. Refer to Zone Settings on page 3 for details.*

## Keypad Muting

When muted, the keypad will only emit the confirmation beep and rejection beep, and will beep when a key is pressed. Therefore, when muted, the keypad will not beep during an alarm and will not beep for chime enabled zones. Each keypad must be muted separately.

How do I mute the keypad?

- **For K32, K32+, K32RF, K35, K37, K636, K10V and K10H:** Press & hold the [CLEAR] key for 6 seconds to enable or disable keypad muting. If the keypad emits a confirmation beep, Keypad Muting is enabled for that keypad. If the keypad emits a rejection beep, the feature is disabled.

**For the K32LCD, K32LCD+:** Press and hold the [⊙] key for keypad settings. Press [4] for Mute Control. Press [arm] to enable or disable keypad muting.

## Keypad Backlight

The illumination level behind the keys can be modified to suit your needs.

*How do I modify the backlight?*

- **For K32, K32+ and K32RF:** Press and hold the [☉] key. Press the [☉] key to set the desired backlight level. Press [CLEAR] or [ENTER] to exit.

**For K35:** Press and hold the [▲] key for 4 seconds. Keys 1, 2, 3, 5 and 6 will flash. Press [CLEAR] to exit the menu without saving the information or press [ENTER] to exit the menu and save the information. Press the desired key and scroll using the [▲] and [▼] to adjust:

[1] To adjust the scrolling speed.

[2] To adjust the backlight (0 = Off, 1 = Lowest brightness / 7 = Maximum brightness)

[3] To adjust the contrast (0 = Low contrast, 4 = High contrast)

[5] To adjust the auto dim backlight level (0 = Off, 1 = Lowest auto dim backlight, (...) 7 = Highest auto dim backlight)

[6] To adjust the auto dim delay (0 = Off, 1 = 1 sec., 2 = 5 sec., 3 = 10 sec., 4 = 20 sec., 5 = 1 min., 6 = 2 min., 7 = 4 min.)

**For K37:** Press and hold the [▲] key for 4 seconds. Keys 1 and 2 will flash. Press [CLEAR] to exit the menu without saving the information or press [ENTER] to exit the menu and save the information. Press the desired key and scroll using the [▲] and [▼] to adjust:

[1] To adjust the backlight.

[2] To adjust the auto dim delay (5 = 5 sec. / 15 = 15 sec.)

**For the K10V, K10H and K636:** Press and hold the [MEM] key. The [MEM] key will illuminate. Press the [MEM] key to set the desired backlight level. Press [CLEAR] or [ENTER] to exit.

**For the K32LCD, K32LCD+:** Press and hold the [☉] key. Press [2] to modify the backlight. Scroll using the [▲] and [▼] keys. Press [ENTER] to save.

## Power Save Mode (K32RF / K37 only)

If DC power is not supplied to the wireless keypad, the module's display will shut off and go into power save mode after one minute (20 seconds for K37). Press the [i] key to activate the display.

# Keypad Overviews

## K636 Keypad Overview

**[TBL]** Trouble display  
 ON = Trouble(s) occurring (page 6)  
**[MEM]** Alarm memory display  
 ON = Alarm(s) occurred (page 17)  
**[BYP]** Bypass programming  
 ON = Zone(s) bypassed (page 17)

**Zone Display:**  
 The keys **[1]** to **[0(10)]** correspond to zones 1 to 10 respectively:  
 Key lit= Open or entry delay  
 Key flash= In alarm

 = Press once + **[MASTER CODE]** for Quick Menu Programming (see Master Quick Menus on page 24)



**IMPORTANT:** If installed on a partitioned system, the K636 will only display parti-

**[ARM]** (page 14)  
**[SLEEP]** (page 14)  
**[STAY]** (page 14)  
 ON = System armed  
 OFF = Zone disarmed  
 Flash = Exit Delay  
 Fast Flash = Exit Delay (final 10 sec.) / zone in alarm

**Off Key:**  
 ON= Disarmed  
 OFF = System armed  
**~ Light (AC):**  
 ON = Power on  
 OFF = Power off

**StayD Light:**  
 ON= StayD on  
 OFF= StayD off  
 (see StayD Mode on page 12)

## K10LEDV/H Keypad Overview

**[TBL]** Trouble display  
 ON = Trouble(s) occurring (page 6)  
**[MEM]** Alarm memory display  
 ON = Alarm(s) occurred (page 17)  
**[BYP]** Bypass programming  
 ON = Zone(s) bypassed (page 17)

**Zone Display:**  
 The keys **[1]** to **[0(10)]** correspond to zones 1 to 10 respectively:  
 Key lit= Open or entry delay  
 Key flash= In alarm

 = Press once + **[MASTER CODE]** for Quick Menu Programming (see Master Quick Menus on page 24)

Partition 1 Status      Partition 2 Status



**[ARM]** (page 14)  
**[SLEEP]** (page 14)  
**[STAY]** (page 14)  
 ON = System armed  
 OFF = Zone disarmed  
 Flash = Exit Delay  
 Fast Flash = Exit Delay (final 10 sec.) / zone in alarm

**Off Key:**  
 ON= Disarmed  
 OFF = System armed  
**~ Light (AC):**  
 ON = Power on  
 OFF = Power off

**StayD Light:**  
 ON= StayD on  
 OFF= StayD off  
 (see StayD Mode on page 12)

## K35 and K37 Keypad Overview



= Press once + [MASTER CODE] for Quick Menu programming (see Master Quick Menus on page 24)

= Press & hold for keypad settings

= Press & hold for chime programming (see Setting Chime Zones on page 5)



## K35 and K37 Icon Display and Description

K35

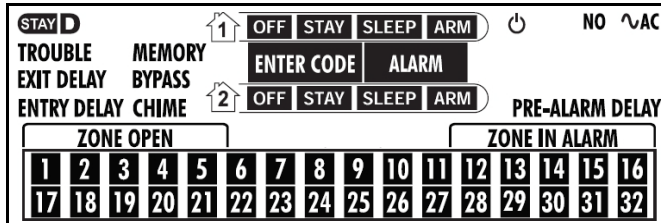

K37

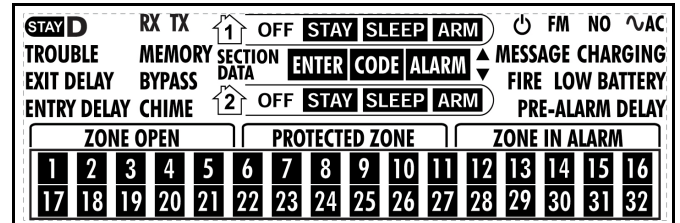

Icon	Description	Icon	Description
StayD	On = StayD mode enabled		Flashing = System is in Master Quick Menu mode
	Indicate Partition 1 and 2	EXIT DELAY	Flashing = Enter code before Exit Delay ends
OFF	On = System is disarmed	ENTRY DELAY	Flashing = Enter code before Entry Delay ends
STAY	On = System is Stay armed	ENTER CODE	On = Enter your user code
SLEEP	On = System is Sleep armed	MEMORY	On = Alarm(s) occurred
ARM	On = Partition is armed	BYPASS	On = Zone(s) bypassed
ALARM	Flashing = System is in alarm	CHIME	On = Displays chime zones when in Chime Prog. mode
PRE-ALARM DELAY	On = Countdown to alarm on Pre-Alarm zones	TROUBLE	Trouble flashes and number(s) corresponding to the trouble(s) illuminate (see Trouble List on page 6)
ZONE OPEN	On = Illuminated zone(s) are open	AC	On = AC power is supplied to the keypad
ZONE IN ALARM	On = Illuminated zone(s) are in alarm	NO AC	On = Keypad is running on backup battery power
TX (K37 only)	Flashing = Communication with panel in progress		

## K32, K32+ and K32RF Keypad Overview

Partition 1 Status      Partition 2 Status



Partition 1 Status      Partition 2 Status





Partition 1 Status      Partition 2 Status



**[TBL]** Trouble display  
ON = Trouble(s) occurring (page 6)  
**[MEM]** Alarm memory display  
ON = Alarm(s) occurred (page 17)  
**[BYP]** Bypass programming  
ON = Zone(s) bypassed (page 17)

**[ARM]** (page 14)  
**[SLEEP]** (page 14)  
**[STAY]** (page 14)  
ON = System armed  
OFF = Zone disarmed  
Flash = Exit Delay  
Fast Flash = Exit Delay (final 10 sec.) / zone in alarm

**Zone Display:**  
The keys [1] to [0(10)] correspond to zones 1 to 10 respectively:  
Key lit= Open or entry delay  
Key flash= In alarm

 = Press once + **[MASTER CODE]** for Quick Menu Programming (see Master Quick Menus on page 24)  
 = Press and hold to modify backlight (see page 8)

**Off Key:**  
ON= Disarmed  
OFF= System armed  
**AC Light (AC):**  
ON = Power on  
OFF = Power off

**StayD Light:**  
ON= StayD on  
OFF= StayD off (see StayD Mode on page 12)

**Power and Rx/Tx Light (K32RF only)**  
On = Power on  
Off = Power off  
Fast Flash = Transmission/Reception in progress  
Slow Flash = AC Loss on Keypad  
Info Key (K32RF only)  
Refresh display to see all open zones (see page 8)

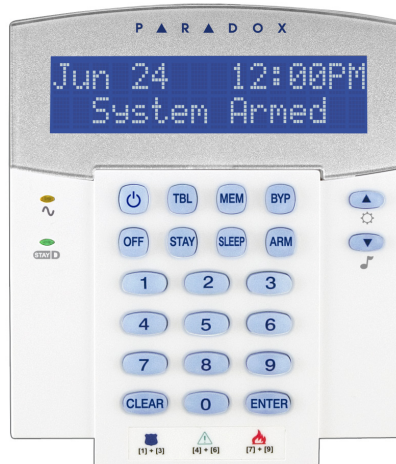

## K32LCD+ and K32LCD Keypad Overview



**Off Key:**  
ON= Disarmed  
OFF = System armed  
**AC Light (AC):**  
ON = Power on  
OFF = Power off

**StayD Light:**  
ON= StayD on  
OFF= StayD off (see StayD Mode on page 12)

**[TBL]** Trouble display  
ON = Trouble(s) occurring (page 6)  
**[MEM]** Alarm memory display  
ON = Alarm(s) occurred (page 17)  
**[BYP]** Bypass programming  
ON = Zone(s) bypassed (page 17)

 = Press once + **[MASTER CODE]** for Quick Menu Programming (see Master Quick Menus on page 24)  
 = Press and hold to modify back light (see page 8)  
 = Press and hold for chime programming (see page 5)

# Remote Controls

Your security system supports three types of remote controls; the REM1, REM2, REM3 and REM15. The REM1 and REM15 are the most basic remote controls, with the ability to perform five actions (e.g. arming, disarming, activating a PGM, etc.). The REM2 is more advanced, as it performs up to six different actions, as well as provides visual and auditory feedback (see table below). The REM3 is the most advanced remote control, as it has all the functionalities of a keypad (refer to the REM3 User Manual for more information). The following table describes the visual and auditory feedback of the REM2 remote control.

**NOTE:** A wireless expansion module is necessary in order to use remote controls if you are using a Spectra SP system. Please refer to your installer for more information regarding the use of remote controls with a Spectra SP system.

## Remote Control Feedback (REM2)

### Full/Force Arming Feedback

Action	Visual Feedback	Auditory Feedback
Disarming	Green on	Two beeps
Exit delay	Red / green slow flash	Confirmation beep
Arming / Entry Delay	Red on	Confirmation beep
Alarm	Red fast flash	Alarm beep

### Stay/Sleep Arming Feedback

Action	Visual Feedback	Auditory Feedback
Disarming	Green on	Two beeps
Exit delay	Yellow / green slow flash	Confirmation beep
Arming / Entry Delay	Yellow on	Confirmation beep
Alarm	Red fast flash	Alarm beep

### Other Feedback

Action	Visual Feedback	Auditory Feedback
PGM on/off	Yellow on	Confirmation beep

## Arming & Disarming with StayD

StayD simplifies your life and makes it safer by protecting you 24 hours a day, 7 days a week without ever having to disarm the system – even when entering an armed area. StayD lives with you and protects you at all times, without any unprotected periods, and automatically re-arms the system so you don't need to remember to.

When entering/exiting a site, the system partly disarms to let you pass through: simply notify the system with your remote and go through the designated path which will automatically re-arm after you pass. All other zones remain armed. The result is a system that is always protecting, without the uncertainty of whether the system is armed or not.

Other benefits of StayD include knowing when your kids are accessing potentially dangerous areas, such as the balcony, pool or front door. Now you can truly have peace of mind knowing that you are always protected. Consult your installer for more information.

### To Turn On/Off StayD Mode

#### To turn on StayD mode:

[STAY] + [CODE] + [STAY] → StayD light on

Press the [STAY] key followed by a valid code, then press the [STAY] key again within ten seconds. The StayD light will light up to confirm StayD activation, and the system will be in Stay mode.

### **To turn off StayD mode:**

**[OFF] + [CODE] + [OFF]** → Off light on

Press the **[OFF]** key followed by a valid code, then press the **[OFF]** key again within ten seconds. The StayD light will turn off and the Off light will light up to confirm StayD deactivation. With StayD disabled, the system will function as a standard security system.

### **To Change Arm Mode**

(see Arming & Disarming on page 14)

#### **To change the level of security - Stay to Sleep:**

**[SLEEP]** for 2 sec. → Delay → Sleep light on

Press and hold the **[SLEEP]** key on any keypad. All zones which will be armed in Sleep mode go into exit delay, allowing you to move to the bedroom. When the exit delay ends, and you are in the bedroom, the rest of the interior will arm. The system is now in Sleep mode.

#### **To change the level of security - Sleep to Stay:**

**[STAY]** for 2 sec. → Stay light on

Press and hold the **[STAY]** key on the keypad located in the bedroom. The system will instantly switch from Sleep to Stay mode, allowing you to leave the bedroom and move freely inside the house. If you accidentally leave the bedroom without switching to Stay mode, all zones armed in Sleep mode will go into a delay, allowing you enough time to switch to Stay mode.

#### **Leaving the site - Stay to Full:**

Keypad: **[ARM]** for 2 sec. → Delay → Arm light on

Press and hold the **[ARM]** key on the keypad that the exit path is assigned to. This will start an exit delay period for all zones in the exit path. After you have left the property, all exit path zones will rearm. The system is now in Full mode.

#### **Entering the site - Full to Stay:**

Keypad: **[CODE]** → Stay light on

When entering the property through the entry path, all zones assigned to the entry path will go into delay, allowing you to enter the house. Entering a valid code on the keypad the entry path is assigned to ends the entry delay and switches the system to Stay Arm mode. The entry path zones will rearm. The system is now in Stay mode.

#### **Leaving the site without changing arm mode:**

**[OFF]** for 2 sec.

Press and hold the **[OFF]** key for 2 seconds on a keypad to leave the site without changing arm mode.

## **Advanced StayD Settings**

### **Window Mode and Re-arm Delay**

In a Stay-armed system: This mode allows you to open one exterior zone without triggering an alarm. To enter Window mode, press **[OFF]**, then your **[USER CODE]**. All zones that can be opened flash. The system will start an exit delay, allowing you to open an exterior zone such as a window or a door. The system will only allow you to open one zone as the exit delay will end after doing so. When you close the open zone (window, door, etc.) that zone will re-arm.

When closing an exterior zone such as a window or door, a delay will start allowing you to close the zone properly. The re-arm delay starts when you close the zone, and you must keep the zone closed for the entire delay period for it to re-arm. This is especially useful for windows that stick thus reducing false alarms.

### **Live View Mode:**

During an alarm, press the **[CLEAR]** key to view the movement. The zone lights on the keypad will show the opening and closing of zones as they occur.

# Arming & Disarming

Take full advantage of your system by familiarizing yourself with all the arming methods. If your system is not partitioned (see Partitioning on page 22), everything is considered as belonging to Partition 1.

**NOTE:** *If you cannot arm because a zone is open, the system will enter in Bypass Programming. Enter the two digit zone you wish to bypass and press [ENTER], or press [ENTER] to bypass all open zones.*

## Regular Arming

This method will arm all the zones in the selected partition. Please note that Regular arming can also be activated using Auto-Arming (see Auto-Arming on page 16) or One-Touch Arming (see One-Touch Arming on page 15).

*How do I Regular arm?*

---

- 1 Close all zones in the desired partition.
- 2 Press **[ARM]** + **[USER CODE]**.
- 3 If you have access to both partitions (see Partitioning on page 22): Press the key corresponding to the desired partition (**[1]** or **[2]**). For both partitions, press the other key after the confirmation beep.

## Sleep Arming

Similar to Stay arming, Sleep arming allows users to remain in a protected area, but provides a higher level of protection. For example, in a two-story house, the perimeter is protected with Stay arming. With Sleep arming, the perimeter as well as the main floor are protected (motion detectors, etc.), allowing you to roam the second floor and sleeping quarters. Sleep zones are zones that are bypassed when Sleep arming. For example, when you go to sleep at night, the entire premises except your bedroom is fully armed. Sleep arming can also be activated using Auto-Arming (see Auto-Arming on page 16) or One-Touch Arming (see One-Touch Arming on page 15).

*How do I Sleep arm?*

---

- 1 Close all zones in the desired partition (except Sleep zones).
- 2 Press the **[SLEEP]** key.
- 3 Enter your **[USER CODE]**.
- 4 If you have access to both partitions (see Partitioning on page 22): Press the key corresponding to the desired partition, **[1]** or **[2]**. For both partitions, press the other key after the confirmation beep.

## Stay Arming

This method allows you to roam freely within the premises while the perimeter is fully armed. Stay zones are zones that are bypassed when Stay arming. For example, if you plan on staying in for the night, doors and windows can be armed without arming other zones like motion detectors. Stay arming can also be activated using Auto-Arming (see Auto-Arming on page 16) or One-Touch Arming (see One-Touch Arming on page 15).

*How do I Stay arm?*

---

- 1 Close all zones in the desired partition (except Stay zones).
- 2 Press the **[STAY]** key.
- 3 Enter your **[USER CODE]**.
- 4 If you have access to both partitions (see Partitioning on page 22): press the key corresponding to the desired partition, **[1]** or **[2]**. For both partitions, press the other key after the confirmation beep.



## Bypassing a Zone

Bypassing a zone allows you to ignore (deactivate) specified zones the next time the system is armed. For example, you may wish to bypass certain zones when workers are renovating part of your home. Once the system is disarmed, the bypass entries are erased. When zones are bypassed, the **[BYP]** key will illuminate. Zone bypassing can also be activated by using One-Touch Bypass Programming (see page 15). If One-Touch Bypass Programming is enabled, press the **[BYP]** key for three seconds to enter bypass programming. To remove the Bypass feature from a zone, in step 3 enter the zone number again or press **[CLEAR]** to erase all current entries. Press **[CLEAR]** + **[ENTER]** to delete bypassed zones.

### *How do I bypass zones?*

---

- 1 Press the **[BYP]** key.
- 2 Enter **[USER CODE]**. The **[BYP]** key will flash. Press **[ENTER]** to bypass all open zones or go to step 3.
- 3 Illuminate the number(s) corresponding to the zone(s) you want to bypass by entering the zone number. Solid on = Zone open, Flash = Zone bypass, Off = Zone closed, not bypassed.
- 4 Press the **[ENTER]** key to save and exit. Press **[CLEAR]** twice to exit without saving.

## Bypass Recall Feature

After disarming the system, bypass entries are erased. The Bypass Recall feature reinstates the previous bypass entries saved in memory. This eliminates the need to manually re-program the bypass entries every time you arm your system.

### *How do I recall bypass entries?*

---

- 1 Press the **[BYP]** key.
- 2 Enter your **[USER CODE]**.
- 3 Press the **[BYP]** key.
- 4 Press the **[ENTER]** key.

## One-Touch Arming

One-Touch arming allows you to arm the system without using a user code. This feature must be enabled by your installer. If One-Touch Arming is programmed, you can increase the security level of your system (from Disarm → Stay Arm → Sleep Arm → Full Arm) without a code. See Figure 1 below.

### One-Touch Regular Arming

Press and hold the **[ARM]** key to arm all zones in the partition. If partitioned, keys **[1]** & **[2]** will flash. You can use this feature to allow specific individuals like service personnel (e.g. cleaners) to arm without giving them access to any other alarm system operations. See Regular Arming on page 14.

### One-Touch Stay Arming

Press and hold the **[STAY]** key to arm the perimeter (no Stay zones). See Stay Arming on page 14.

### One-Touch Sleep Arming

Press and hold the **[SLEEP]** key to arm all zones not defined as Sleep zones. See Sleep Arming on page 14.

### One-Touch Bypass Programming

Press and hold the **[BYP]** key to access Bypass programming mode. See Bypassing a Zone on page 17.

## Fast Exit

When the system is already Stay or Sleep armed: this feature will allow you to exit already armed premises and keep the system armed. Press and hold the **[OFF]** key for to start the exit delay. After the exit delay has elapsed, the system will switch to its previous arming mode.

Figure 1: Arming / Disarming

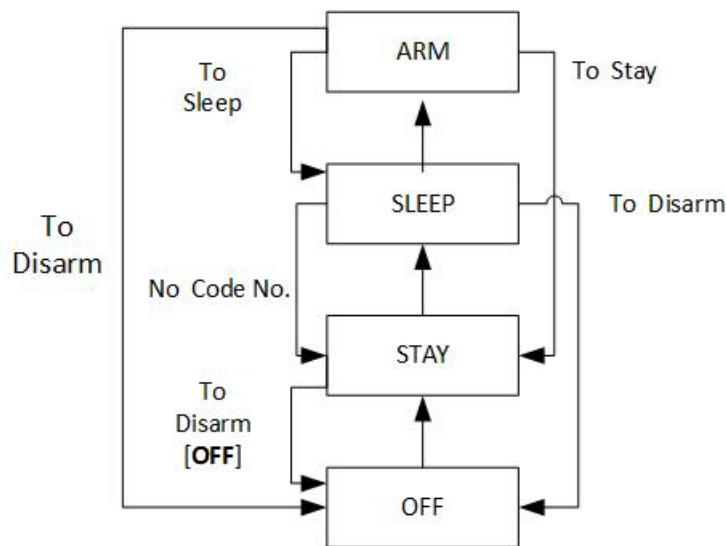

## Auto-Arming

### Timed Auto Arming

The alarm system can automatically arm itself at a specified time every day. As with Regular arming (see Regular Arming on page 14), the system will bypass any open zones.

*How do I program the Auto-Arm Timer?*

- 1 Press the [⏻] key.
- 2 Enter [MASTER CODE].
- 3 Press the [BYP] key. The [BYP] key will flash.
- 4 Press key [1] to set partition 1, or press key [2] to set partition 2.
- 5 Enter the desired time for auto arm (24 hour clock, e.g. 18:30).
- 6 Press key [1] to regular arm, key [2] to sleep arm, or key [3] to stay arm the partition.

*How do I temporarily disable the Auto-Arm Timer?*

- 1 Press the [⏻] key.
- 2 Enter [MASTER CODE].
- 3 Press the [BYP] key. The [BYP] key will flash.
- 4 Press key [1] to set partition 1, or press key [2] to set partition 2.
- 5 Press and hold [SLEEP] to temporarily disable the Auto-Arm Timer.

### No Movement Auto Arming

The alarm system can be programmed to arm the system and/or send a report to your monitoring station if no zone activity occurs for a pre-programmed amount of time. This is a particularly useful feature when supervising an individual with chronic health problems or for a person who lives alone. The system will bypass any open zones.

## Display Mode

The K32RF has two display modes. By default, the keypad will show all events (e.g. zones in alarm, bypassed zones, etc.) live as they occur. Alternatively, the system can be programmed by your installer to only display zones that cause an alarm or entry delay. If you want to see the status of all zones, press the [i] key. Zones that are open but have not triggered an alarm will only be displayed after pressing the [i] key. The information will be displayed for 30 seconds (20 seconds for K37), showing the status of all zones at the time the [i] key was pressed. The zone display will shut off after 30 seconds (20 seconds for K37). For more information on the two display modes, contact your installer.

# Alarms

## Alarm Display

If an alarm has occurred on a zone, the respective zone key will flash, the **[MEM]** key will light up, and the zones will be stored in memory. These respective keys will continue to flash until disarming even if the zones are restored. To exit this mode and switch to live display mode before disarming, press the **[CLEAR]** key. When the system is disarmed, the zone keys will turn off, while the **[MEM]** key remains lit. Press the **[MEM]** key to illuminate the key corresponding to the zones that were in alarm. The alarm memory will be erased when the next alarm occurs and after a valid code is entered or upon full-arming the system.

## Disarming & Deactivating an Alarm

To disarm an armed system or an alarm, press **[OFF]** and enter your **[USER CODE]**. An entry point, like the front door, will be programmed with one of two Entry Delay Timers. When an entry point is opened, the keypad will beep until you disarm the system. Your alarm system will not generate an alarm until this timer elapses. Any user can disarm a partition they have been assigned to, except users assigned with the Arm Only Option or PGM Only Option.

*How do I disarm the system?*

- 
- Press **[OFF]** + enter **[USER CODE]**.

## Panic Alarms

In case of an emergency, the system can provide three panic alarms that can immediately generate an alarm after simultaneously pressing and holding two specific keys for three seconds. Based on your needs, these panic alarms can generate audible alarms (sirens or bells) or silent alarms and can communicate specific messages to your monitoring station. For instance, pressing **[1]** and **[3]** can mean “call the police” or anything you require. This feature must be set by your installer.

Press and hold keys **[1]** and **[3]** for Panic type 1 (e.g. police).

Press and hold keys **[4]** and **[6]** for Panic type 2 (e.g. medical).

Press and hold keys **[7]** and **[9]** for Panic type 3 (e.g. fire).

## Fire Alarms

Upon a fire alarm, the bell/siren will emit three “squawks” at 2 second intervals until silenced or reset by entering a valid user code. If the zone is a Delayed Fire Zone, there is a delay before the system contacts the monitoring station. This will prevent unnecessary reporting of false alarms. If there is no fire condition, contact your monitoring station immediately to avoid an unnecessary response.

*What do I do if a delayed fire zone was set off accidentally?*

- 
- 1 Press the **[CLEAR]** key within 30 seconds of the alarm.
  - 2 Try to correct the problem.
  - 3 If the problem persists, after 90 seconds, the alarm will sound again. Press the **[CLEAR]** key again.

## Minimizing Fire Hazards

The three most common causes of fires:

Cooking is the leading cause of home fires in the U.S. It's also the leading cause of fire injuries. Cooking fires often result from unattended cooking and human error, rather than mechanical failure of stoves or ovens. Careless smoking is the leading cause of fire deaths. Smoke detectors and smolder-resistant bedding and upholstered furniture are significant fire deterrents. Heating is the second leading cause of residential fires. However, heating fires are a larger problem in single family homes than in apartments since the heating systems in single family homes are often not professionally maintained.

## Fire Safety Tips

In the event of a fire, escape first, then call for help. Develop a home fire escape plan and designate a meeting place outside. Make sure everyone in the family knows two ways to escape from every room. Practice feeling your way out with your eyes closed. Never stand up in a fire, always crawl low under the smoke and try to keep your mouth covered. Never return to a burning building for any reason; it may cost you your life. Finally, having at least one working smoke alarm dramatically increases your chances of surviving a fire. And remember to practice a home escape plan frequently with your family.

## Providing a Fire Warning System

Household fires are especially dangerous at night. Fires produce smoke and deadly gases that can overcome occupants while they sleep. To warn against fire, smoke detectors should be installed outside each separate sleeping area in the immediate vicinity of the bedrooms and on each additional story of the family living unit, including basements.

## Testing & Maintenance

With the system disarmed and the “OFF” light illuminated, activate motion detectors by walking in the protected area. Open and close protected doors and verify that the corresponding lights illuminate. Your installer can advise you of the best way to test your particular system.

Do not use open flame or burning materials to test your fire detection devices. Contact your installer for safe methods of testing your system.

Under normal use, your system requires virtually no maintenance other than regular testing. It is recommended that the standby battery be changed every three years. Speak to your installer about the necessary tests and how often they should be performed.

## Communicating Through the Internet (IP150)

You can communicate with your security system via the internet by using a system accessory called the IP150 Internet Module (sold separately). The IP150 controls and monitors your security system remotely through any web browser. It allows for email notifications of important system events such as alarms, arm/ disarm events, and troubles. For example, receive an email at work when your kids get back from school, or if an alarm occurs in your system at home.

You can also view live status of your system and arm/disarm your system. For example, you have just left your office for the weekend but are not sure you remembered to arm it. Simply check the status of your system from a laptop and arm it remotely. There is no PC software to install, as the IP150 is web-based. It uses a user-friendly web-page that puts you in control. Consult your installer or refer to the IP150 User manual for more information.

## Communicating Using Text Messages (PCS250/PCS250G)

You can communicate with your security system using text messages (SMS) by using system accessories called PCS250/PCS250G GSM modules (sold separately). The GSM module allows you to receive text messages of system events, such as alarms or troubles, on your cellular phone. It also allows you to send text messages to arm or disarm your system from anywhere in the world. Consult your installer for more information.

### Receiving Text Messages

To receive text messages from your system you need to:

- Program the telephone numbers you wish to receive text notifications.
- Select which event groups (alarm, arm/disarm, trouble and trouble restore) will generate text messages.
- Select which partition the phone number is assigned to.

*How do I set up the GSM module to send me text messages?*

- 1 Press the [⏏] key.
- 2 Enter [MASTER CODE].
- 3 Press [ARM].

- 4 Using the [▲] / [SLEEP] and [▼] / [STAY] keys or by entering [01] to [08], select one of the eight telephone numbers you wish to program and press [ENTER].
- 5 Enter the telephone number and press [ENTER].
- 6 Select the which group of events will send a text message to the phone number set in step 5 (see Event Call options below).
- 7 Press [ENTER].
- 8 Select which partition(s) is assigned to this telephone number by pressing [1], [2], or both.
- 9 To save, press [ENTER].

#### Event Call Options

Option	Events that send a text message
[1]	Any alarm (e.g. fire, burglary etc.)
[2]	Arming and disarming
[3]	Any trouble (e.g. battery loss)
[4]	Any trouble restore (e.g. battery restored)

### Sample Text Messages

Alarm message

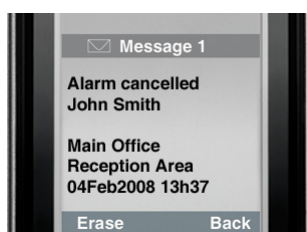

Arming / disarming message

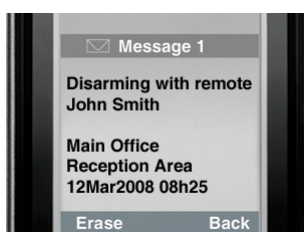

Trouble message

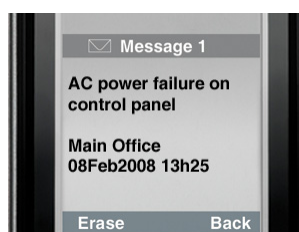

Trouble restore message

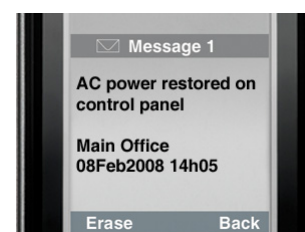

### Sending Text Messages to Arm / Disarm

You can arm or disarm the system by sending a text message (SMS) from any cell phone. The message must be sent to the GSM module's phone number, as determined by the cell phone provider (consult your installer for more information). Text message commands have a specific format which follows this pattern:

C[USER CODE].[ACTION].A[PARTITIONS].[PHONE NUMBER]

**NOTE:** SMS commands must be entered in capital letters.

Example: C1234.ARM.A1.5555551234  
C1234.OFF.A1.5555551234

In the example above, user code 1234 will arm or disarm partition 1, and the confirmation message will be sent the following phone number: (555) 555-1234.

#### User Code

The first part of the text message is the user code (same code used on the alarm system). It must be prefaced with the letter C and followed by a period.

Example: **C1234.**

#### Action

It is possible to arm or disarm the system. The command must be entered after the user code and followed by a period. To arm the system, enter the ARM command. To disarm the system, enter the OFF command.

Example: C1234.**ARM.**

## Partition

It is possible to arm or disarm specific partitions. The partitions must be prefaced by the letter A, and separated by commas for individual partitions. It is also possible to affect a series of partitions by writing TO between the start and end partitions of that series. The list of partitions must be followed by a period.

Examples: C1234.ARM.**A1**.

C1234.ARM.**A1TO2**.

## Phone Number

This informs the system of which phone number must be notified by SMS to confirm the status change.

Example: C1234.ARM.A1,3,5TO7.**5555551234**

## IP Information

It is possible to receive the IP address of the GSM module via text message. The GSM module will then send a text message to the specified phone number displaying the IP address of the GSM module. A valid user code must be entered to receive the IP address. The IP address can be used to configure remote software. Consult your installer for more information.

Example: C1234.IP.5555551234

## GSM Module Phone Number

Enter the phone number of your GSM module here (consult your cell phone provider)

---

# Communicating by Phone (Voice-Guided VDMP3)

You can communicate with your security system by phone by using a system accessory called the VDMP3 Voice Dialer (sold separately). The VDMP3 is a module that can be programmed to call one or more telephone numbers in the event of an alarm. For example, when an alarm occurs at your store during off-hours, every employee can receive notification via telephone: (sample message) "Area 1 in alarm. Zone 3. Press 1 to disarm the system..."

You can also call the VDMP3 from an outside line, enabling you to arm or disarm the system as well as activate PGMs. The VDMP3 essentially turns any outside telephone into a keypad. For example, you unexpectedly have to extend a business trip, and for security reasons, would like to turn on your office's lighting. Simply use your phone to toggle the lights on and off. Consult your installer for more information.

## VDMP3 Instructions

### *How do I call the VDMP3?*

---

- 1 From an outside line, dial the telephone number to which the VDMP3 is associated.  
**NOTE:** If the telephone number that is associated with the VDMP3 has an answering machine, hang up the telephone when the line rings, and dial the telephone number again within the time limit set by your installer.
- 2 When the VDMP3 answers the line, you are prompted to enter your user code.
- 3 System status is given, as well as options to arm/disarm (1) and control features (PGMs) (2).  
**NOTE:** If you hang up while in communication with the VDMP3, you must wait 2 minutes before connecting again. To avoid having to wait, press "#" to disconnect from the VDMP3 before hanging up.

Refer to the following page for a diagram that details how to use the VDMP3.

Calling the VDMP3

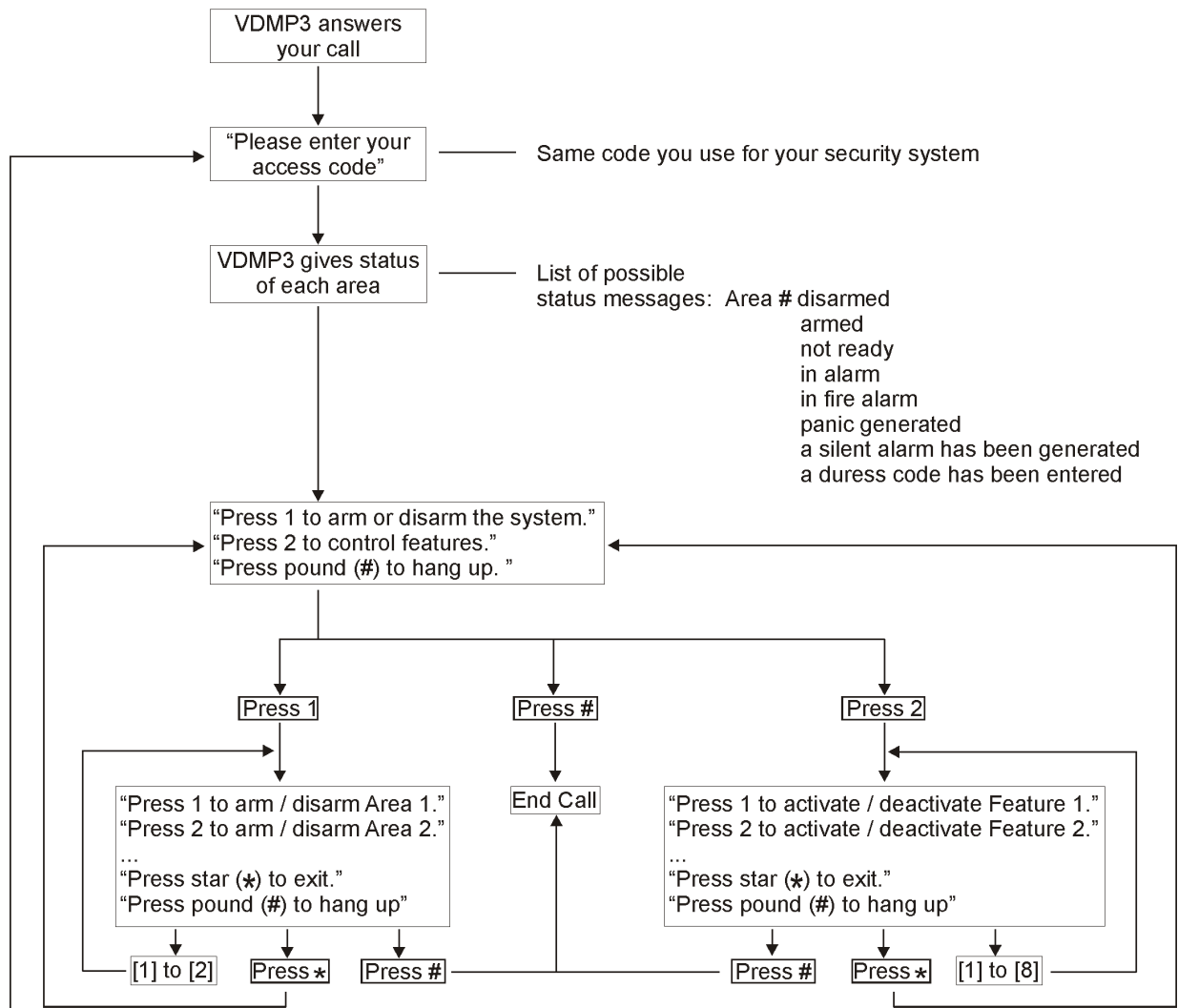

Receiving a Call From the VDMP3

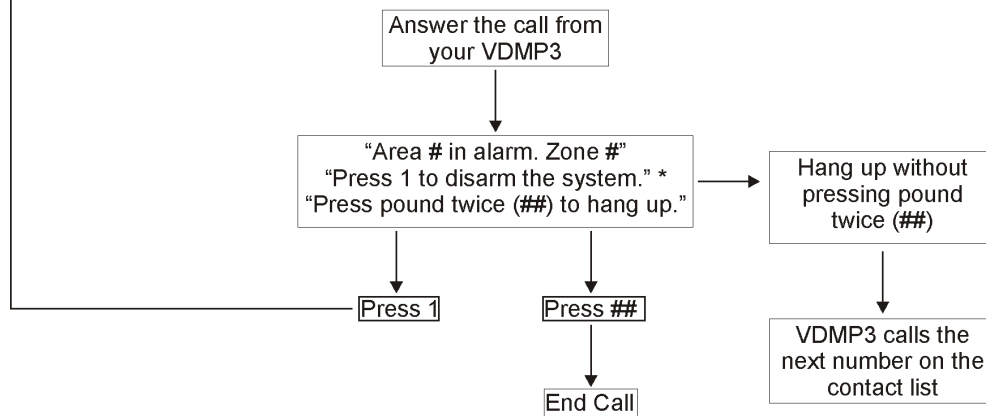

\* If multiple areas are in alarm, the VDMP3 hangs up and calls back to report other alarms.

# Advanced System Features

## Programmable Outputs (PGMs)

Your system may include one or more PGMs. When a specific event or condition occurs in the system, The PGM can be used to reset smoke detectors, activate light switches in your home or office, open/close garage doors and much more. If programmed by your installer, you can press and hold keys **[1] & [2]**, **[2] & [3]**, **[4] & [5]**, **[5] & [6]**, **[7] & [8]**, or **[8] & [9]** for each respective PGM. Press and hold **[CLEAR] + [ENTER]** or **[⏏]** for three seconds to perform a smoke reset. These features must be set by your installer.

## Partitioning

Your system is equipped with a partitioning feature that can divide your alarm system into two distinct areas identified as Partition 1 and Partition 2. When partitioned, each zone, each user code and many of your system's features can be assigned to either Partition 1, Partition 2, or both partitions.

**NOTE:** *If the system is not partitioned, all zones, user codes, and features will be recognized as belonging to Partition 1. Partitioning is not available when using a K636 keypad.*

## Quick Function Keys

Upon request of your installer or monitoring station you may have to perform one of the following. To enter Menu Programming, press **[⏏]** and then enter your **[MASTER CODE]**. In Menu programming, press:

### Test Report

**[MEM] + [2]**

If your system is monitored by a monitoring station, this feature will send a test report code to the monitoring station.

### Call PC

**[MEM] + [1]**

Will initiate a call to the monitoring station that is using the WinLoad software.

### Answer PC

**[MEM] + [1]**

Will force your security system to answer a call made by your monitoring station that is using the WinLoad software.

### Cancel Communication

**[MEM] + [9]**

Cancels all communication with the WinLoad software if it has been initiated.

# System Notes

## Zone Description

Is this system partitioned? Yes  No

Partition 1 = \_\_\_\_\_

Partition 2 = \_\_\_\_\_

## Special Keys and Features

- [ARM]** One-Touch Regular arming is activated
- [STAY]** One-Touch Stay arming is activated
- [SLEEP]** One-Touch Sleep arming is activated
- [BYP]** One-Touch Bypass Programming is activated

## Panic Alarms

**[1] & [3]** Police or \_\_\_\_\_  Audible  Off  Report only



[4] & [6] Aux. or \_\_\_\_\_  Audible  Off  Report only

[7] & [9] Fire or \_\_\_\_\_  Audible  Off  Report only

**PGMs**

PGM 1 \_\_\_\_\_ PGM 2 \_\_\_\_\_ PGM 3 \_\_\_\_\_ PGM 4 \_\_\_\_\_  
PGM 5 \_\_\_\_\_ PGM 6 \_\_\_\_\_ PGM 7 \_\_\_\_\_ PGM 8 \_\_\_\_\_  
PGM 9 \_\_\_\_\_ PGM 10 \_\_\_\_\_ PGM 11 \_\_\_\_\_ PGM 12 \_\_\_\_\_  
PGM 13 \_\_\_\_\_ PGM 14 \_\_\_\_\_ PGM 15 \_\_\_\_\_ PGM 16 \_\_\_\_\_

**PGM Utility Keys**

[1] & [2]: \_\_\_\_\_ [2] & [3]: \_\_\_\_\_  
[4] & [5]: \_\_\_\_\_ [5] & [6]: \_\_\_\_\_  
[7] & [8]: \_\_\_\_\_ [8] & [9]: \_\_\_\_\_

[CLEAR] + [ENTER] = Smoke Reset

**System Timers**

Enter and exit your premises through the designated doors.

Exit Delay 1 (Partition 1): \_\_\_\_\_ sec. = time to exit premises

Exit Delay 2 (Partition 2): \_\_\_\_\_ sec. = time to exit premises

Entry Delay 1 = \_\_\_\_\_ sec. = time to disarm before alarm; enter through zone # \_\_\_\_\_

Entry Delay 2 = \_\_\_\_\_ sec. = time to disarm before alarm; enter through zone # \_\_\_\_\_

Alarm will activate siren or bell for \_\_\_\_\_ min.

**GSM Module Phone Number**

Enter the phone number of your GSM module here (consult your cell phone provider)

\_\_\_\_\_

**Other Information**

Installed by: \_\_\_\_\_

Date: \_\_\_\_\_

Serviced by: \_\_\_\_\_

Telephone: \_\_\_\_\_

Monitored by: \_\_\_\_\_

Telephone: \_\_\_\_\_

Your account number: \_\_\_\_\_

Alarm transformer location: \_\_\_\_\_

On circuit #: \_\_\_\_\_

Location of Telephone Connections: \_\_\_\_\_

# Quick Programming

## Master Quick Menus

### User

Step	Action	Details
1	[⏏] + [MASTER CODE]	The [⏏] key will flash. LED/key on = programmed user. [PARTITION MASTER CODE] may also be used.
2	[USER NUMBER]	2 digits: 01 to 32.
3	[CODE]	Enter a 4 or 6-digit code.
4	[CONFIRM CODE]	Re-enter 4 or 6-digit code.
5	ASSIGN REMOTE	Press any remote button twice. If you do not wish to assign a remote, press [ENTER].
6		To program another user, go to step 2. To exit, press [CLEAR]. For partitioned systems, continue to step 7.
7	[1] and/or [2] + [ENTER]	Assign the user to one or both partitions and press [ENTER]. By default, users are assigned to partition 1. Goes to next available user.

### Delays

Step	Action	Details
1	[⏏] + [MASTER CODE]	The [⏏] key will flash.
2	[TBL]	
3	[1] = Entry Delay 1 (sec.) [2] = Entry Delay 2 (sec.) [3] = Exit Delay (sec.) [4] = Bell Cut-Off (min.)	Default = 045 sec. Default = 045 sec. Default = 060 sec. Default = 004 min.
4	[000] to [255]	___/___/___ Enter a value between 000 and 255

### Time and Date

Step	Action	Details
1	[⏏] + [MASTER CODE]	The [⏏] key will flash.
2	[TBL] + [5]	
3	[HH:MM]*	Enter time using the 24 hour format (e.g. 18:00 for 6:00 pm). *For SP4000 / SP65 systems, time must be entered in 24hr format.
4	[1] = 24 Hour [2] = AM; [3] = PM	Select time format. Omit step 4 (time format).
5	[YYYY/MM/DD]	Enter date.

### Communicate with WinLoad / GSM

Step	Action	Details
1	[⏏] + [MASTER CODE]	The [⏏] key will flash.
2	[MEM]	
3	[1] = Start communication [2] = Test Report [9] = Cancel communication	

### System Options

Step	Action	Details
1	[⏏] + [MASTER CODE]	The [⏏] key will flash.
2	[BYP]	
3	[4] = [5] = [6] =	Toggle to have the siren squawk on arm/disarm with keypad. Toggle to have the siren squawk on arm/disarm with remote. Toggle to have no exit delay when arming with remote.

## Assigning a REM3 Hand-Held 2-Way Remote Keypad to the Panel

Step	Action	Details
1	[⏻] + [MASTER CODE]	The [⏻] key will flash. LED/Key on = programmed user [PARTITION MASTER CODE] may also be used.
2	[USER NUMBER]	2 digits: 01 to 32
3	[CODE]	Enter 4- or 6-digit code.
4	[CONFIRM CODE]	Re-enter 4- or 6-digit code.
5	[LEARN REMOTE]	Press and hold the Information key ([i]) on the designated remote.
6	[1] and/or [2] + [ENTER]	Assign the user to one or both partitions and press [ENTER]. By default users are assigned to partition 1. Goes to the next available user.

## Communicator

Step	Action	Details
1	[⏻] + [MASTER CODE]	The [⏻] key will flash.
2	[MEM]	
3	[3] = Personal Phone #1 [4] = Personal Phone #2 [5] = Personal Phone #3 [6] = Personal Phone #4 [7] = Personal Phone #5 [8] = Pager #	
4	[PHONE #] + [ENTER]	Enter phone # (up to 32 digits) and press [ENTER]. Goes to next phone#, or go to step 5 if [8] = Pager # was selected.
5	[MESSAGE] + [ENTER]	Step 5 for Pager # only. Enter pager message and press [ENTER].

## Test Report

Step	Action	Details
1	[⏻] + [MASTER CODE]	The [⏻] key will flash.
2	[MEM]	Press the [MEM] key
3	[2]	Send a test report to the monitoring station.

## Auto Arm

Step	Action	Details
1	[⏻] + [MASTER CODE]	The [⏻] key will flash.
2	[BYP]	
3	[1] = Auto arm (partition 1) [2] = Auto arm (partition 2)	
4	[HH:MM]	Enter time using the 24 hour format (e.g. 18:00 for 6:00 pm).
5	[1] = Regular arm [2] = Sleep arm [3] = Stay arm	

## Erase Lost Remote Control

Step	Action	Details
1	[⏻] + [MASTER CODE]	
2	[BYP]	
3	[3]	
4	[ALL REMOTES] + [ENTER]	Press a button on all remotes. Press [ENTER]
5	Press and hold [SLEEP] (3sec)	Press and hold [SLEEP] to erase all lost remotes.

# Index

<b>A</b>			
Access Code Length .....	4	Internet .....	18
Adding a User .....	4	IP100 .....	18
Advanced StayD .....	13	<b>K</b>	
Advanced System Features .....	22	K10LEDV/H .....	9
Alarm Display .....	17	K32 .....	11
Alarms .....	17	K32I .....	10
Arming .....	14	K32IRF .....	10
Arming & Disarming .....	14	K32LCD .....	11
Arming & Disarming with StayD .....	12	K32RF .....	11
Auditory Feedback .....	7	K636 .....	9
Auto Arm .....	25	Keypad .....	9
Auto-Arming .....	16	Keypad Backlight .....	8
		Keypad Feedback .....	7
<b>B</b>		Keypad Muting .....	7
Backlight .....	8	Keypads .....	7
Bypass Recall .....	15	Keys .....	22
Bypass Recall Feature .....	15	<b>L</b>	
Bypassing a Zone .....	15	Limitations .....	0
		Live View Mode .....	13
<b>C</b>		<b>M</b>	
Chime Zones .....	5	Maintenance .....	18
Communicate .....	24	Manual Bypass .....	17
Communicating by Phone (VDMP3) .....	20	Master Code .....	4
Communicating Through the Internet (IP100) .....	18	Master Codes .....	4
Communicating Using Text Messages (PCS100) .....	18	Master Quick Menus .....	24
Communicator .....	25	Messages .....	18
		<b>N</b>	
<b>D</b>		No Movement Auto Arming .....	16
Date .....	5	<b>O</b>	
Deactivating an Alarm .....	17	One-Touch Arming .....	15
Delays .....	24	One-Touch Bypass Programming .....	15
Deleting a User .....	4	One-Touch Force Arming .....	15
Diagram .....	21	One-Touch Stay Arming .....	15
Disarming .....	14, 17	Overviews .....	9
Display .....	17	<b>P</b>	
Display Mode .....	16	Panic Alarms .....	17, 23
Duress Code .....	4	Partitioning .....	22
		PCS100 .....	18
<b>E</b>		PGMs .....	22
Erase Lost Remote Control .....	25	Programmable Outputs .....	22
Event Call Options .....	19	<b>Q</b>	
		Quick Function Keys .....	22
<b>F</b>		Quick Programming .....	24
Fire Alarms .....	17	<b>R</b>	
Fire Hazards .....	17	Re-arm Delay .....	13
Fire Safety .....	17		
Function .....	22		
<b>G</b>			
GSM Module Phone Number .....	20, 23		
<b>I</b>			
Icon Display .....	10		

Receiving Text Messages .....	18
Regular .....	14
Regular Arming .....	14
REM3 .....	25

## **S**

Sample Text Messages .....	19
Sending Text Messages to Arm/Disarm .....	19
Settings .....	2
Sleep Arming .....	14
SMS Event Call Options .....	19
Special Keys .....	22
Stay Arming .....	14
StayD .....	12
System Master Code .....	4
System Notes .....	22
System Options .....	24
System Timers .....	23

## **T**

Table of Contents .....	1
Test Report .....	25
Testing .....	18
Text .....	18
Time & Date .....	5
Time and Date .....	24
Timed Auto Arming .....	16
Trouble .....	6
Trouble Display .....	6

## **U**

User .....	24
User Codes .....	4
User Settings .....	2
Utility Keys .....	23

## **V**

VDMP3 .....	20
VDMP3 Instructions .....	21
Visual Feedback .....	7

## **W**

WARNINGS .....	0
Window Mode .....	13
WinLoad .....	24

## **Z**

Zone .....	22
Zone Setting .....	3
Zone Settings .....	3





The whole Paradox team wishes you a successful and easy installation. We hope this product performs to your complete satisfaction.

Should you have any questions or comments, please contact us.

For support, please contact your local distributor or contact Paradox at +1-450-491-7444

Monday to Friday, from 8:00 a.m. to 5:00 p.m. EST.

You may also e-mail us at [support@paradox.com](mailto:support@paradox.com).

Additional information can be found on our website [www.paradox.com/support](http://www.paradox.com/support)

**P ▲ R ▲ D O X™**