



Network Video Recorder

User's Manual

V4.3.2

Cybersecurity Recommendations

Mandatory actions to be taken towards cybersecurity

1. Change Passwords and Use Strong Passwords:

The number one reason systems get “hacked” is due to having weak or default passwords. It is recommended to change default passwords immediately and choose a strong password whenever possible. A strong password should be made up of at least 8 characters and a combination of special characters, numbers, and upper and lower case letters.

2. Update Firmware

As is standard procedure in the tech-industry, we recommend keeping NVR, DVR, and IP camera firmware up-to-date to ensure the system is current with the latest security patches and fixes.

“Nice to have” recommendations to improve your network security

1. Change Passwords Regularly

Regularly change the credentials to your devices to help ensure that only authorized users are able to access the system.

2. Change Default HTTP and TCP Ports:

- Change default HTTP and TCP ports for systems. These are the two ports used to communicate and to view video feeds remotely.
- These ports can be changed to any set of numbers between 1025-65535. Avoiding the default ports reduces the risk of outsiders being able to guess which ports you are using.

3. Enable HTTPS/SSL:

Set up an SSL Certificate to enable HTTPS. This will encrypt all communication between your devices and recorder.

4. Enable IP Filter:

Enabling your IP filter will prevent everyone, except those with specified IP addresses, from accessing the system.

5. Change ONVIF Password:

On older IP Camera firmware, the ONVIF password does not change when you change the system’s credentials. You will need to either update the camera’s firmware to the latest revision or manually change the ONVIF password.

6. Forward Only Ports You Need:

- Only forward the HTTP and TCP ports that you need to use. Do not forward a huge range of numbers to the device. Do not DMZ the device’s IP address.
- You do not need to forward any ports for individual cameras if they are all connected to a recorder on site; just the NVR is needed.

7. Disable Auto-Login on SmartPSS:

Those using SmartPSS to view their system and on a computer that is used by multiple people should disable auto-login. This adds a layer of security to prevent users without the appropriate credentials from accessing the system.

8. Use a Different Username and Password for SmartPSS:

In the event that your social media, bank, email, etc. account is compromised, you would not want someone collecting those passwords and trying them out on your video surveillance system. Using a different username and password for your security system will make it more difficult for someone to guess their way into your system.

9. Limit Features of Guest Accounts:

If your system is set up for multiple users, ensure that each user only has rights to features and functions they need to use to perform their job.

10. UPnP:

- UPnP will automatically try to forward ports in your router or modem. Normally this would be a good thing. However, if your system automatically forwards the ports and you leave the credentials defaulted, you may end up with unwanted visitors.
- If you manually forwarded the HTTP and TCP ports in your router/modem, this feature should be turned off regardless. Disabling UPnP is recommended when the function is not used in real applications.

11. SNMP:

Disable SNMP if you are not using it. If you are using SNMP, you should do so only temporarily, for tracing and testing purposes only.

12. Multicast:

Multicast is used to share video streams between two recorders. Currently there are no known issues involving Multicast, but if you are not using this feature, deactivation can enhance your network security.

13. Check the Log:

If you suspect that someone has gained unauthorized access to your system, you can check the system log. The system log will show you which IP addresses were used to login to your system and what was accessed.

14. Physically Lock Down the Device:

Ideally, you want to prevent any unauthorized physical access to your system. The best way to achieve this is to install the recorder in a lockbox, locking server rack, or in a room that is behind a lock and key.

15. Connect IP Cameras to the PoE Ports on the Back of an NVR:

Cameras connected to the PoE ports on the back of an NVR are isolated from the outside world and cannot be accessed directly.

16. Isolate NVR and IP Camera Network

The network your NVR and IP camera resides on should not be the same network as your public computer network. This will prevent any visitors or unwanted guests from getting access to the same network the security system needs in order to function properly.

Table of Contents

1	Features and Specifications	1
1.1	Overview.....	1
1.2	Features.....	1
1.3	Specifications.....	2
1.3.1	NVR21-S2/NVR21-P-S2/NVR21-8P-S2 Series.....	2
1.3.2	NVR1A-4P/1A-8P Series.....	5
1.3.3	NVR21HS-S2/21HS-P-S2/21HS-8P-S2 Series.....	7
1.3.4	NVR1AHS/1AHS-4P/1AHS-8P Series.....	9
1.3.5	NVR41HS-W-S2 Series.....	11
1.3.6	NVR41/41-P/41-8P/41-W Series	12
1.3.7	NVR41H/41H-P/41H-8P Series	14
1.3.8	NVR22-S2/22-P-S2/22-8P-S2 Series.....	16
1.3.9	NVR42N Series	18
1.3.10	NVR42/42-P/42-8P Series	19
1.3.11	NVR42-16P Series	21
1.3.12	NVR2A16 Series	23
1.3.13	NVR52-4KS2/52-8P-4KS2/52-16P-4KS2 Series	24
1.3.14	NVR44/44-8P/44-16P Series.....	26
1.3.15	NVR54-4KS2/54-16P-4KS2 Series	28
1.3.16	NVR58-4KS2/58-16P-4KS2 Series	30
1.3.17	NVR48/48-16P Series	31
1.3.18	NVR42V-8P Series	33
1.3.19	NVR41-4KS2/41-P-4KS2/41-8P-4KS2 Series.....	35
1.3.20	NVR41HS-4KS2/ 41HS-P-4KS2/41HS-8P-4KS2 Series	37
1.3.21	NVR42-4KS2/42-P-4KS2/42-8P-4KS2/42-16P-4KS2 Series.....	39
1.3.22	NVR5224-24P-4KS2 Series	42
1.3.23	NVR44-4KS2/44-16P-4KS2 Series	44
1.3.24	NVR5424-24P-4KS2 Series	46
1.3.25	NVR48-4KS2/48-16P-4KS2 Series	48
1.3.26	NVR21-4KS2/21-P-4KS2/21-8P-4KS2 Series.....	50
1.3.27	NVR21HS-4KS2/21HS-P-4KS2/21HS-8P-4KS2 Series	53
1.3.28	NVR22-4KS2/21-P-4KS2/22-8P-4KS2 Series.....	56
1.3.29	NVR52-16P-4KS2E Series	59
1.3.30	NVR54-16P-4KS2E Series	60
1.3.31	NVR58-16P-4KS2E Series	62
2	Front Panel and Rear Panel.....	65
2.1	Front Panel.....	65
2.1.1	NVR41/41-P/41-W/21-S2/21-P-S2/21-8P-S2/41-4KS2/41-P-4KS2/41-8P-4KS2/1A-4P/1A-8P/21-4KS2/21-P-4KS2/21-8P-4KS2 Series	65
2.1.2	NVR41H/41H-P/41H-8P Series	65
2.1.3	NVR41HS-W-S2 Series.....	66
2.1.4	NVR41-8P Series	67

2.1.5	NVR42/42-P/42-8P Series	67
2.1.6	NVR21HS-S2/21HS-P-S2/21HS-8P-S2/41HS-4KS2/41HS-P-4KS2/41HS-8P-4KS2/1AHS/1AHS-4P/1AHS-8P/21HS-4KS2/21HS-P-4KS2/21HS-8P-4KS2 Series	69
2.1.7	NVR/22-S2/22-P-S2/22-8P-S2/42-16P/42N/52-4KS2/52-8P-4KS2/52-16P-4KS2/42-4KS2/42-P-4KS2/42-8P-4KS2/42-16P-4KS2/5224-24P-4KS2/54-4KS2/54-16P-4KS2/44-4KS2/44-16P-4KS2/5424-24P-4KS2/58-4KS2/S258-16P-4KS2/48-4KS2/48-16P-4KS2/2A16/22-4KS2-22-P-4KS2-22-8P-4KS2/52-16P-4KS2E/54-16P-4KS2E/58-16P-4KS2E Series	69
2.1.8	NVR44/44-8P/44-16P Series.....	70
2.1.9	NVR48/48-16P Series	72
2.1.10	NVR42V-8P Series.....	75
2.2	Rear Panel	76
2.2.1	NVR41/41-P/41-8P/41-W Series	76
2.2.2	NVR21-S2/21-P-S2/21-8P-S2/1A-4P/1A-8P/21-4KS2/21-P-4KS2/21-8P-4KS2 Series	78
2.2.3	NVR41H/41H-P/41H-8P Series.....	79
2.2.4	NVR21HS-S2/21HS-P-S2/21HS-8P-S2/1AHS/1AHS-4P/1AHS-8P/21HS-4KS2/21HS-P-4KS2/21HS-8P-4KS2 Series.....	80
2.2.5	NVR41HS-W-S2 Series.....	82
2.2.6	NVR22-S2/22-P-S2/22-8P-S2/2A16/22-4KS2/22-P-4KS2/22-8P-4KS2 Series	83
2.2.7	NVR42/42N/42-P/42-8P/42-16P Series.....	84
2.2.8	NVR52-4KS2/52-8P-4KS2/52-16P-4KS2/5224-24P-4KS2/52-16P-4KS2E Series	86
2.2.9	NVR44/44-8P/44-16P Series.....	89
2.2.10	NVR54-4KS2/58-4KS2/54-16P-4KS2/58-16P-4KS2/5424-24P-4KS2/5816P-4KS2E Series	91
2.2.11	NVR48/48-16P Series	94
2.2.12	NVR42V-8P Series.....	96
2.2.13	NVR41-4KS2/41-P-4KS2/41-8P-4KS2	97
2.2.14	NVR41HS-4KS2/41HS-P-4KS2/41HS-8P-4KS2.....	99
2.2.15	NVR42-4KS2/42-P-4KS2/42-8P-4KS2/42-16P-4KS2	100
2.2.16	NVR44-4KS2/44-16P-4KS2.....	102
2.2.17	NVR48-4KS2/48-16P-4KS2 Series	104
2.3	Alarm Connection.....	106
2.3.1	Alarm Port.....	106
2.3.2	Alarm input port	107
2.3.3	Alarm input and output port.....	108
2.3.4	Alarm relay specifications	108
2.4	Bidirectional talk	108
2.4.1	Device-end to PC-end	108
2.4.2	PC-end to the device-end	109
2.5	Mouse Operation.....	109
2.6	Remote Control	110
3	Device Installation	113
3.1	Device Installation Diagrams.....	113

3.2	Check Unpacked NVR.....	113
3.3	About Front Panel and Rear Panel.....	113
3.4	HDD Installation.....	114
3.4.1	NVR41/41-P/41-8P/41-W/21-S2/21-P-S2/21-8P-S2/41-4KS2/41-P-4KS2/41-8P-4KS2/1A-4P/1A-8P/21-4KS2/21-P-4KS2/21-8P-4KS2 Series	114
3.4.2	NVR41H/41H-P/41H-8P/21HS-S2/21HS-P-S2/21HS-8P-S2/41HS-W-S2/41HS-4KS2/41HS-P-4KS2/41HS-8P-4KS2/1AHS/1AHS-4P/1AHS-8P/21HS-4KS2/21HS-P-4KS2/21HS-8P-4KS2 Series	115
3.4.3	NVR42/42N/42-P/42-8P/42-16P/42-4K/42-8P-4K/52-4KS2/52-8P-4KS2/52-16P-4KS2/22-S2/22-P-S2/22-8P-S2/42-4KS2/42-P-4KS2/42-8P-4KS2/42-16P-4KS2/5224-24P-4KS2/2A16/22-4KS2/22-P-4KS2/22-8P-4KS2/52-16P-4KS2E Series.....	115
3.4.4	NVR44/44-8P/44-16P/54-4KS2/54-16P-4KS2/44-4KS2/44-16P-4KS2/5424-24P-4KS2/54-16P-4KS2E Series	116
3.4.5	NVR48/48-16P/58-4KS2/58-16P-4KS2/48-4KS2/48-16P-4KS2/52-16P-4KS2E Series.....	116
3.4.6	NVR42V-8P Series	117
3.5	CD-ROM Installation.....	118
3.6	Connection Sample.....	119
3.6.1	NVR41/41-P/41-8P/41-W/21-S2/21-P-S2/21-8P-S2/41-4KS2/41-P-4KS2/41-8P-4KS2/1A-4P/1A-8P/21-4KS2/21-P-4KS2/21-8P-4KS2 Series	119
3.6.2	NVR41H/41H-P/41H-8P Series	120
3.6.3	NVR41HS-W-S2 Series.....	121
3.6.4	NVR21HS-S2/21HS-P-S2/21HS-8P-S2/41HS-4KS2/41HS-P-4KS2/41HS-8P-4KS2/1AHS/1AHS-4P/1AHS-8P/21HS-4KS2/21HS-P-4KS2/21HS-8P-4KS2 Series	122
3.6.5	NVR22-S2/22-P-S2/22-8P-S2/2A16/22-4KS2/22-P-4KS2/22-8P-4KS2 Series	123
3.6.6	NVR42N Series	124
3.6.7	NVR42/42-P/42-8P/42-16P/52-4KS2/52-8P-4KS2/52-16P-4KS2/5224-24P-4KS2/52-16P-4KS2E Series.....	125
3.6.8	NVR42-8P-4K/42-4KS2/42-P-4KS2/42-8P-4KS2/42-16P-4KS2 Series.....	125
3.6.9	NVR54-4KS2/54-16P-4KS2/58-4KS2/58-16P-4KS2/5424-24P-4KS2/54-16P-4KS2E/5816P-4KS2E Series	126
3.6.10	NVR44/44-8P/44-16P/44-4KS2/44-16P-4KS2 Series	127
3.6.11	NVR48/48-16P/48-4KS2/48-16P-4KS2 Series.....	127
3.6.12	NVR42V-8P Series	128
4	Local Basic Operation	130
4.1	Getting Started.....	130
4.1.1	Boot up and Shut down	130
4.1.2	Device Initialization	130
4.1.3	Reset Password.....	134

4.1.4	Quick Settings.....	137
4.2	Camera	162
4.2.1	Connection	162
4.2.2	Remote Device Initialization	165
4.2.3	Short-Cut Menu to Register Camera.....	170
4.2.4	Image	170
4.2.5	Encode.....	172
4.2.6	Channel Name.....	176
4.2.7	Remote Upgrade	177
4.2.8	Remote Device Info.....	178
4.3	Preview	180
4.3.1	Preview	180
4.3.2	Navigation bar.....	180
4.3.3	Preview Control Interface.....	183
4.3.4	Right Click Menu	185
4.3.5	Edit View (Sequence)	187
4.3.6	Preview Display Effect Setup	189
4.3.7	Fisheye (Optional).....	196
4.4	PTZ.....	198
4.4.1	PTZ Settings.....	198
4.4.2	PTZ Control	200
4.5	Record File	205
4.6	Playback and Search.....	205
4.6.1	Instant Playback	205
4.6.2	Search Interface	205
4.6.3	Smart Search Playback.....	213
4.6.4	Mark Playback	214
4.6.5	Playback Image	215
4.6.6	Splice Playback.....	215
4.6.7	Smart Playback.....	216
4.6.8	File List.....	221
4.6.9	Other Aux Functions	223
4.7	Event Manager	223
4.7.1	Video Detect.....	223
4.7.2	Smart Plan.....	230
4.7.3	IVS (General Behavior Analytics) (Optional)	232
4.7.4	Face Detect (Optional).....	251
4.7.5	People Counting (Optional).....	252
4.7.6	Heat Map	253
4.7.7	Plate Recognition	255
4.7.8	Audio Detect (Optional)	257
4.7.9	Alarm Settings.....	258
4.7.10	Abnormality.....	263
4.7.11	Alarm output	265
4.7.12	POS	266
4.8	Network.....	270

4.8.1	Network Settings	270
4.8.2	Network Test.....	289
4.9	Storage	291
4.9.1	Basic.....	291
4.9.2	Schedule.....	292
4.9.3	HDD.....	292
4.9.4	FTP.....	293
4.9.5	Record Control.....	294
4.9.6	HDD Information.....	295
4.9.7	HDD Group.....	297
4.9.8	HDD Detect	297
4.9.9	RAID Manager	300
4.10	Device Maintenance and Manager.....	302
4.10.1	Account	302
4.10.2	System Info.....	311
4.10.3	Voice.....	314
4.10.4	RS232	316
4.10.5	Broadcast.....	317
4.10.6	Security	319
4.10.7	Auto Maintain	321
4.10.8	Backup	321
4.10.9	Default.....	325
4.10.10	Upgrade.....	326
4.11	Logout /Shutdown/Restart	328
5	Web Operation.....	329
5.1	General Introduction	329
5.1.1	Preparation.....	329
5.2	Device Initialization	329
5.2.1	Log in.....	332
5.3	Reset Password	333
5.4	LAN Mode.....	334
5.5	Real-time Monitor	336
5.6	PTZ.....	337
5.7	Image/Alarm-out.....	338
5.7.1	Image	339
5.7.2	Alarm output.....	339
5.8	Zero-channel Encode	339
5.9	WAN Login	340
5.10	Setup.....	341
5.10.1	Camera	341
5.10.2	Network.....	353
5.10.3	Event	371
5.10.4	Storage.....	399
5.10.5	Setting.....	407
5.11	Information	429
5.11.1	Version	429









5.11.2	Log.....	429
5.11.3	Online User.....	430
5.11.4	People Counting.....	431
5.11.5	Heat Map.....	431
5.11.6	HDD.....	432
5.12	Playback.....	432
5.12.1	Search Record.....	433
5.12.2	File List.....	433
5.12.3	Playback.....	434
5.12.4	Download.....	434
5.12.5	Load more.....	435
5.13	Smart Playback.....	437
5.13.1	IVS (Behavior Analytics).....	438
5.13.2	Plate recognition.....	439
5.13.3	Human Face.....	440
5.14	Alarm.....	441
5.15	Log out.....	442
5.16	Un-install Web Control.....	443
6	Glossary.....	444
7	FAQ.....	445
8	Appendix A HDD Capacity Calculation.....	450
9	Appendix B Compatible Network Camera List.....	451

General

This user's manual (hereinafter referred to be "the Manual") introduces the functions and operations of the Network Video Recorder (NVR) devices (hereinafter referred to be "the Device").

Safety Instructions

The following categorized signal words with defined meaning might appear in the Manual.

Signal Words	Meaning
 DANGER	Indicates a high potential hazard which, if not avoided, will result in death or serious injury.
 WARNING	Indicates a medium or low potential hazard which, if not avoided, could result in slight or moderate injury.
 CAUTION	Indicates a potential risk which, if not avoided, could result in property damage, data loss, lower performance, or unpredictable result.
 ELECTRICITY	Indicates dangerous high voltage. Take care to avoid coming into contact with electricity.
 LASER BEAM	Indicates a laser radiation hazard. Take care to avoid exposure to a laser beam.
 ESD	Electrostatic Sensitive Devices. Indicates a device that is sensitive to electrostatic discharge.
 TIPS	Provides methods to help you solve a problem or save you time.
 NOTE	Provides additional information as the emphasis and supplement to the text.

Privacy Protection Notice

As the device user or data controller, you might collect personal data of others' such as face, fingerprints, car plate number, Email address, phone number, GPS and so on. You need to be in compliance with the local privacy protection laws and regulations to protect the legitimate rights and interests of other people by implementing measures include but not limited to: providing clear and visible identification to inform data subject the existence of surveillance area and providing related contact.

About the Manual

- The Manual is for reference only. If there is inconsistency between the Manual and the actual product, the actual product shall govern.
- We are not liable for any loss caused by the operations that do not comply with the Manual.
- The Manual would be updated according to the latest laws and regulations of related regions. For detailed information, see the paper User's Manual, CD-ROM, QR code or our official website. If there is inconsistency between paper User's Manual and the electronic version, the electronic version shall prevail.
- All the designs and software are subject to change without prior written notice. The product updates might cause some differences between the actual product and the Manual. Please contact the customer service for the latest program and supplementary documentation.
- There still might be deviation in technical data, functions and operations description, or errors in print. If there is any doubt or dispute, please refer to our final explanation.
- Upgrade the reader software or try other mainstream reader software if the Manual (in PDF format) cannot be opened.
- All trademarks, registered trademarks and the company names in the Manual are the properties of their respective owners.
- Please visit our website, contact the supplier or customer service if there is any problem occurred when using the device.
- If there is any uncertainty or controversy, please refer to our final explanation

Important Safeguards and Warnings

The following description is the correct application method of the device. Read the manual carefully before use to prevent danger and property loss. Strictly conform to the manual during application and keep it properly after reading.

Operating Requirement

- Don't place and install the device in an area exposed to direct sunlight or near heat generating device.
- Don't install the device in a humid, dusty or fuliginous area.
- Keep its horizontal installation, or install it at stable places, and prevent it from falling.
- Don't drip or splash liquids onto the device; don't put on the device anything filled with liquids, in order to prevent liquids from flowing into the device.
- Install the device at well-ventilated places; don't block its ventilation opening.
- Use the device only within rated input and output range.
- Don't dismantle the device arbitrarily.
- Transport, use and store the device within allowed humidity and temperature range.

Power Requirement

- Make sure to use batteries according to requirements; otherwise, it may result in fire, explosion or burning risks of batteries!
- To replace batteries, only the same type of batteries can be used.
- The product shall use electric wires (power wires) recommended by this area, which shall be used within its rated specification.
- Make sure to use standard power adapter matched with this device. Otherwise, the user shall undertake resulting personnel injuries or device damages.
- Use power supply that meets SELV (safety extra low voltage) requirements, and supply power with rated voltage that conforms to Limited Power Source in IEC60950-1. For specific power supply requirements, please refer to device labels.
- Products with category I structure shall be connected to grid power output socket, which is equipped with protective grounding.
- Appliance coupler is a disconnecting device. During normal use, please keep an angle that facilitates operation.

1 Features and Specifications

1.1 Overview

This series NVR is a high performance network video recorder. This series product support local preview, multiple-window display, recorded file local storage, remote control and mouse shortcut menu operation, and remote management and control function.

This series product supports center storage, front-end storage and client-end storage. The monitor zone in the front-end can be set in anywhere. Working with other front-end devices such as IPC, NVS, this series product can establish a strong surveillance network via the CMS. In the network system, there is only one network cable from the monitor center to the monitor zone in the whole network. There is no audio/video cable from the monitor center to the monitor zone. The whole project is featuring of simple connection, low-cost, low maintenance work.

This series NVR can be widely used in many areas such as public security, water conservancy, transportation and education.

1.2 Features

Cloud Upgrade	<ul style="list-style-type: none">• For the NVR connected with the Internet, it supports online upgrade to update applications.
Real-time Surveillance	<ul style="list-style-type: none">• VGA, HDMI port. Connect to monitor to realize real-time surveillance. Some series support TV/VGA/HDMI output at the same time.• Short-cut menu when preview.• Support popular PTZ decoder control protocols. Support preset, tour and pattern.
Playback	<ul style="list-style-type: none">• Support each channel real-time record independently, and at the same time it can support search, forward play, network monitor, record search, download and etc.• Support various playback modes: slow play, fast play, backward play and frame by frame play.• Support time title overlay so that you can view event accurate occurred time• Support specified zone enlargement.
User Management	<ul style="list-style-type: none">• Each group has different management powers that can be edited freely. Every user belongs to an exclusive group.
Storage	<ul style="list-style-type: none">• Via corresponding setup (such as alarm setup and schedule setup), you can backup related audio/video data in the network video recorder.• Support Web record and record local video and storage the file in the client end.
Alarm	<ul style="list-style-type: none">• Respond to external alarm simultaneously (within 200MS), based on user's pre-defined relay setup, system can process the alarm input correctly and prompt user by screen and voice (support pre-recorded audio).• Support central alarm server setup, so that alarm information can remotely notify user automatically. Alarm input can be derived from

	<p>various connected peripheral devices.</p> <ul style="list-style-type: none"> Alert you via email/sms.
Network Monitor	<ul style="list-style-type: none"> Through network, sending audio/video data compressed by IPC or NVS to client-ends, then the data will be decompressed and display. Support max 128 connections at the same time. Transmit audio/video data by HTTP, TCP, UDP, MULTICAST, RTP/RTCP and etc. Transmit some alarm data or alarm info by SNMP. Support WEB access in WAN/LAN.
Window Split	<ul style="list-style-type: none"> Adopt the video compression and digital process to show several windows in one monitor. Support 1/4/8/9/16/ 25/36-window display when preview and 1/4/9/16-window display when playback.
Record	<ul style="list-style-type: none"> Support normal/motion detect/alarm record function. Save the recorded files in the HDD, USB device, client-end PC, or network storage server. You can search or playback the saved files at the local-end or via the Web/USB device.
Backup	<ul style="list-style-type: none"> Support network backup, USB2.0 record backup function, the recorded files can be saved in network storage server, peripheral USB2.0 device, burner and etc.
Network Management	<ul style="list-style-type: none"> Supervise NVR configuration and control power via Ethernet. Support management via WEB.
Peripheral Equipment Management	<ul style="list-style-type: none"> Support peripheral equipment management such as protocol setup and port connection. Support transparent data transmission such as RS232 (RS-422), RS485 (RS-485).
Auxiliary	<ul style="list-style-type: none"> Support switch between NTSC and PAL. Support real-time system resources information and running statistics display. Support log file. Local GUI output. Shortcut menu operation via mouse. IR control function (For some series product only.). Shortcut menu operation via remote control. Play the video/audio from the network camera or NVS remotely.

1.3 Specifications

1.3.1 NVR21-S2/NVR21-P-S2/NVR21-8P-S2 Series

Model		21-S2 Series	21-P-S2 Series	21-8P-S2 Series
System	System Resources	4/8/16-ch series product support 4/8/16 HD connection respectively. Total bandwidth supports 80Mbps.	4/8-ch series product support 4/8 HD connection respectively. Total bandwidth supports 80Mbps.	
	OS	Embedded Linux real-time operation system		

Model		21-S2 Series	21-P-S2 Series	21-8P-S2 Series
	Operation Interface	WEB/Local GUI		
Decode	Video Decode Type	H.264		
	Decode Capability	Max 4-ch 1080P 30fps or 8-ch 720P 30fps or 8-ch D1 30fps		
Video	Video Input	4/8/16-ch network compression video input	4/8-ch network compression video input	
	Video Output	1-channel VGA analog video output		
	HDMI	1-ch HDMI output. Version number is 1.4		
	Window Split	1/4/8/9/16-window	1/4/8/9-window	
Audio	Audio Input	1-ch bidirectional talk input		
	Audio Output	1-ch bidirectional talk output		
	Audio Compression Standard	G.711a		
Alarm	Alarm Input	N/A		
	Alarm Output	N/A		
Function	Storage	1 built-in SATA port		
	Multiple-Channel Playback	Max 8-channel D1 or 8-channel 720P or 4-channel 1080P playback		

Model		21-S2 Series	21-P-S2 Series	21-8P-S2 Series
Port and Indicator	RS232 Port	N/A		
	RS485 Port	N/A		
	USB Port	2 peripheral USB2.0 ports.		
	Network Connection	1 RJ45 10/100Mbps self-adaptive Ethernet port.		
	PoE	N/A	4	8
	Power Port	1 power socket. Power adapter power supplying mode. DC 12V power.	1 power socket. Power adapter power supplying mode. DC 48V power.	1 power socket. Power adapter power supplying mode. DC 48V power.
	Power Button	N/A		
	Power On-off Button	N/A		
	IR Receiver Window	N/A		
	Clock	Built-in clock.		
	Indicator Light	One power status indicator light. One network status indicator light. One HDD status indicator light.		
General	Power Consumption	<10W (No HDD)		
	Working Temperature	- 10°C ~ + 55°C		
	Working Humidity	10%~90%		
	Air pressure	86kPa~106kPa		
	Dimension	205mm×206.75mm×	205mm×206.75mm×	425mm×95mm×260

Model		21-S2 Series	21-P-S2 Series	21-8P-S2 Series
		45.2mm	45.2mm	mm
	Weight	0.5kg~2kg (No HDD)		
	Installation Mode	Desk installation		

1.3.2 NVR1A-4P/1A-8P Series

Model		NVR1A-4P Series	NVR1A-8P Series
System	System Resources	4/8-ch series product support 4/8 HD connection respectively. Total bandwidth supports 80Mbps.	
	OS	Embedded Linux real-time operation system	
	Operation Interface	WEB/Local GUI	
Decode	Video Decode Type	Smart H.264+/H.264	
	Decode Capability	Max 4-ch 1080P 30fps or 8-ch 720P 30fps or 8-ch D1 30fps	
Video	Video Input	4/8-ch network compression video input	
	Video Output	1-channel VGA analog video output	
	HDMI	1-ch HDMI output. Version number is 1.4	
	Window Split	1/4/8/9-window	
Audio	Audio Input	1-ch bidirectional talk input	
	Audio Output	1-ch bidirectional talk output	

Model		NVR1A-4P Series	NVR1A-8P Series
	Audio Compression Standard	G.711a	
Alarm	Alarm Input	N/A	
	Alarm Output	N/A	
Function	Storage	1 built-in SATA port	
	Multiple-Channel Playback	Max 8-channel D1 or 8-channel 720P or 4-channel 1080P playback	
Port and Indicator	RS232 Port	N/A	
	RS485 Port	N/A	
	USB Port	2 peripheral USB2.0 ports.	
	Network Connection	1 RJ45 10/100Mbps self-adaptive Ethernet port.	
	PoE	4	8
	Power Port	1 power socket. Power adapter power supplying mode. DC 48V power.	1 power socket. Power adapter power supplying mode. DC 48V power.
	Power Button	N/A	
	Power On-off Button	N/A	
	IR Receiver Window	N/A	
	Clock	Built-in clock.	

Model		NVR1A-4P Series	NVR1A-8P Series
	Indicator Light	One power status indicator light. One network status indicator light. One HDD status indicator light.	
General	Power Consumption	<10W (No HDD)	
	Working Temperature	- 10°C ~ + 55°C	
	Working Humidity	10%~90%	
	Air pressure	86kPa~106kPa	
	Dimension	205mm×206.75mm×45.2mm	425mm×95mm×260mm
	Weight	0.5kg~2kg (No HDD)	
	Installation Mode	Desk installation	

1.3.3 NVR21HS-S2/21HS-P-S2/21HS-8P-S2 Series

Model		NVR21HS-S2 Series	NVR21HS-P-S2 Series	NVR21HS-8P-S2 Series
System	System Resources	4/8/16-ch series product support 4/8/16 HD connection respectively. Total bandwidth supports 80Mbps.	4/8-ch series product support 4/8 HD connection respectively. Total bandwidth supports 80Mbps.	
	OS	Embedded Linux real-time operation system		
	Operation Interface	WEB/Local GUI		
Decode	Video Decode Type	H.264		
	Decode Capability	Max 4-ch 1080P 30fps or 8-ch 720P 30fs or 8-ch D1 30fps		
Video	Video Input	4/8/16-ch network compression video input	4/8-ch network compression video input	

Model		NVR21HS-S2 Series	NVR21HS-P-S2 Series	NVR21HS-8P-S2 Series
	Video Output	1-channel VGA analog video output		
	HDMI	1-ch HDMI output. Version number is 1.4		
	Window Split	1/4/8/9/16-window	1/4/8/9-window	
Audio	Audio Input	1-ch bidirectional talk input		
	Audio Output	1-ch bidirectional talk output		
	Audio Compression Standard	G.711a		
Alarm	Alarm Input	N/A		
	Alarm Output	N/A		
Function	Storage	1 built-in SATA port		
	Multiple-Channel Playback	Max 4-channel 1080P or 8-channel 720P or 8-channel D1 playback		
Port and Indicator	RS232 Port	N/A		
	RS485 Port	N/A		
	USB Port	2 peripheral USB2.0 ports.		
	Network Connection	1 RJ45 10/100Mbps self-adaptive Ethernet port.		
	PoE Port	N/A	4	8
	Power Port	1 power socket. Power adapter power supplying mode. DC 12V power.	1 power socket. Power adapter power supplying mode. DC 48V power.	1 power socket. Power adapter power supplying mode. DC 48V power.
	Power Button	N/A		
	Power On-off Button	N/A		
	IR Receiver Window	N/A		
	Clock	Built-in clock.		
	Indicator Light	One power status indicator light. One network status indicator light.		

Model		NVR21HS-S2 Series	NVR21HS-P-S2 Series	NVR21HS-8P-S2 Series
		One HDD status indicator light.		
General	Power Consumption	<10W (No HDD)		
	Working Temperature	- 10°C ~ + 55°C		
	Working Humidity	10%~90%		
	Air pressure	86kPa~106kPa		
	Dimension(W×D×H)	260mm×220mm×44mm		
	Weight	0.7kg~0.8kg (No HDD)		
	Installation Mode	Desk installation		

1.3.4 NVR1AHS/1AHS-4P/1AHS-8P Series

Model		NVR1AHS Series	NVR1AHS-4P Series	NVR1AHS-8P Series
System	System Resources	4/8-ch series product support 4/8 HD connection respectively. Total bandwidth supports 80Mbps.	4/8-ch series product support 4/8 HD connection respectively. Total bandwidth supports 80Mbps.	
	OS	Embedded Linux real-time operation system		
	Operation Interface	WEB/Local GUI		
Decode	Video Decode Type	Smart H.264+/H.264		
	Decode Capability	Max 4-ch 1080P 30fps or 8-ch 720P 30fs or 8-ch D1 30fps		
Video	Video Input	4/8-ch network compression video input	4/8-ch network compression video input	
	Video Output	1-channel VGA analog video output		
	HDMI	1-ch HDMI output. Version number is 1.4		
	Window Split	1/4/8/9-window	1/4/8/9-window	

Model		NVR1AHS Series	NVR1AHS-4P Series	NVR1AHS-8P Series
Audio	Audio Input	1-ch bidirectional talk input		
	Audio Output	1-ch bidirectional talk output		
	Audio Compression Standard	G.711a		
Alarm	Alarm Input	N/A		
	Alarm Output	N/A		
Function	Storage	1 built-in SATA port		
	Multiple-Channel Playback	Max 4-channel 1080P or 8-channel 720P or 8-channel D1 playback		
Port and Indicator	RS232 Port	N/A		
	RS485 Port	N/A		
	USB Port	2 peripheral USB2.0 ports.		
	Network Connection	1 RJ45 10/100Mbps self-adaptive Ethernet port.		
	PoE Port	N/A	4	8
	Power Port	1 power socket. Power adapter power supplying mode. DC 12V power.	1 power socket. Power adapter power supplying mode. DC 48V power.	1 power socket. Power adapter power supplying mode. DC 48V power.
	Power Button	N/A		
	Power On-off Button	N/A		
	IR Receiver Window	N/A		
	Clock	Built-in clock.		
	Indicator Light	One power status indicator light. One network status indicator light. One HDD status indicator light.		
General	Power Consumption	<10W (No HDD)		
	Working Temperature	- 10°C ~ + 55°C		

Model		NVR1AHS Series	NVR1AHS-4P Series	NVR1AHS-8P Series
	Working Humidity	10%~90%		
	Air pressure	86kPa~106kPa		
	Dimension(W×D×H)	260mm×220mm×44mm		
	Weight	0.7kg~0.8kg (No HDD)		
	Installation Mode	Desk installation		

1.3.5 NVR41HS-W-S2 Series

Model		41HS-W-S2 Series
System	System Resources	4/8-ch series product support 4/8 HD connection respectively. Total bandwidth supports 80Mbps.
	OS	Embedded Linux real-time operation system
	Operation Interface	WEB/Local GUI
Decode	Video Decode Type	H.264/MJPEG/MPEG4
	Decode Capability	Max 8-ch 1080P or 4-ch 3M or 2-ch 5M.
Video	Video Input	4/8-ch network compression video input
	Video Output	1-channel VGA analog video output
	HDMI	1-ch HDMI output. Version number is 1.4
	Window Split	1/4/8/9-window
Audio	Audio Input	N/A
	Audio Output	N/A
	Audio Compression Standard	G.711a
Alarm	Alarm Input	N/A
	Alarm Output	N/A
Function	Storage	1 built-in SATA port

Model		41HS-W-S2 Series
	Multiple-Channel Playback	Max 8-ch 1080P playback
Port and Indicator	RS232 Port	N/A
	RS485 Port	N/A
	USB Port	2 peripheral USB2.0 ports. One at the front panel and one at the rear panel.
	Network Connection	1 RJ45 10/100Mbps self-adaptive Ethernet port.
	PoE Port	N/A
	Power Port	1 power socket. Power adapter power supplying mode. DC 12V/2A power.
	Power Button	N/A
	Power On-off Button	N/A
	IR Receiver Window	N/A
	Clock	Built-in clock.
	Indicator Light	One power status indicator light. One network status indicator light. One HDD status indicator light.
General	Power Consumption	<30W (No HDD)
	Working Temperature	- 10°C ~ + 55°C
	Working Humidity	10%~90%
	Air pressure	86kPa~106kPa
	Dimension(W*D*H)	375mm×287mm×52mm
	Weight	1.5kg~2.5kg(No HDD)
	Installation Mode	Desk installation

1.3.6 NVR41/41-P/41-8P/41-W Series

Model		41 Series	41-P Series	41-8P Series	41-W Series
System	System Resources	4/8/16-ch series product support 4/8/16 HD connection respectively. Total bandwidth supports 28/56/80Mbps respectively.			
	OS	Embedded Linux real-time operation system			

Model		41 Series	41-P Series	41-8P Series	41-W Series
	Operation Interface	WEB/Local GUI			
Decode	Video Decode Type	H.264/MJPEG/MJPEG4			
	Decode Capability	Max 2-ch 5M 25fps or 4-ch 3M 25fps or 4-ch 1080P 30fps or 8-ch 720P 30fs			
Video	Video Input	4/8/16-ch network compression video input			
	Video Output	1-channel VGA analog video output			
	HDMI	1-ch HDMI output. Version number is 1.4			
	Window Split	1/4/8/9/16-window			1/4-window
Audio	Audio Input	1-ch bidirectional talk input			
	Audio Output	1-ch bidirectional talk output			
	Audio Compression Standard	G.711a			
Alarm	Alarm Input	N/A			
	Alarm Output	N/A			
Function	Storage	1 built-in SATA port			
	Multiple-Channel Playback	Max 4-channel 1080P playback			
	WIFI AP	N/A			Yes
Port and Indicator	RS232 Port	N/A			
	RS485 Port	N/A			
	USB Port	2 peripheral USB2.0 ports.			
	Network Connection	1 RJ45 10/100Mbps self-adaptive Ethernet port.			
	PoE Port	N/A	4	8	N/A
	Power Port	1 power socket. Power adapter power supplying mode. DC 12V power.	1 power socket. Power adapter power supplying mode. DC 48V power.		1 power socket. Power adapter power supplying mode. DC 12V power.

Model		41 Series	41-P Series	41-8P Series	41-W Series
	Power Button	1 button			
	Power On-off Button	N/A			
	IR Receiver Window	N/A			
	Clock	Built-in clock.			
	Indicator Light	One power status indicator light. One network status indicator light. One HDD status indicator light.			
General	Power Consumption	<10W (No HDD)			
	Working Temperature	- 10°C ~ + 55°C			
	Working Humidity	10%~90%			
	Air pressure	86kPa~106kPa			
	Dimension	205mm×206.75mm×45.2mm	270mm×204mm×42mm	205mm×206.75mm×45.2mm	
	Weight	0.5kg~1kg (No HDD)			
	Installation Mode	Desk installation			

1.3.7 NVR41H/41H-P/41H-8P Series

Model		41H Series	41H-P Series	41H-8P Series
System	System Resources	4/8/16-ch series product support 4/8/16 HD connection respectively. Total bandwidth supports 28/56/80Mbps respectively.		
	OS	Embedded Linux real-time operation system		
	Operation Interface	WEB/Local GUI		
Decode	Video Decode Type	H.264/MJPEG/MJPEG4		
	Decode Capability	Max 2-ch 5M 25fps or 4-ch 3M 25fps or 4-ch 1080P 30fps or 8-ch 720P 30fs		
Video	Video Input	4/8/16-ch network compression video input		
	Video Output	1-channel VGA analog video output		
	HDMI	1-ch HDMI output. Version number is 1.4		
	Window Split	1/4/8/9/16-window		

Model		41H Series	41H-P Series	41H-8P Series
Audio	Audio Input	1-ch bidirectional talk input		
	Audio Output	1-ch bidirectional talk output		
	Audio Compression Standard	G.711a		
Alarm	Alarm Input	N/A		2-channel
	Alarm Output	N/A		2-channel
Function	Storage	1 built-in SATA port		
	Multiple-Channel Playback	Max 4-channel 1080P playback		
Port and Indicator	RS232 Port	N/A		
	RS485 Port	N/A		
	USB Port	2 peripheral USB2.0 ports.		
	Network Connection	1 RJ45 10/100Mbps self-adaptive Ethernet port.		
	PoE Port	N/A	4	8
	Power Port	1 power socket. Power adapter power supplying mode. DC 12V power.	1 power socket. Power adapter power supplying mode. DC 48V power.	
	Power Button	1 button		
	Power On-off Button	N/A		
	IR Receiver Window	N/A		
	Clock	Built-in clock.		
	Indicator Light	One power status indicator light. One network status indicator light. One HDD status indicator light.		
General	Power Consumption	<10W (No HDD)		
	Working Temperature	- 10°C ~ + 55°C		
	Working Humidity	10%~90%		

Model		41H Series	41H-P Series	41H-8P Series
	Air pressure	86kPa~106kPa		
	Dimension	325mm×250.58mm×51mm		
	Weight	0.5kg~1kg (No HDD)		
	Installation Mode	Desk installation		

1.3.8 NVR22-S2/22-P-S2/22-8P-S2 Series

Model		NVR22-S2 Series	NVR22-P-S2 Series	NVR22-8P-S2 Series
System	System Resources	4/8/16-ch series product support 4/8/16 HD connection respectively. Total bandwidth supports 80Mbps.	4/8-ch series product support 4/8 HD connection respectively. Total bandwidth supports 80Mbps.	
	OS	Embedded Linux real-time operation system		
	Operation Interface	WEB/Local GUI		
Decode	Video Decode Type	H.264		
	Decode Capability	Max 4-ch 1080P 30fps or 8-ch 720P 30fs or 8-ch D1 30fps		
Video	Video Input	4/8/16-ch network compression video input	4/8-ch network compression video input	
	Video Output	1-channel VGA analog video output		
	HDMI	1-ch HDMI output. Version number is 1.4		
	Window Split	1/4/8/9/16-window	1/4/8/9-window	
Audio	Audio Input	1-ch bidirectional talk input		
	Audio Output	1-ch bidirectional talk output		
	Audio Compression Standard	G.711a		
Alarm	Alarm Input	N/A		

Model		NVR22-S2 Series	NVR22-P-S2 Series	NVR22-8P-S2 Series
	Alarm Output	N/A		
Function	Storage	2 built-in SATA ports		
	Multiple-Channel Playback	Max 4-channel 1080P or 8-channel 720P or 8-channel D1 playback		
Port and Indicator	RS232 Port	N/A		
	RS485 Port	N/A		
	USB Port	2 peripheral USB2.0 ports.		
	Network Connection	1 RJ45 10/100Mbps self-adaptive Ethernet port.		
	PoE Port	N/A	4	8
	Power Port	1 power socket. Power adapter power supplying mode. DC 12V power.	1 power socket. Power adapter power supplying mode. DC 48V power.	1 power socket. Power adapter power supplying mode. DC 48V power.
	Power Button	N/A		
	Power On-off Button	N/A		
	IR Receiver Window	N/A		
	Clock	Built-in clock.		
	Indicator Light	One power status indicator light. One network status indicator light. One HDD status indicator light.		
General	Power Consumption	<10W (No HDD)		
	Working Temperature	- 10°C ~ + 55°C		
	Working Humidity	10%~90%		
	Air pressure	86kPa~106kPa		
	Dimension(W×D×H)	375mm×287mm×52mm		
	Weight	1.5kg~2.5kg (No HDD)		
	Installation	Desk installation		

Model		NVR22-S2 Series	NVR22-P-S2 Series	NVR22-8P-S2 Series
	Mode			

1.3.9 NVR42N Series

Model		42N Series
System	System Resources	4/8/16/32-channel series product support 4/8/16/32-channel HD connection respectively. Main stream bandwidth supports 40/80/160/160Mbps respectively.
	Operation System	Embedded Linux real-time operation system
	Operation Interface	WEB/Local GUI
Decode	Video Compression	H.264/MJPEG/MPEG4
	Decode Capacity	Max supports 16-channel D1, or 8-channel 720P, or 4-channel 1080P, or 4*3M or 2*5M decode.
Video	Video Input	4/8/16/32-ch network compression video input
	Video Output	1-channel VGA analog video output.
	HDMI	1-ch HDMI output. Version number is 1.4
	Window Split	1/4/8/9/16-window
Audio	Audio Input	1-ch bidirectional talk input
	Audio Output	1-ch bidirectional talk output
	Audio Compression	G.711a
Alarm	Alarm Input	N/A
	Alarm Output	N/A
Function	Storage	2 built-in SATA ports.
	Multiple-channel Playback	Max 8-channel 720P/4-channel 1080P playback at the same time.
Port and Indicator	RS232 Port	One RS232 port to debug transparent COM data.

	RS485 port	One RS485 port to control PTZ. Support various protocols.
	USB2.0 Port	Three peripheral USB2.0 ports.
	Network Connection	1 RJ45 10/100/1000Mbps self-adaptive Ethernet port.
	Power Port	One power port, power adapter. Input DC 12V.
	Power Button	One button. At the rear panel.
	Power On-off Button	One button. At the front-panel.
	IR Receiver Window	Support IR remote control
	Clock	Built-in clock.
	Indicator Light	One power status indicator light. One network status indicator light. One HDD status indicator light.
General	Power Consumption	<30W(No HDD)
	Working Temperature	-10°C~+55°C
	Working Humidity	10%—90%
	Air pressure	86kpa—106kpa
	Dimension	375mm×287mm×52mm
	Weight	1.5kg~2.5kg (No HDD)
	Installation	Desk installation

1.3.10 NVR42/42-P/42-8P Series

Model		42 Series	42-P Series	42-8P Series
System	System Resources	4/8/16/32-channel series product support 4/8/16/32-channel HD connection respectively. Main stream bandwidth supports 40/80/160/160Mbps respectively.		

	Operation System	Embedded Linux real-time operation system		
	Operation Interface	WEB/Local GUI		
Decode	Video Compression	H.264/MJPEG/MPEG4		
	Decode Capacity	Max supports 16-channel D1, or 8-channel 720P, or 4-channel 1080P, or 4*3M or 2*5M decode.		
Video	Video Input	4/8/16/32-ch network compression video input		
	Video Output	1-channel VGA analog video output.		
	HDMI	1-ch HDMI output. Version number is 1.4		
	Window Split	1/4/8/9/16-window		
Audio	Audio Input	1-ch bidirectional talk input		
	Audio Output	1-ch bidirectional talk output		
	Audio Compression	G.711a		
Alarm	Alarm Input	4-ch alarm input		
	Alarm Output	2-ch alarm output		
Function	Storage	2 built-in SATA ports.		
	Multiple-channel Playback	Max 8-channel 720P/4-channel 1080P playback at the same time.		
Port and Indicator	RS232 Port	One RS232 port to debug transparent COM data.		
	RS485 port	One RS485 port to control PTZ. Support various protocols.		
	USB2.0 Port	Three peripheral USB2.0 ports.		
	Network Connection	1 RJ45 10/100/1000Mbps self-adaptive Ethernet port.		
	Power Port	One power port, power adapter. Input DC 12V.	Two power ports. Input DC 12V/DC 48V.	One power ports. Input 100-240V , 47~63Hz.

	Power Button	One button. At the rear panel.		
	Power On-off Button	One button. At the front-panel.		
	IR Receiver Window	Support IR remote control		
	Clock	Built-in clock.		
	Indicator Light	One power status indicator light. One network status indicator light. One HDD status indicator light.		
General	Power Consumption	<30W(No HDD)		
	Working Temperature	-10°C ~ +55°C		
	Working Humidity	10%—90%		
	Air pressure	86kpa—106kpa		
	Dimension	375mm×287mm×52mm	375mm×287mm×52mm	295mm×275mm×47mm
	Weight	1.5kg~2.5kg (No HDD)		
	Installation	Desk installation		

1.3.11 NVR42-16P Series

Model		42-16P Series
System	System Resources	16/32-channel series product support 4/8/16/32-channel HD connection respectively. Main stream/sub stream bandwidth supports 200Mbps.
	Operation System	Embedded Linux real-time operation system
	Operation Interface	WEB/Local GUI
Decode	Video Compression	H.264/MJPEG/MPEG4
	Decode Capacity	Max supports 32-channel D1, or 16-channel 720P, or 8-channel 1080P, or 4*3M or 2*5M decode.

Video	Video Input	4/8/16/32-ch network compression video input
	Video Output	1-channel VGA analog video output.
	HDMI	1-ch HDMI output. Version number is 1.4
	Window Split	1/4/8/9/16-window
Audio	Audio Input	1-ch bidirectional talk input
	Audio Output	1-ch bidirectional talk output
	Audio Compression	G.711a
Alarm	Alarm Input	4-ch alarm input
	Alarm Output	2-ch alarm output
Function	Storage	2 built-in SATA ports.
	Multiple-channel Playback	Max 16-channel 720P/8-channel 1080P playback at the same time.
Port and Indicator	RS232 Port	One RS232 port to debug transparent COM data.
	RS485 port	One RS485 port to control PTZ. Support various protocols.
	USB2.0 Port	One peripheral USB2.0 port. One peripheral USB3.0 port.
	Network Connection	1 RJ45 10/100/1000Mbps self-adaptive Ethernet port.
	Power Port	One power ports. Input 100-240V, 47~63Hz.
	Power Button	One button. At the rear panel.
	Power On-off Button	N/A
	IR Receiver Window	N/A
	Clock	Built-in clock.
	Indicator	One power status indicator light.

	Light	One network status indicator light. One HDD status indicator light.
General	Power Consumption	<30W(No HDD)
	Working Temperature	-10°C~+55°C
	Working Humidity	10%—90%
	Air pressure	86kpa—106kpa
	Dimension	375mm×287mm×52mm
	Weight	1.5kg~2.5kg (No HDD)
	Installation	Desk installation

1.3.12 NVR2A16 Series

Model		NVR2A16 Series
System	System Resources	16-ch series product support 16 HD connection respectively. Total bandwidth supports 80Mbps.
	OS	Embedded Linux real-time operation system
	Operation Interface	WEB/Local GUI
Decode	Video Decode Type	Smart H.264+/H.264
	Decode Capability	Max 4-ch 1080P 30fps or 8-ch 720P 30fs or 8-ch D1 30fps
Video	Video Input	16-ch network compression video input
	Video Output	1-channel VGA analog video output
	HDMI	1-ch HDMI output. Version number is 1.4
	Window Split	1/4/8/9/16-window
Audio	Audio Input	1-ch bidirectional talk input
	Audio Output	1-ch bidirectional talk output
	Audio Compression Standard	G.711a

Model		NVR2A16 Series
Alarm	Alarm Input	N/A
	Alarm Output	N/A
Function	Storage	2 built-in SATA ports
	Multiple-Channel Playback	Max 4-channel 1080P or 8-channel 720P or 8-channel D1 playback
Port and Indicator	RS232 Port	N/A
	RS485 Port	N/A
	USB Port	2 peripheral USB2.0 ports.
	Network Connection	1 RJ45 10/100Mbps self-adaptive Ethernet port.
	PoE Port	N/A
	Power Port	1 power socket. Power adapter power supplying mode. DC 12V power.
	Power Button	N/A
	Power On-off Button	N/A
	IR Receiver Window	N/A
	Clock	Built-in clock.
	Indicator Light	One power status indicator light. One network status indicator light. One HDD status indicator light.
General	Power Consumption	<10W (No HDD)
	Working Temperature	- 10°C ~ + 55°C
	Working Humidity	10%~90%
	Air pressure	86kPa~106kPa
	Dimension(W×D×H)	375mm×287mm×52mm
	Weight	1.5kg~2.5kg (No HDD)
	Installation Mode	Desk installation

1.3.13 NVR52-4KS2/52-8P-4KS2/52-16P-4KS2 Series

Model	NVR52-4KS2/52-8P-4KS2/52-16P-4KS2 Series
--------------	---

System	System Resources	8/16/32-channel series product support 8/16/32-channel HD connection respectively. The main stream bandwidth supports 80/160/320Mbps.
	Operation System	Embedded Linux real-time operation system
	Operation Interface	WEB/Local GUI
Decode	Video Compression	MPEG4, MJPEG, H.264, H.265
	Decode Capacity	H.264/H.265: Max supports 64-channel D1, or 32-channel 720P, 16-channel 1080P or 4-channel 4K decode.
Video	Video Input	8/16/32-ch network compression video input
	Video Output	1-channel VGA analog video output.
	HDMI	1-ch HDMI output. Version number is 2.0
	Window Split	1/4/8/9/16/25/36-window
Audio	Audio Input	1-ch bidirectional talk input
	Audio Output	1-ch bidirectional talk output
	Audio Compression	G.711a, G.711u, PCM, G.726 (The bidirectional talk function supports G.711a, G.711u, PCM only.)
Alarm	Alarm Input	4-ch alarm input
	Alarm Output	2-ch relay output
Function	Storage	2 built-in SATA ports.
	Multiple-channel Playback	Max 64-channel D1/32-channel 720P/16-channel 1080P/4-channel 4K playback at the same time.
	Record Mode	Overwrite
	Backup Mode	Flash disk, DVD burner.
Port and Indicator	Network Protocol	IPv4/IPv6/HTTP/UPnP/NTP/SADP/SNMP/PPPoE/DNS/FTP/ONVIF(Version 2.4)/PSIA
	RS232 Port	One RS232 port to debug transparent COM data.

	RS485 port	One RS485 port to control PTZ. Support various protocols.
	USB Port	2 peripheral USB ports: One USB2.0 at the front panel and one USB3.0 at the rear panel.
	Network Connection	One RJ45 10/100/1000Mbps self-adaptive Ethernet port.
	Power Port	One power socket. Power adapter power supplying. Input DC 12V-4A power.
	Power Button	One button. At the rear panel.
	Power On-off Button	N/A
	IR Receiver Window	N/A
General	Indicator Light	One power status indicator light. One network status indicator light. One HDD status indicator light. One device running status indicator light.
	Power	DC 12V
	Power Consumption	General series: 9.5W(No HDD) 8 PoE series: 14.5W(No HDD) 16 PoE series: 15.2W(No HDD)
	Working Temperature	-10°C ~ +55°C
	Working Humidity	10%—90%
	Air pressure	86kpa—106kpa
	Dimension	General series: 375mm(W) × 56mm(H) × 281.4mm(D) PoE series: 375mm(W) × 53mm(H) × 327.3mm(D)
	Weight (No HDD)	General series: : 1.60Kg 8 PoE series: 2.60Kg 16 PoE series: 2.70Kg
	Installation	Desk/rack installation

1.3.14 NVR44/44-8P/44-16P Series

Model	NVR44 Series	NVR44-8P Series	NVR44-16P Series

System	System Resources	8/16/32-channel series product support 8/16/32-channel HD connection respectively. The main stream bandwidth supports 200Mbps.
	Operation System	Embedded Linux real-time operation system
	Operation Interface	WEB/Local GUI
Decode	Video Compression	H.264/MJPEG/MPEG4
	Decode Capacity	Max supports 16-channel D1, or 8-channel 720P, or 4-channel 3M or 2*5M decode.
Video	Video Input	8/16/32-ch network compression video input
	Video Output	1-channel VGA analog video output.
	HDMI	1-ch HDMI output. Version number is 1.4
	Window Split	1/4/8/9/16-window
Audio	Audio Input	1-ch bidirectional talk input
	Audio Output	1-ch bidirectional talk output
	Audio Compression	G.711a
Alarm	Alarm Input	16-ch alarm input
	Alarm Output	4-ch alarm output Relay output. Relay (DC 30V /1A, AC 125V/0.5A (Activation output)) Including one controllable DC +12V output.
Function	Storage	4 built-in SATA ports. 1 external eSATA port.
	Multiple-channel Playback	Max 8-channel 720P/4-channel 1080P playback at the same time.
Port and Indicator	RS232 Port	One RS232 port to debug transparent COM data.
	RS485 port	One RS485 port to control PTZ. Support various protocols.
	USB2.0 Port	2 peripheral USB2.0 ports. One at the front panel and one at the rear panel.
	Network Connection	One RJ45 10/100/1000Mbps self-adaptive Ethernet port.

	Power Port	One power port. Input 100-240V, 50~60Hz.
	Power Button	One button. At the rear panel.
	Power On-off Button	One button. At the front-panel.
	IR Receiver Window	Support IR remote control
	Clock	Built-in clock.
General	Indicator Light	One power status indicator light. One network status indicator light. One HDD status indicator light.
	Power Consumption	<30W(No HDD)
	Working Temperature	-10°C~+55°C
	Working Humidity	10%—90%
	Air pressure	86kpa—106kpa
	Dimension	1.5U, 440mm x 460mm x 68mm
	Weight	5kg~6kg (No HDD)
	Installation	Desk installation

1.3.15 NVR54-4KS2/54-16P-4KS2 Series

Specifications		NVR54-4KS2/54-16P-4KS2 Series
System	Main Processor	Industrial embedded micro processor
	Operation System	Embedded LINUX system
	System Resources	16/32/64-channel main stream connection: max supports 160/320/320Mbps
	User Interface	WEB, local GUI
Audio Parameters	Audio Input	1-ch MIC bidirectional talk audio input
	Audio Output	2-ch MIC bidirectional talk audio output
	Audio Compression Standard	G.711a, G.711u, PCM, G.726 (The bidirectional talk supports G.711a, G.711u, PCM only.)

Video Parameters	Video Input	16/32/64-ch network compression video input
	Video Output	2-channel VGA 2-channel HDMI.
	Video Compression Standard	H.264
	Window Split Mode	1/4/8/9/16/25/36/64-screen.
Alarm Parameters	Alarm Input	16-channel
	Alarm Output	6-channel relay output
Decode Parameters	Decode Type	MPEG4, MJPEG, H.264, H.265
	Decode Capability	H.264/H.265: 64-channel×D1, 32-channel×720P, 16-channel 1080P; 4-channel 4K.
Functions	Record Mode	Manual recording, motion detection recording, schedule recording and alarm recording. Priority: Manual recording>card number recording-> alarm recording>motion detection recording>schedule recording.
	Multi-Channel Playback	Max support 16-channel 1080P playback at the same time.
	Motion Detect	Each screen supports 396/330((PAL 22×18, NTSC 22×15) detection zones. Various sensitivity levels.
	Privacy Mask	Each channel supports 4 privacy mask zones.
	Record Mode	Overwrite
	Backup Mode	Flash disk, eSATA, DVD burner.
Network Function	Network Protocol	IPv4/IPv6/HTTP/UPnP/NTP/SADP/SNMP/PPPoE/DNS/FTP/ONVIF(Version 2.4)/PSIA
	SATA Port	4 SATA Ports
	eSATA Port	1 eSATA port
	RS232 Port	1 RS232 port. To debug and transmit COM data.
	RS485 Port	1 RS485 port. To control peripheral PTZ and etc. Support various protocols.
	USB Port	1 USB 2.0 port at the front panel and 2 USB3.0 ports at the rear panel.
	HDMI Port	2 HDMI ports
	Network Port	2 RJ45 10/100/1000Mbps self-adaptive Ethernet ports
	Power Port	One power socket. Power adapter power supplying. Input AC 100V~240V, 50Hz~60Hz.
	Power On-off Button	One at the rear panel.

	Indicator Light	4 indicator lights. <ul style="list-style-type: none"> ● 1 system running status indicator light ● 1 HDD indicator light ● 1 network status indicator light ● 1 power status indicator light
General Parameters	Power	AC90~264V
	Power Consumption	General series: 16.7W (No HDD) 16 PoE series: 17.5W (No HDD)
	Working Temperature	-10℃~55℃
	Working Humidity	10%~90% (No condensation)
	Dimensions (W×H×D)	440×76×411mm
	Weight(No HDD)	General series:4.30Kg, PoE series: 4.65Kg,
	Installation Mode	Rack/desktop

1.3.16 NVR58-4KS2/58-16P-4KS2 Series

Specifications		NVR58-4KS2/58-16P-4KS2 Series
System	Main Processor	Industrial embedded micro processor
	Operation System	Embedded LINUX system
	System Resources	16/32/64-channel main stream max supports 160/320/320Mbps
	User Interface	WEB, local GUI
Audio Parameters	Audio Input	1-ch MIC bidirectional talk audio input
	Audio Output	2-ch MIC bidirectional talk audio output
	Audio Compression Standard	G.711a, G.711u, PCM, G.726 (The bidirectional talk supports G.711a, G.711u, PCM only.)
Video Parameters	Video Input	16/32/64-ch network compression video input
	Video Output	2-channel VGA 2-channel HDMI.
	Video Compression Standard	H.264
	Window Split Mode	1/4/8/9/16/25/36/64-screen.
Alarm Parameters	Alarm Input	16-channel
	Alarm Output	6-channel relay output
Decode Parameters	Decode Type	MPEG4, MJPEG, H.264, H.265
	Decode Capability	H.264/H.265: 64-channel×D1;32-channel×720P, 16-channel 1080P;4-channel 4K

Functions	Record Mode	Manual recording, motion detection recording, schedule recording and alarm recording. Priority: Manual recording>card number recording-> alarm recording>motion detection recording>schedule recording.
	Multi-Channel Playback	Max support 16-channel 1080P playback at the same time.
	Motion Detect	Each screen supports 396/330((PAL 22x18, NTSC 22x15) detection zones. Various sensitivity levels.
	Privacy Mask	Each channel supports 4 privacy mask zones.
	Record Mode	Overwrite
	Backup Mode	Flash disk, eSATA, DVD burner.
Network Function	Network Protocol	IPv4/IPv6/HTTP/UPnP/NTP/SADP/SNMP/PPPoE/DNS/FTP/ONVIF(Version 2.4)/PSIA
	SATA Port	8 SATA Ports
	eSATA Port	1 eSATA port
	RS232 Port	1 RS232 port. To debug and transmit COM data.
	RS485 Port	1 RS485 port. To control peripheral PTZ and etc. Support various protocols.
	USB Port	2 USB 2.0 ports at the front panel and 2 USB3.0 ports at the rear panel.
	HDMI Port	2 HDMI ports
	Network Port	2 RJ45 10/100/1000Mbps self-adaptive Ethernet ports
	Power Port	One power socket. Power adapter power supplying. Input AC 100V~240V, 50Hz~60Hz.
	Power On-off Button	One at the rear panel.
	Indicator Light	4 indicator lights. <ul style="list-style-type: none"> ● 1 system running status indicator light ● 1 HDD indicator light ● 1 network status indicator light ● 1 power status indicator light
General Parameters	Power	AC90~264V
	Power Consumption	General series: 16.7W (No HDD) 16 PoE series: 17.5W (No HDD)
	Working Temperature	-10℃~55℃
	Working Humidity	10%~90% (No condensation)
	Dimensions (W×H×D)	439.7×95×450.8mm
	Weight (No HDD)	General series:6.55Kg, PoE series: 7Kg.
	Installation Mode	Rack/desktop

1.3.17 NVR48/48-16P Series

Model		NVR48 Series	NVR48-16P Series
System	System Resources	8/16/32-channel series product support 8/16/32-channel HD connection respectively. The main stream bandwidth supports 200Mbps.	
	Operation System	Embedded Linux real-time operation system	
	Operation Interface	WEB/Local GUI	
Decode	Video Compression	H.264/MJPEG/MPEG4	
	Decode Capacity	Max supports 16-channel D1, or 8-channel 720P, or 4-channel 3M or 2*5M decode.	
Video	Video Input	8/16/32-ch network compression video input	
	Video Output	1-channel VGA analog video output.	
	HDMI	1-ch HDMI output. Version number is 1.4	
	Window Split	1/4/8/9/16-window	
Audio	Audio Input	1-ch bidirectional talk input	
	Audio Output	1-ch bidirectional talk output	
	Audio Compression	G.711a	
Alarm	Alarm Input	16-ch alarm input	
	Alarm Output	4-ch alarm output Relay output. Relay (DC 30V /1A, AC 125V/0.5A (Activation output)) Including one controllable DC +12V output.	
Function	Storage	4 built-in SATA ports. 1 external eSATA port.	
	Multiple-channel Playback	Max 8-channel 720P/4-channel 1080P playback at the same time.	
Port and Indicator	RS232 Port	One RS232 port to debug transparent COM data.	
	RS485 port	One RS485 port to control PTZ. Support various protocols.	
	USB2.0 Port	3 peripheral USB2.0 ports. Two at the front panel and one at the rear panel.	

	Network Connection	Two RJ45 10/100/1000Mbps self-adaptive Ethernet ports.	One RJ45 10/100/1000Mbps self-adaptive Ethernet port.
	Power Port	One power port. Input 100-240V, 50~60Hz.	
	Power Button	One button. At the rear panel.	
	Power On-off Button	One button. At the front-panel.	
	IR Receiver Window	Support IR remote control	
	Clock	Built-in clock.	
General	Indicator Light	One power status indicator light. One network status indicator light. One HDD status indicator light.	
	Power Consumption	<30W(No HDD)	
	Working Temperature	-10°C~+55°C	
	Working Humidity	10%—90%	
	Air pressure	86kpa—106kpa	
	Dimension	440mm x 460mm x 89mm	
	Weight	5.5kg~6.5kg (No HDD)	
	Installation	Desk installation	

1.3.18 NVR42V-8P Series

Model		NVR42V-8P
System	System Resources	8/16/32-channel series product support 8/16/32-channel HD connection respectively. Main stream bandwidth supports 80/160/160Mbps respectively.
	Operation System	Embedded Linux real-time operation system
	Operation Interface	WEB/Local GUI

Decode	Video Compression	H.264/MJPEG/MPEG4
	Decode Capacity	Max supports 16-channel D1, or 8-channel 720P, or 4-channel 1080P, or 4*3M or 2*5M decode.
Video	Video Input	8/16/32-ch network compression video input
	Video Output	1-channel VGA analog video output.
	HDMI	1-ch HDMI output. Version number is 1.4
	Window Split	1/4/8/9/16-window
Audio	Audio Input	1-ch bidirectional talk input
	Audio Output	1-ch bidirectional talk output
	Audio Compression	G.711a
Alarm	Alarm Input	2-ch alarm input
	Alarm Output	1-ch alarm output
Function	Storage	2 built-in SATA ports.
	Multiple-channel Playback	Max 8-channel 720P/4-channel 1080P playback at the same time.
Port and Indicator	RS232 Port	N/A
	RS485 port	N/A
	USB Port	Two USB2.0 ports at the front panel and one USB3.0 port at the rear panel. .
	Network Connection	1 RJ45 10/100/1000Mbps self-adaptive Ethernet port and 8 PoE ports.
	Power Port	One power port. Input DC 53V--2.3A
	Power Button	One button. At the rear panel.
	Power On-off Button	N/A
	IR Receiver Window	Support IR remote control
	Clock	Built-in clock.

	Indicator Light	One power status indicator light. One network status indicator light. One HDD status indicator light. One alarm status indicator light.
General	Power Consumption	<30W(No HDD)
	Working Temperature	-10℃~+55℃
	Working Humidity	10%—90%
	Air pressure	86kpa—106kpa
	Dimension	100mmx220mmx146mm
	Weight	1.5kg~2.5kg (No HDD)
	Installation	Desk installation

1.3.19 NVR41-4KS2/41-P-4KS2/41-8P-4KS2 Series

Model		41-4KS2 Series	41-P-4KS2 Series	41-8P-4KS2 Series
System	Main Processor	Industrial embedded micro processor		
	OS	Embedded Linux operation system		
	System Resources	4/8/16-channel series product main stream max support 80/80/80Mbps	4/8-channel series product main stream max support 80/80Mbps	8/16-channel series product main stream max support 80/80Mbps
	Operation Interface	WEB/Local GUI		
Audio	Audio Input	1-ch MIC bidirectional talk input		
	Audio Output	1-ch MIC bidirectional talk output		
	Audio Compression Standard	G.711a/G.711u/AAC/G.722.1/G726/G.729		
Video	Video Input	4/8/16-ch network compression video input	4/8-ch network compression video input	8/16-ch network compression video input
	Video Output	1-channel VGA video output, 1-channel HDMI output		
	Video Compression Standard	H.264		

Model		41-4KS2 Series	41-P-4KS2 Series	41-8P-4KS2 Series
	Window Split	1/4/8/9/16-window	1/4/8/9-window	1/4/8/9/16-window
Alarm	Alarm Input	N/A (Compatble with 2in/1out alarm panel)		N/A
	Alarm Output	N/A(Compatble with 2in/1out alarm panel)		N/A
Decode	Decode Type	MPEG4/MJPEG/H.264/H.265		
	Decode Capability	H.264/H.265: 16-channel D1 or 16-channel 720P or 8-channel 1080P or 2-channel 4K		
Function	Record Mode	Manual record, motion detect record, schedule record, alarm record. The record priority: Manual record>Alarm record>Motion detect record>Schedule record		
	Multiple-Channel Playback	Max 8-channel 1080P playback		
	Motion Detect	Each video supports PAL 396(22*18)/ NTSC 330(22x15) detection zones, support multiple sensivityly levels.		
	Privacy Mask	Each channel supports 4 privacy mask zones		
	Record Storage	Overwrite		
	Backup Mode	USB device/DVD burner		
Port and Indicator	Network Protocol	IPv4/IPv6/HTTP/UPnP/NTP/SADP/SNMP/PPPoE/DNS/FTP/ONVI(Version2.4)/PSIA		
	SATA Port	One port		
	eSATA Port	N/A		
	RS232 Port	N/A		
	RS485 Port	N/A		
	USB Port	2 peripheral USB2.0 ports at the rear panel		
	Network Connection	1 RJ45 10/100Mbps self-adaptive Ethernet port.		
	PoE Port	N/A	4	8
	HDMI Port	One port		
	VGA Port	One port		
	Power Port	1 power socket. Power adapter power supplying mode. DC 12V/2A	1 power socket. Power adapter power supplying mode. DC 48V/72W	1 power socket. Power adapter power supplying

Model		41-4KS2 Series	41-P-4KS2 Series	41-8P-4KS2 Series
		power.	power.	mode. DC 48V/96W power.
	Power On-off Button	N/A		
	Indicator Light	Three indicator lights.		
General	Power Consumption	< 10W (No HDD)		
	Working Temperature	- 10°C ~ + 55°C		
	Working Humidity	10%~90%		
	Air pressure	86kPa~106kPa		
	Dimensions(m m)	205.3*45.6*204.2(D*H*W)		
	Weight	0.5kg~1kg (No HDD)		
	Installation Mode	Desk/rack installation		

1.3.20 NVR41HS-4KS2/ 41HS-P-4KS2/41HS-8P-4KS2 Series

Model		41HS-4KS2 Series	41HS-P-4KS2 Series	41HS-8P-4KS2 Series
System	Main Processor	Industrial embedded micro processor		
	OS	Embedded Linux operation system		
	System Resources	4/8/16-channel series product main stream max support 80/80/80Mbps	4/8-channel series product main stream max support 80/80Mbps	8/16-channel series product main stream max support 80/80Mbps
	Operation Interface	WEB/Local GUI		
Audio	Audio Input	1-ch MIC bidirectional talk input		
	Audio Output	1-ch MIC bidirectional talk output		
	Audio Compression Standard	G.711a/G.711u/AAC/G.722.1/G726/G.729		
Video	Video Input	4/8/16-ch network compression video	4/8-ch network compression video	8/16-ch network compression video

Model		41HS-4KS2 Series	41HS-P-4KS2 Series	41HS-8P-4KS2 Series
		input	input	input
	Video Output	1-channel VGA video output, 1-channel HDMI output		
	Video Compression Standard	H.264		
	Window Split	1/4/8/9/16-window	1/4/8/9-window	1/4/8/9/16-window
Alarm	Alarm Input	N/A (Compatble with 2in/1out alarm panel)		
	Alarm Output	N/A(Compatble with 2in/1out alarm panel)		
Decode	Decode Type	MPEG4/MJPEG/H.264/H.265		
	Decode Capability	H.264/H.265: 16-channel D1 or 16-channel 720P or 8-channel 1080P or 2-channel 4K		
Function	Record Mode	Manual record, motion detect record, schedule record, alarm record. The record priority: Manual record>Alarm record>Motion detect record>Schedule record		
	Multiple-Channel Playback	Max 8-channel 1080P playback		
	Motion Detect	Each video supports PAL 396(22*18)/ NTSC 330(22x15) detection zones, support multiple sensivityly levels.		
	Privacy Mask	Each channel supports 4 privacy mask zones		
	Record Storage	Overwrite		
	Backup Mode	USB device/DVD burner		
Port and Indicator	Network Protocol	IPv4/IPv6/HTTP/UPnP/NTP/SADP/SNMP/PPPoE/DNS/FTP/ONVI(Version2.4)/PSIA		
	SATA Port	One port		
	eSATA Port	N/A		
	RS232 Port	N/A		
	RS485 Port	N/A		
	USB Port	2 peripheral USB ports: one USB 2.0 port at the front panel and one USB3.0 port at the rear panel		

Model		41HS-4KS2 Series	41HS-P-4KS2 Series	41HS-8P-4KS2 Series
	Network Connection	1 RJ45 10/100Mbps self-adaptive Ethernet port.		
	PoE Port	N/A	4	8
	HDMI Port	One port		
	VGA Port	One port		
	Power Port	1 power socket. Power adapter power supplying mode. DC 12V/2A power.	1 power socket. Power adapter power supplying mode. DC 48V/72W power.	1 power socket. Power adapter power supplying mode. DC 48V/96W power.
	Power On-off Button	N/A		
	Indicator Light	Three indicator lights.		
General	Power Consumption	6.3W (No HDD)	7.5W (No HDD)	8.3W (No HDD)
	Working Temperature	- 10°C ~ + 55°C		
	Working Humidity	10%~90%		
	Air pressure	86kPa~106kPa		
	Dimensions(m m)	224.9*47.6*260(D*H*W)		
	Weight	1.2Kg (No HDD)	1.6Kg (No HDD)	2.1Kg (No HDD)
	Installation Mode	Desk/rack installation		

1.3.21 NVR42-4KS2/42-P-4KS2/42-8P-4KS2/42-16P-4KS2 Series

Model		42-4KS2 Series	42-P-4KS2 Series	42-8P-4KS2 Series	42-16P-4KS2 Series
System	Main Processor	Industrial embedded micro processor			
	OS	Embedded Linux operation system			
	System Resources	8/16/32-channel series product main stream max support 200/200/200M	4-channel series product main stream max support 200Mbps	8-channel series product main stream max support 200Mbps	16/32-channel series product main stream max support 200/200Mbps

Model		42-4KS2 Series	42-P-4KS2 Series	42-8P-4KS2 Series	42-16P-4KS2 Series
		bps			
	Operation Interface	WEB/Local GUI			
Audio	Audio Input	1-ch MIC bidirectional talk input			
	Audio Output	1-ch MIC bidirectional talk output			
	Audio Compression Standard	G.711a/G.711u/AAC/G.722.1/G726/G.729			
Video	Video Input	8/16/32-ch network compression video input	4-ch network compression video input	8-ch network compression video input	16/32-ch network compression video input
	Video Output	1-channel VGA video output, 1-channel HDMI output			
	Video Compression Standard	H.264			
	Window Split	1/4/8/9/16/32-window	1/4-window	1/4/8/9-window	1/4/8/9/16/32-window
Alarm	Alarm Input	4-channel input			
	Alarm Output	2-channel output: 1-channel relay output, 1-channel 12V control			
Decode	Decode Type	MPEG4/MJPEG/H.264/H.265			
	Decode Capability	H.264/H.265: 32-channel D1 or 16-channel 720P or 8-channel 1080P or 2-channel 4K			
Function	Record Mode	Manual record, motion detect record, schedule record, alarm record. The record priority: Manual record>Alarm record>Motion detect record>Schedule record			
	Multiple-Channel Playback	Max 8-channel 1080P playback			
	Motion Detect	Each video supports PAL 396(22*18)/ NTSC 330(22*15) detection zones, support multiple sensitivity levels.			

Model		42-4KS2 Series	42-P-4KS2 Series	42-8P-4KS2 Series	42-16P-4KS2 Series
	Privacy Mask	Each channel supports 4 privacy mask zones			
	Record Storage	Overwrite			
	Backup Mode	USB device/DVD burner			
Port and Indicator	Network Protocol	IPv4/IPv6/HTTP/UPnP/NTP/SADP/SNMP/PPPoE/DNS/FTP/ONVI(Version2.4)/PSIA			
	SATA Port	Two ports			
	eSATA Port	N/A			
	RS232 Port	N/A			
	RS485 Port	N/A			
	USB Port	2 peripheral USB ports: one USB 2.0 port at the front panel and one USB3.0 port at the rear panel			
	Network Connection	1 RJ45 10/100/1000Mbps self-adaptive Ethernet port.			
	PoE Port	N/A	4	8	16
	HDMI Port	One port			
	VGA Port	One port			
	Power Port	1 power socket. Power adapter power supplying mode. DC 12V/4A power.	1 power socket. Power adapter power supplying mode. DC 48V/96W power.	1 power socket. Power adapter power supplying mode. AC90V~264V-12V5A/52V2.5 A-190W power.	1 power socket. Power adapter power supplying mode. AC90V~264V-12V5A/52V2.5 A-190W power.
	Power On-off Button	One at the rear panel			
	Indicator Light	Four indicator lights.			
General	Power Consumption	4.2W (No HDD) 21.72W (With HDD)			
	Working Temperature	- 10°C ~ + 55°C			
	Working Humidity	10%~90%			
	Air pressure	86kPa~106kPa			

Model		42-4KS2 Series	42-P-4KS2 Series	42-8P-4KS2 Series	42-16P-4KS2 Series
	Dimensions(m m)	320mm x 48.2mm x 375mm(D*H*W)			
	Weight	3.2Kg (No HDD)		4.1Kg (No HDD)	
	Installation Mode	Desk/rack installation			

1.3.22 NVR5224-24P-4KS2 Series

Model		NVR5224-24P-4KS2 Series
System	Main Processor	Industrial embedded micro processor
	System Resources	24-channel series product support 24-channel HD connection. The main stream bandwidth supports 320Mbps.
	Operation System	Embedded Linux real-time operation system
	Operation Interface	WEB/Local GUI
Decode	Video Compression	MPEG4, MJPEG, H.264, H.265
	Decode Capacity	H.264/H.265: Max supports 24-channel D1, or 24-channel 720P, 16-channel 1080P or 4-channel 4K decode.
Video	Video Input	24-ch network compression video input
	Video Output	1-channel VGA analog video output.
	HDMI	1-ch HDMI output.
	Window Split	1/4/8/9/16/25 and customized-window
Audio	Audio Input	1-ch bidirectional talk input
	Audio Output	1-ch bidirectional talk output
	Audio Compression	G.711a, G.711u, PCM, G.726 (The bidirectional talk function supports G.711a, G.711u, PCM only.)
Alarm	Alarm Input	4-ch alarm input
	Alarm Output	2-ch relay output
Function	Record Mode	Manual recording, motion detection recording, schedule recording and alarm recording. Priority: Manual recording>alarm recording>motion detection recording>schedule recording.

	Multiple-channel Playback	Max 16-channel 1080P playback at the same time.
	Motion Detect	Each screen supports 396/330((PAL 22×18, NTSC 22×15) detection zones. Various sensitivity levels.
	Privacy Mask	Each channel supports 4 privacy mask zones.
	Record Mode	Overwrite
	Backup Mode	Flash disk, DVD burner.
Port and Indicator	Network Protocol	IPv4/IPv6/HTTP/UPnP/NTP/SADP/SNMP/PPPoE/DNS/FTP/ONVIF(Version 2.4)/PSIA
	SATA Port	2
	RS232 Port	One RS232 port to debug transparent COM data.
	RS485 port	One RS485 port to control PTZ. Support various protocols.
	USB Port	2 peripheral USB ports: One USB2.0 at the front panel and one USB3.0 at the rear panel.
	HDMI Port	1
	Network Connection	One RJ45 10/100/1000Mbps self-adaptive Ethernet port.
	Power Port	One power socket. Input 100V-240V, 50Hz~60Hz.
	Power Button	One button. At the rear panel.
	Power On-off Button	N/A
	IR Receiver Window	N/A
General	Indicator Light	One power status indicator light. One network status indicator light. One HDD status indicator light.
	Power	AC100V~240V
	Power Consumption	16W(No HDD)
	Working Temperature	-10℃~+55℃
	Working Humidity	10%—90%

	Air pressure	86kpa – 106kpa
	Dimension	420mm×482.6 mm×44 mm
	Weight (No HDD)	4.5Kg
	Installation	Desk/rack installation

1.3.23 NVR44-4KS2/44-16P-4KS2 Series

Model		44-4KS2 Series	44-16P-4KS2 Series
System	Main Processor	Industrial embedded micro processor	
	OS	Embedded Linux operation system	
	System Resources	16/32-channel series product main stream max support 200/200Mbps	16/32-channel series product main stream max support 200/200Mbps
	Operation Interface	WEB/Local GUI	
Audio	Audio Input	1-ch MIC bidirectional talk input	
	Audio Output	1-ch MIC bidirectional talk output	
	Audio Compression Standard	G.711a/G.711u/AAC/G.722.1/G726/G.729	
Video	Video Input	16/32-ch network compression video input	
	Video Output	1-channel VGA video output, 1-channel HDMI output	
	Video Compression Standard	H.264	
	Window Split	1/4/8/9/16/32-window	
Alarm	Alarm Input	16-channel input	
	Alarm Output	4-channel output:3-channel relay output, 1-channel 12V control	
Decode	Decode Type	MPEG4/MJPEG/H.264/H.265	
	Decode Capability	H.264/H.265: 32-channel D1 or 16-channel 720P or 8-channel 1080P or 2-channel 4K	
Function	Record Mode	Manual record, motion detect record, schedule record, alarm record. The record priority: Manual record>Alarm record>Motion detect record>Schedule record	

Model		44-4KS2 Series	44-16P-4KS2 Series	
	Multiple-Channel Playback	Max 8-channel 1080P playback		
	Motion Detect	Each video supports PAL 396(22*18)/ NTSC 330(22x15) detection zones, support multiple sensitivity levels.		
	Privacy Mask	Each channel supports 4 privacy mask zones		
	Record Storage	Overwrite		
	Backup Mode	USB device/DVD burner		
Port and Indicator	Network Protocol	IPv4/IPv6/HTTP/UPnP/NTP/SADP/SNMP/PPPoE/DNS/FTP/ONVI(Version2.4)/PSIA		
	SATA Port	Four ports		
	eSATA Port	N/A		
	RS232 Port	N/A		
	RS485 Port	N/A		
	USB Port	2 peripheral USB ports: one USB 2.0 port at the front panel and one USB3.0 port at the rear panel		
	Network Connection	Two RJ45 10/100/1000Mbps self-adaptive Ethernet ports. One Ethernet card	One RJ45 10/100/1000Mbps self-adaptive Ethernet port	
	PoE Port	N/A	16	
	HDMI Port	One port		
	VGA Port	One port		
	Power Port	1 power socket. Power adapter power supplying mode. AC90V~264V-12V5.7A/-12V0.5A-75W	1 power socket. Power adapter power supplying mode. AC90V~264V-12V12.5A/-53V2.83A	
	Power On-off Button	One at the rear panel		
	Indicator Light	Four indicator lights.		
General	Power Consumption	4.2W (No HDD) 21.72W (With HDD)		
	Working Temperature	- 10°C ~ + 55°C		
	Working Humidity	10%~90%		
	Air pressure	86kPa~106kPa		

Model		44-4KS2 Series	44-16P-4KS2 Series
	Dimensions(m m)	405*72*440(D*H*W)	
	Weight	7.00Kg (No HDD)	
	Installation Mode	Desk/rack installation	

1.3.24 NVR5424-24P-4KS2 Series

Model		NVR5424-24P-4KS2 Series
System	Main Processor	Industrial embedded micro processor
	System Resources	24-channel series product support 24-channel HD connection. The main stream bandwidth supports 320Mbps.
	Operation System	Embedded Linux real-time operation system
	Operation Interface	WEB/Local GUI
Decode	Video Compression	MPEG4, MJPEG, H.264, H.265
	Decode Capacity	H.264/H.265: Max supports 24-channel D1, or 24-channel 720P, 16-channel 1080P or 4-channel 4K decode.
Video	Video Input	24-ch network compression video input
	Video Output	1-channel VGA analog video output.
	HDMI	1-ch HDMI output.
	Window Split	1/4/8/9/16/25 and customized-window
Audio	Audio Input	1-ch bidirectional talk input
	Audio Output	1-ch bidirectional talk output
	Audio Compression	G.711a, G.711u, PCM, G.726 (The bidirectional talk function supports G.711a, G.711u, PCM only.)
Alarm	Alarm Input	16-ch alarm input
	Alarm Output	6-ch relay output
Function	Record Mode	Manual recording, motion detection recording, schedule recording and alarm recording. Priority: Manual recording>alarm recording>motion detection recording>schedule recording.
	Multiple-channel Playback	Max 16-channel 1080P playback at the same time.
	Motion Detect	Each screen supports 396/330((PAL 22×18, NTSC 22×15) detection zones. Various sensitivity levels.

	Privacy Mask	Each channel supports 4 privacy mask zones.
	Record Mode	Overwrite
	Backup Mode	Flash disk, DVD burner.
Port and Indicator	Network Protocol	IPv4/IPv6/HTTP/UPnP/NTP/SADP/SNMP/PPPoE/DNS/FTP/ONVIF(Version 2.4)/PSIA
	SATA Port	4
	eSATA Port	1
	RS232 Port	One RS232 port to debug transparent COM data.
	RS485 port	One RS485 port to control PTZ. Support various protocols.
	USB Port	3 peripheral USB ports: One USB2.0 at the front panel and two USB3.0 ports at the rear panel.
	HDMI Port	2
	Network Connection	Two RJ45 10/100/1000Mbps self-adaptive Ethernet ports.
	Power Port	One power socket. Input 100V-240V, 50Hz~60Hz.
	Power Button	One button. At the rear panel.
	Power On-off Button	N/A
	IR Receiver Window	N/A
	General	Indicator Light
Power		AC100V~240V
Power Consumption		18W(No HDD)
Working Temperature		-10℃~+55℃
Working Humidity		10%—90%
Air pressure		86kpa—106kpa
Dimension		414mm×482 mm×76mm
Weight (No HDD)		4.7Kg

	Installation	Desk/rack installation
--	---------------------	------------------------

1.3.25 NVR48-4KS2/48-16P-4KS2 Series

Model		48-4KS2 Series	48-16P-4KS2 Series
System	Main Processor	Industrial embedded micro processor	
	OS	Embedded Linux operation system	
	System Resources	16/32-channel series product main stream max support 200/200Mbps	16/32-channel series product main stream max support 200/200Mbps
	Operation Interface	WEB/Local GUI	
Audio	Audio Input	1-ch MIC bidirectional talk input	
	Audio Output	1-ch MIC bidirectional talk output	
	Audio Compression Standard	G.711a/G.711u/AAC/G.722.1/G726/G.729	
Video	Video Input	16/32-ch network compression video input	
	Video Output	1-channel VGA video output, 1-channel HDMI output	
	Video Compression Standard	H.264	
	Window Split	1/4/8/9/16/32-window	
Alarm	Alarm Input	16-channel input	
	Alarm Output	4-channel output:3-channel relay output, 1-channel 12V control	
Decode	Decode Type	MPEG4/MJPEG/H.264/H.265	
	Decode Capability	H.264/H.265: 32-channel D1 or 16-channel 720P or 8-channel 1080P or 2-channel 4K	
Function	Record Mode	Manual record, motion detect record, schedule record, alarm record. The record priority: Manual record>Alarm record>Motion detect record>Schedule record	
	Multiple-Channel Playback	Max 8-channel 1080P playback	
	Motion Detect	Each video supports PAL 396(22*18)/ NTSC 330(22*15) detection	

Model		48-4KS2 Series	48-16P-4KS2 Series
		zones, support multiple sensitivity levels.	
	Privacy Mask	Each channel supports 4 privacy mask zones	
	Record Storage	Overwrite	
	Backup Mode	USB device/DVD burner	
Port and Indicator	Network Protocol	IPv4/IPv6/HTTP/UPnP/NTP/SADP/SNMP/PPPoE/DNS/FTP/ONV1(Version2.4)/PSIA	
	SATA Port	Eight ports	
	eSATA Port	N/A	
	RS232 Port	N/A	
	RS485 Port	One A/B port	
	USB Port	Three peripheral USB ports: Two USB 2.0 ports at the front panel and one USB3.0 port at the rear panel	
	Network Connection	Two RJ45 10/100/1000Mbps self-adaptive Ethernet ports. One Ethernet card	One RJ45 10/100/1000Mbps self-adaptive Ethernet port.
	PoE Port	N/A	16
	HDMI Port	One port	
	VGA Port	One port	
	Power Port	1 power socket. Power adapter power supplying mode. AC90V~264V-12V12.5A	1 power socket. Power adapter power supplying mode. AC90V~264V-12V12.5A/-53V2.83A
	Power On-off Button	One at the rear panel	
Indicator Light	Four indicator lights.		
General	Power Consumption	4.2W (No HDD) 21.72W (With HDD)	
	Working Temperature	- 10°C ~ + 55°C	
	Working Humidity	10%~90%	
	Air pressure	86kPa~106kPa	
	Dimensions(mm)	445.5mm×90.65mm×439.7mm(D*H*W)	
	Weight	9.80Kg (No HDD)	

Model		48-4KS2 Series	48-16P-4KS2 Series
	Installation Mode	Desk/rack installation	

1.3.26 NVR21-4KS2/21-P-4KS2/21-8P-4KS2 Series

Model		21-4KS2 Series	21-P-4KS2 Series	21-8P-4KS2 Series
System	System Resources	4/8/16-ch series product support 4/8/16 HD connection respectively. Total bandwidth supports 80Mbps.	4-ch series product support 4 HD connection. Total bandwidth supports 80Mbps.	8-ch series product support 8 HD connection. Total bandwidth supports 80Mbps.
	OS	Embedded Linux operation system		
	Operation Interface	WEB/Local GUI		
Decode	Video Decode Type	H.264;H265;MPEG4		
	Decode Capability	Max 1-ch 4K, 1-ch 6M,1-ch 5M, 2-ch 4M, 4-ch 1080P or 8-ch 720P		
Video	Video Input	4/8/16-ch network compression video input	4-ch network compression video input	8-ch network compression video input
	Video Output	1-channel VGA analog video output 1-channel HDMI video output, HDMI version is 1.4. VGA and HDMI output the video from the same video source.		
	Video Compression Standard	N/A		
	Window Split	1/4/8/9/16-window	1/4-window	1/4/8/9-window

Model		21-4KS2 Series	21-P-4KS2 Series	21-8P-4KS2 Series
Audio	Audio Input	1-ch bidirectional talk input		
	Audio Output	1-ch bidirectional talk output		
	Audio Compression Standard	PCM,G.711a,G711u		
Alarm	Alarm Input	N/A		
	Alarm Output	N/A		
Function	Record Mode	Manual record, motion detect record, schedule record, alarm record. The record priority: Manual record>Alarm record>Motion detect record>Schedule record		
	Multiple-Channel Playback	Max 4-channel 1080P playback		
	Motion Detect	Each video supports PAL 396(22*18)/ NTSC 330(22x15) detection zones, support multiple sensitivity levels.		
	Privacy Mask	Each channel supports 4 privacy mask zones		
	Record File Storage	NVR local/network and etc.		
	Backup Mode	Peripheral USB device		
Port and Indicator	Network Protocol	IPv4, IPv6, HTTP, NTP, DNS, ONVIF		
	SATA Port	1		
	eSATA Port	N/A		
	RS232 Port	N/A		
	RS485 Port	N/A		

Model		21-4KS2 Series	21-P-4KS2 Series	21-8P-4KS2 Series
	USB Port	2 peripheral USB2.0 ports.		
	HDMI Port	1		
	Network Connection	1 RJ45 10/100Mbps self-adaptive Ethernet port.		1 RJ45 10/100/1000Mbps self-adaptive Ethernet port.
	PoE	N/A	4	8
	Power Button	One at the rear panel.		
	Power On-off Button	N/A		
	IR Receiver Window	N/A		
	Clock	Built-in real-time clock.		
	Indicator Light	One power status indicator light. One network status indicator light. One HDD status indicator light.		
	General	Power Supplying	DC12V 1.5A	DC48V 1.25A
Power Consumption		<10W (No HDD, no PoE connection)		
Working Temperature		- 10℃ ~ + 50℃		
Working Humidity		10%~90%		
Air pressure		86kPa~106kPa		
Dimension		205mm×205mm×52mm		425mm×260mm×95mm

Model		21-4KS2 Series	21-P-4KS2 Series	21-8P-4KS2 Series
	Weight	0.9kg~1.0kg (No HDD)		
	Installation Mode	Desk installation		

1.3.27 NVR21HS-4KS2/21HS-P-4KS2/21HS-8P-4KS2 Series

Model		21HS-4KS2 Series	21HS-P-4KS2 Series	21HS-8P-4KS2 Series
System	System Resources	4/8/16-ch series product support 4/8/16 HD connection respectively. Total bandwidth supports 80Mbps.	4-ch series product support 4 HD connection. Total bandwidth supports 80Mbps.	8-ch series product support 8 HD connection. Total bandwidth supports 80Mbps.
	OS	Embedded Linux operation system		
	Operation Interface	WEB/Local GUI		
Decode	Video Decode Type	H.264;H265;MPEG4		
	Decode Capability	Max 1-ch 4K, 1-ch 6M,1-ch 5M, 2-ch 4M, 4-ch 1080P or 8-ch 720P		
Video	Video Input	4/8/16-ch network compression video input	4-ch network compression video input	8-ch network compression video input
	Video Output	1-channel VGA analog video output 1-channel HDMI video output, HDMI version is 1.4. VGA and HDMI output the video from the same video source.		
	Video Compression	N/A		

Model		21HS-4KS2 Series	21HS-P-4KS2 Series	21HS-8P-4KS2 Series
	Standard			
	Window Split	1/4/8/9/16-window	1/4-window	1/4/8/9-window
Audio	Audio Input	1-ch bidirectional talk input		
	Audio Output	1-ch bidirectional talk output		
	Audio Compression Standard	PCM,G.711a,G711u		
Alarm	Alarm Input	N/A		
	Alarm Output	N/A		
Function	Record Mode	Manual record, motion detect record, schedule record, alarm record. The record priority: Manual record>Alarm record>Motion detect record>Schedule record		
	Multiple-Channel Playback	Max 4-channel 1080P playback		
	Motion Detect	Each video supports PAL 396(22*18)/ NTSC 330(22*15) detection zones, support multiple sensitivity levels.		
	Privacy Mask	Each channel supports 4 privacy mask zones		
	Record File Storage	NVR local/network and etc.		
	Backup Mode	Peripheral USB device		
Port and Indicator	Network Protocol	IPv4, IPv6, HTTP, NTP, DNS, ONVIF		
	SATA Port	1		
	eSATA Port	N/A		

Model		21HS-4KS2 Series	21HS-P-4KS2 Series	21HS-8P-4KS2 Series
	RS232 Port	N/A		
	RS485 Port	N/A		
	USB Port	2 peripheral USB2.0 ports.		
	HDMI Port	1		
	Network Connection	1 RJ45 10/100Mbps self-adaptive Ethernet port.	1 RJ45 10/100/1000Mbps self-adaptive Ethernet port.	
	PoE	N/A	4	8
	Power Button	One at the rear panel.		
	Power On-off Button	N/A		
	IR Receiver Window	N/A		
	Clock	Built-in real-time clock.		
Indicator Light	One power status indicator light. One network status indicator light. One HDD status indicator light.			
General	Power Supplying	DC12V 1.5A	DC48V 1.25A	DC48V 2A
	Power Consumption	<10W (No HDD, no PoE connection)		
	Working Temperature	- 10°C ~ + 50°C		
	Working Humidity	10%~90%		

Model		21HS-4KS2 Series	21HS-P-4KS2 Series	21HS-8P-4KS2 Series
	Air pressure	86kPa~106kPa		
	Dimension	260mm×224mm×47.6mm		
	Weight	0.9kg~1.0kg (No HDD)		
	Installation Mode	Desk installation		

1.3.28 NVR22-4KS2/21-P-4KS2/22-8P-4KS2 Series

Model		22-4KS2 Series	22-P-4KS2 Series	22-8P-4KS2 Series
System	System Resources	4/8/16-ch series product support 4/8/16 HD connection respectively. Total bandwidth supports 80Mbps.	4-ch series product support 4 HD connection. Total bandwidth supports 80Mbps.	8-ch series product support 8 HD connection. Total bandwidth supports 80Mbps.
	OS	Embedded Linux operation system		
	Operation Interface	WEB/Local GUI		
Decode	Video Decode Type	H.264;H265;MPEG4		
	Decode Capability	Max 1-ch 4K, 1-ch 6M,1-ch 5M, 2-ch 4M, 4-ch 1080P or 8-ch 720P		
Video	Video Input	4/8/16-ch network compression video input	4-ch network compression video input	8-ch network compression video input
	Video Output	1-channel VGA analog video output 1-channel HDMI video output, HDMI version is 1.4.		

Model		22-4KS2 Series	22-P-4KS2 Series	22-8P-4KS2 Series
		VGA and HDMI output the video from the same video source.		
	Video Compression Standard	N/A		
	Window Split	1/4/8/9/16-window	1/4-window	1/4/8/9-window
Audio	Audio Input	1-ch bidirectional talk input		
	Audio Output	1-ch bidirectional talk output		
	Audio Compression Standard	PCM,G.711a,G711u		
Alarm	Alarm Input	N/A		
	Alarm Output	N/A		
Function	Record Mode	Manual record, motion detect record, schedule record, alarm record. The record priority: Manual record>Alarm record>Motion detect record>Schedule record		
	Multiple-Channel Playback	Max 4-channel 1080P playback		
	Motion Detect	Each video supports PAL 396(22*18)/ NTSC 330(22x15) detection zones, support multiple sensitivity levels.		
	Privacy Mask	Each channel supports 4 privacy mask zones		
	Record File Storage	NVR local/network and etc.		
	Backup Mode	Peripheral USB device		
Port and Indicator	Network Protocol	IPv4, IPv6, HTTP, NTP, DNS, ONVIF		
	SATA Port	2		

Model		22-4KS2 Series	22-P-4KS2 Series	22-8P-4KS2 Series
	eSATA Port	N/A		
	RS232 Port	N/A		
	RS485 Port	N/A		
	USB Port	2 peripheral USB2.0 ports.		
	HDMI Port	1		
	Network Connection	1 RJ45 10/100Mbps self-adaptive Ethernet port.	1 RJ45 10/100/1000Mbps self-adaptive Ethernet port.	
	PoE	N/A	4	8
	Power Button	One at the rear panel.		
	Power On-off Button	N/A		
	IR Receiver Window	N/A		
	Clock	Built-in real-time clock.		
	Indicator Light	One power status indicator light. One network status indicator light. One HDD status indicator light.		
	General	Power Supplying	DC12V 4A	DC48V 1.5A
General	Power Consumption	<10W (No HDD, no PoE connection)		
	Working Temperature	- 10°C ~ + 50°C		
	Working Humidity	10%~90%		

Model		22-4KS2 Series	22-P-4KS2 Series	22-8P-4KS2 Series
	Air pressure	86kPa~106kPa		
	Dimension	375mm×278.6mm×56mm		
	Weight	1.5kg~2.5kg (No HDD)		
	Installation Mode	Desk installation		

1.3.29 NVR52-16P-4KS2E Series

Specifications		NVR52-16P-4KS2E Series
System	Main Processor	Industrial embedded micro processor
	Operation System	Embedded LINUX system
	System Resources	16/32-channel main stream connection: max supports 160/320Mbps
	User Interface	WEB, local GUI
Audio Parameters	Audio Input	1-ch MIC bidirectional talk audio input
	Audio Output	1-ch MIC bidirectional talk audio output
	Audio Compression Standard	G.711a, G.711u, PCM, G.726 (The bidirectional talk supports G.711a, G.711u, PCM only.)
Video Parameters	Video Input	16/32-ch network compression video input
	Video Output	1-channel VGA 1-channel HDMI.
	Video Compression Standard	H.264
	Window Split Mode	1/4/8/9/16/25/36-screen.
Alarm Parameters	Alarm Input	4-channel
	Alarm Output	2-channel relay output
Decode Parameters	Decode Type	MPEG4, MJPEG, H.264, H.265
	Decode Capability	H.264/H.265: 64-channel×D1, 32-channel×720P, 16-channel 1080P; 4-channel 4K.
Functions	Record Mode	Manual recording, motion detection recording, schedule recording and alarm recording. Priority: Manual recording>card number recording-> alarm recording>motion detection recording>schedule recording.
	Multi-Channel Playback	Max support 16-channel 1080P playback at the same time.

	Motion Detect	Each screen supports 396/330((PAL 22×18, NTSC 22×15) detection zones. Various sensitivity levels.
	Privacy Mask	Each channel supports 4 privacy mask zones.
	Record Mode	Overwrite
	Backup Mode	Flash disk, DVD burner.
Network Function	Network Protocol	IPv4/IPv6/HTTP/UPnP/NTP/SADP/SNMP/PPPoE/DNS/FTP/ONVIF(Version 2.4)
	SATA Port	2 SATA Ports
	eSATA Port	N/A
	RS232 Port	1 RS232 port. To debug and transmit COM data.
	RS485 Port	1 RS485 port. To control peripheral PTZ and etc. Support various protocols.
	USB Port	1 USB 2.0 port at the front panel and 1 USB3.0 port at the rear panel.
	HDMI Port	1 HDMI port
	Network Port	1 RJ45 10/100/1000Mbps self-adaptive Ethernet ports
	PoE Port	16 PoE ports: Port 1 to port 8 support ePoE function (300 meters@100Mbps, 800 meters@10Mbps). Port 9 to port 16 are general PoE ports.
	Power Port	One power socket. Power adapter power supplying. Input AC 100V~240V, 50Hz~60Hz.
	Power On-off Button	One at the rear panel.
	Fan	Adjustable fan speed
		Indicator Light
General Parameters	Power Consumption	15.5W (No HDD)
	Working Temperature	-10℃~55℃
	Working Humidity	10%~90% (No condensation)
	Dimensions (W×H×D)	375mm×327.3mm×53mm (Including cushion)
	Weight(No HDD)	2.7Kg (No HDD)
	Installation Mode	Rack/desktop

1.3.30 NVR54-16P-4KS2E Series

Specifications		NVR54-16P-4KS2E Series
System	Main Processor	Industrial embedded micro processor

	Operation System	Embedded LINUX system
	System Resources	16/32/64-channel main stream connection: max supports 160/320/320Mbps
	User Interface	WEB, local GUI
Audio Parameters	Audio Input	1-ch MIC bidirectional talk audio input
	Audio Output	2-ch MIC bidirectional talk audio output
	Audio Compression Standard	G.711a, G.711u, PCM, G.726 (The bidirectional talk supports G.711a, G.711u, PCM only.)
Video Parameters	Video Input	16/32/64-ch network compression video input
	Video Output	2-channel VGA 2-channel HDMI.
	Video Compression Standard	H.264
	Window Split Mode	1/4/8/9/16/25/36/64-screen.
Alarm Parameters	Alarm Input	16-channel
	Alarm Output	6-channel relay output including one 12V DC output.
Decode Parameters	Decode Type	MPEG4, MJPEG, H.264, H.265
	Decode Capability	H.264/H.265: 64-channelxD1, 32-channelx720P, 16-channel 1080P; 4-channel 4K.
Functions	Record Mode	Manual recording, motion detection recording, schedule recording and alarm recording. Priority: Manual recording>card number recording-> alarm recording>motion detection recording>schedule recording.
	Multi-Channel Playback	Max support 16-channel 1080P playback at the same time.
	Motion Detect	Each screen supports 396/330((PAL 22x18, NTSC 22x15) detection zones. Various sensitivity levels.
	Privacy Mask	Each channel supports 4 privacy mask zones.
	Record Mode	Overwrite
	Backup Mode	Flash disk, eSATA, DVD burner.
Network Function	Network Protocol	IPv4/IPv6/HTTP/UPnP/NTP/SADP/SNMP/PPPoE/DNS/FTP/ONVIF(Version 2.4)
	SATA Port	4 SATA Ports
	eSATA Port	1 port
	RS232 Port	1 RS232 port. To debug and transmit COM data.
	RS485 Port	1 RS485 port. To control peripheral PTZ and etc. Support various protocols.
	USB Port	1 USB 2.0 port at the front panel and 2 USB3.0 ports at the rear panel.

	HDMI Port	2 HDMI ports
	Network Port	1 RJ45 10/100/1000Mbps self-adaptive Ethernet ports
	PoE Port	16 PoE ports: Port 1 to port 8 support ePoE function (300 meters@100Mbps, 800 meters@10Mbps). Port 9 to port 16 are general PoE ports.
	Power Port	One power socket. Power adapter power supplying. Input AC 100V~240V, 50Hz~60Hz.
	Power On-off Button	One at the rear panel.
	Fan	Adjustable fan speed
	Indicator Light	4 indicator lights. <ul style="list-style-type: none"> ● 1 system running status indicator light ● 1 HDD indicator light ● 1 network status indicator light ● 1 power status indicator light
General Parameters	Power Consumption	17.5W (No HDD)
	Working Temperature	-10℃~55℃
	Working Humidity	10%~90% (No condensation)
	Dimensions (W×H×D)	440mm×411mm×76mm (Including cushion)
	Weight(No HDD)	4.65Kg (No HDD)
	Installation Mode	Rack/desktop

1.3.31 NVR58-16P-4KS2E Series

Specifications		NVR58-16P-4KS2E Series
System	Main Processor	Industrial embedded micro processor
	Operation System	Embedded LINUX system
	System Resources	16/32/64-channel main stream connection: max supports 160/320/320Mbps
	User Interface	WEB, local GUI
Audio Parameters	Audio Input	1-ch MIC bidirectional talk audio input
	Audio Output	2-ch MIC bidirectional talk audio output
	Audio Compression Standard	G.711a, G.711u, PCM, G.726 (The bidirectional talk supports G.711a, G.711u, PCM only.)

Video Parameters	Video Input	16/32/64-ch network compression video input
	Video Output	2-channel VGA 2-channel HDMI.
	Video Compression Standard	H.264
	Window Split Mode	1/4/8/9/16/25/36/64-screen.
Alarm Parameters	Alarm Input	16-channel
	Alarm Output	6-channel relay output including one 12V DC output.
Decode Parameters	Decode Type	MPEG4, MJPEG, H.264, H.265
	Decode Capability	H.264/H.265: 64-channel×D1, 32-channel×720P, 16-channel 1080P; 4-channel 4K.
Functions	Record Mode	Manual recording, motion detection recording, schedule recording and alarm recording. Priority: Manual recording>card number recording-> alarm recording>motion detection recording>schedule recording.
	Multi-Channel Playback	Max support 16-channel 1080P playback at the same time.
	Motion Detect	Each screen supports 396/330((PAL 22×18, NTSC 22×15) detection zones. Various sensitivity levels.
	Privacy Mask	Each channel supports 4 privacy mask zones.
	Record Mode	Overwrite
	Backup Mode	Flash disk, eSATA, DVD burner.
Network Function	Network Protocol	IPv4/IPv6/HTTP/UPnP/NTP/SADP/SNMP/PPPoE/DNS/FTP/ONVIF(Version 2.4)
	SATA Port	8 SATA Ports
	eSATA Port	1 port
	RS232 Port	1 RS232 port. To debug and transmit COM data.
	RS485 Port	1 RS485 port. To control peripheral PTZ and etc. Support various protocols.
	USB Port	2 USB 2.0 ports at the front panel and 2 USB3.0 ports at the rear panel.
	HDMI Port	2 HDMI ports
	Network Port	1 RJ45 10/100/1000Mbps self-adaptive Ethernet ports
	PoE Port	16 PoE ports: Port 1 to port 8 support ePoE function (300 meters@100Mbps, 800 meters@10Mbps). Port 9 to port 16 are general PoE ports.
	Power Port	One power socket. Power adapter power supplying. Input AC 100V~240V, 50Hz~60Hz.
	Power On-off Button	One at the rear panel.
	Fan	Adjustable fan speed

	Indicator Light	4 indicator lights. <ul style="list-style-type: none"> ● 1 system running status indicator light ● 1 HDD indicator light ● 1 network status indicator light ● 1 power status indicator light
General Parameters	Power Consumption	17.5W (No HDD)
	Working Temperature	-10°C~55°C
	Working Humidity	10%~90% (No condensation)
	Dimensions (W×H×D)	439.7mm×450.8mm×95mm (Including cushion)
	Weight(No HDD)	7.0Kg (No HDD)
	Installation Mode	Rack/desktop

2 Front Panel and Rear Panel

2.1 Front Panel

2.1.1 NVR41/41-P/41-W/21-S2/21-P-S2/21-8P-S2/41-4KS2/41-P-4KS2/41-8P-4KS2/1A-4P/1A-8P/21-4KS2/21-P-4KS2/21-8P-4KS2 Series

The front panel is shown as in Figure 2-1.

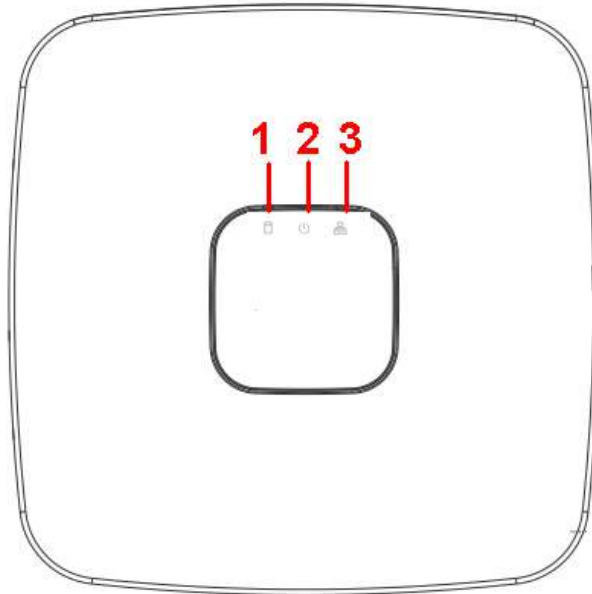

Figure 2-1

Please refer to the following sheet for detailed information.

SN	Name	Function
1	HDD status indicator light	The red light becomes on when HDD is abnormal.
2	Power indicator light	The red light becomes on when the power connection is OK.
3	Network status indicator light	The red light becomes on when the network connection is abnormal.

2.1.2 NVR41H/41H-P/41H-8P Series

The front panel is shown as in Figure 2-2.

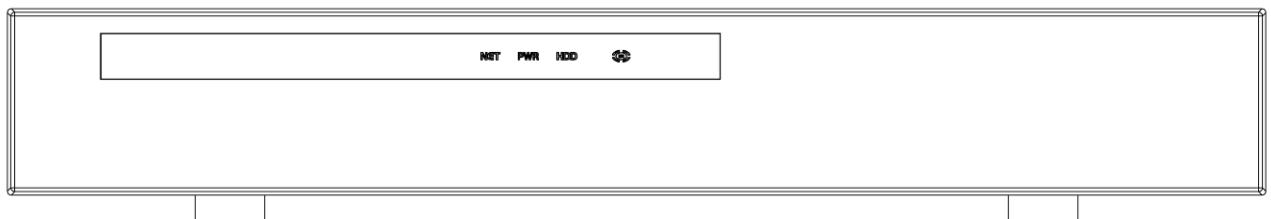

Figure 2-2

Please refer to the following sheet for detailed information.

Icon	Name	Function
NET	Network status indicator light	The red light becomes on when the network connection is abnormal.
PWR	Power indicator light	The red light becomes on when the power connection is OK.
HDD	HDD status indicator light	The red light becomes on when HDD is abnormal.
IR	Remote control receiver	It is to receive signal from the remote control.

2.1.3 NVR41HS-W-S2 Series

The front panel is shown as below. See Figure 2-3.

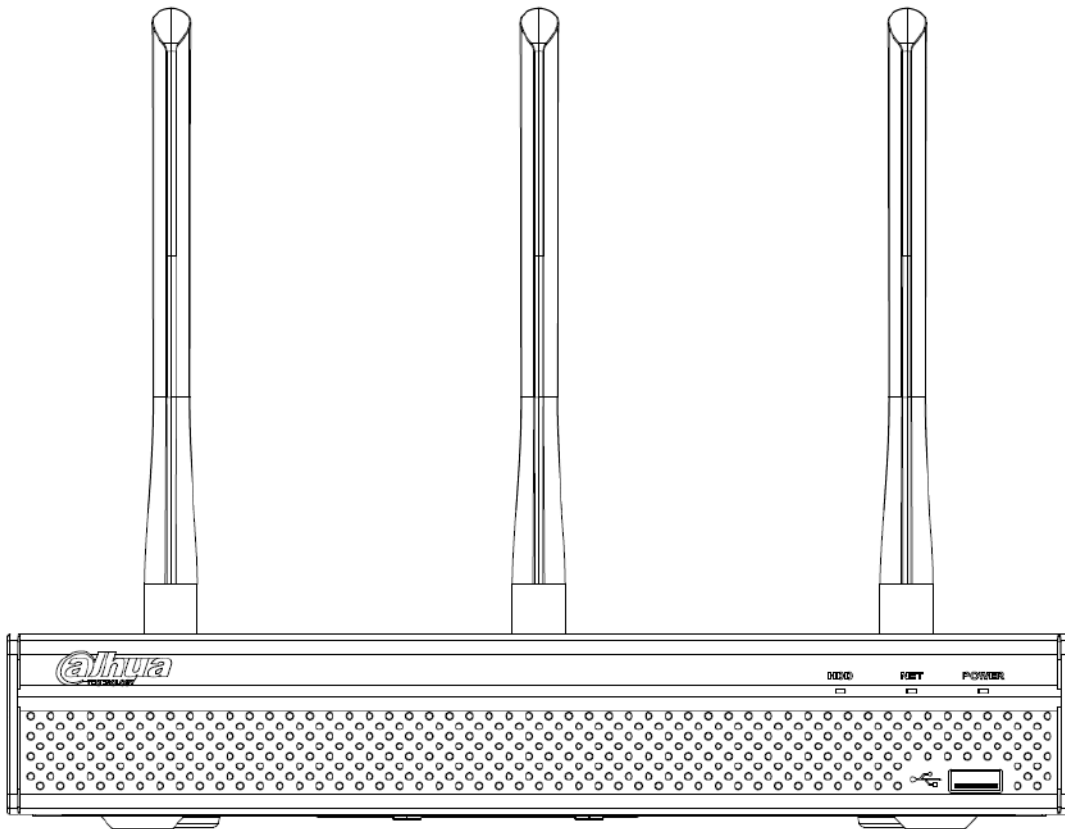



Figure 2-3

Please refer to the following sheet for front panel button information.

Icon	Name	Function
HDD	HDD status indicator light	The blue light is on when the HDD is malfunction.
NET	Network status indicator light	The blue light is on when the network connection is abnormal.
POWER	Power status indicator light	The blue light is on when the power connection is OK.
	USB2.0 port	Connect to peripheral USB 2.0 storage device, mouse, burner and etc.

2.1.4 NVR41-8P Series

The front panel is shown as below. See Figure 2-4.

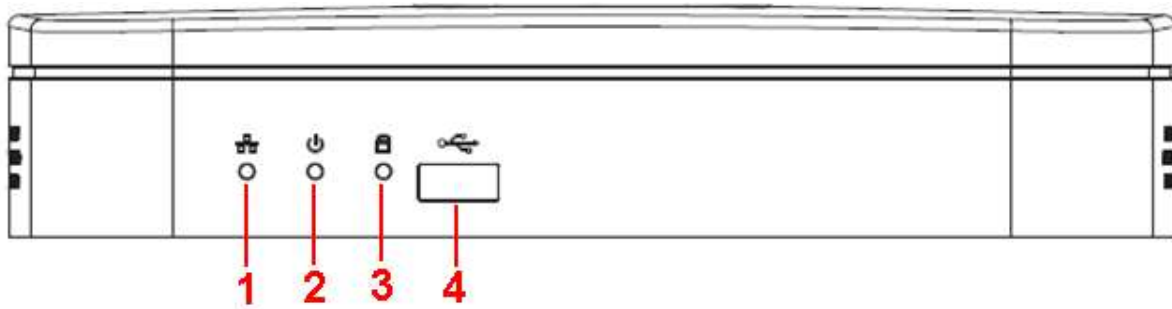

Figure 2-4

Please refer to the following sheet for detailed information.

SN	Name	Function
1	Network status indicator light	The red light becomes on when the network connection is abnormal.
2	Power indicator light	The red light becomes on when the power connection is OK.
3	HDD status indicator light	The red light becomes on when HDD is abnormal.
4	USB	USB port

2.1.5 NVR42/42-P/42-8P Series

The front panel is shown as below. See Figure 2-5.

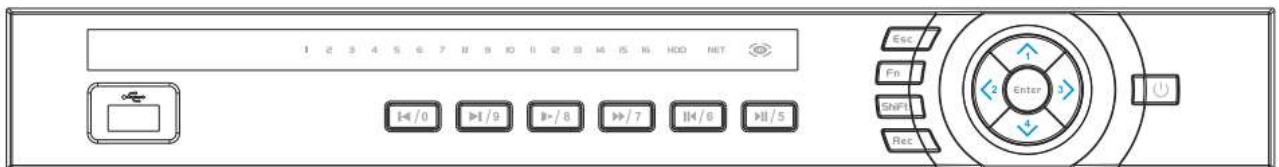











Figure 2-5

Please refer to the following sheet for front panel button information.

Name	Icon	Function
Power button		Power button, press this button for three seconds to boot up or shut down NVR.
Shift	Shift	In textbox, click this button to switch between numeral, English(Small/Capitalized),donation and etc.
Up/1 Down/4		Activate current control, modify setup, and then move up and down.
		Increase/decrease numeral.
		Assistant function such as PTZ menu.
		In text mode, input number 1/4 (English character G/H/I)

Left/2 Right/3	 	Shift current activated control,
		When playback, click these buttons to control playback bar. In text mode, input number 2(English character A/B/C) /3(English character D/E/F)
ESC	ESC	Go to previous menu, or cancel current operation.
		When playback, click it to restore real-time monitor mode.
Enter	ENTER	Confirm current operation
		Go to default button
		Go to menu
Record	REC	Manually stop/start recording, working with direction keys or numeral keys to select the recording channel.
Slow play/8		Multiple slow play speeds or normal playback. In text mode, input number 8 (English character T/U/V).
Assistant	Fn	One-window monitor mode, click this button to display assistant function: PTZ control and image color.
		Backspace function: in numeral control or text control, press it for 1.5seconds to delete the previous character before the cursor.
		In motion detection setup, working with Fn and direction keys to realize setup.
		In text mode, click it to switch between numeral, English character(small/capitalized) and etc.
		Realize other special functions.
Fast play/7		Various fast speeds and normal playback. In text mode, input number 7 (English character P/Q/R/S).
Play previous/0		In playback mode, playback the previous video In text mode, input number 0.
Reverse/Pause/6		In normal playback or pause mode, click this button to reverse playback In reverse playback, click this button to pause playback.
Play Next/9		In playback mode, playback the next video In menu setup, go to down ward of the dropdown list. In text mode, input number 9 (English character W/X/Y/Z)
Play/Pause /5		In normal playback click this button to pause playback In pause mode, click this button to resume playback. In text mode, input number 5(English character J/K/L).

USB port		To connect USB storage device, USB mouse.
Network abnormal indicator light	Net	Network error occurs or there is no network connection, the light becomes red to alert you.
HDD abnormal indicator light	HDD	HDD error occurs or HDD capacity is below specified threshold value, the light becomes red to alert you.
Record light	1-16	System is recording or not. It becomes on when system is recording.
IR Receiver	IR	It is to receive the signal from the remote control.

2.1.6 NVR21HS-S2/21HS-P-S2/21HS-8P-S2/41HS-4KS2/41HS-P-4KS2/41HS-8P-4KS2/1AHS/1A HS-4P/1AHS-8P/21HS-4KS2/21HS-P-4KS2/21HS-8P-4KS2 Series

The front panel is shown as below. See Figure 2-6.

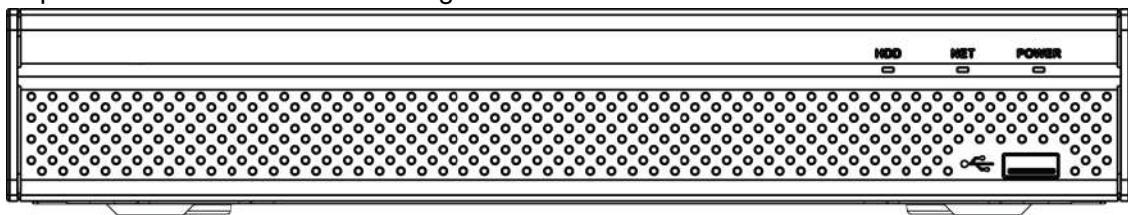



Figure 2-6

Please refer to the following sheet for front panel button information.

Icon	Name	Function
HDD	HDD status indicator light	The blue light is on when the HDD is malfunction.
NET	Network status indicator light	The blue light is on when the network connection is abnormal.
POWER	Power status indicator light	The blue light is on when the power connection is OK.
	USB port	Connect to peripheral USB storage device, mouse and etc.

2.1.7 NVR/22-S2/22-P-S2/22-8P-S2/42-16P/42N/52-4KS2/52-8P-4KS2/52-16P-4KS2/42-4KS2/42-P-4KS2/42-8P-4KS2/42-16P-4KS2/5224-24P-4KS2/54-4KS2/54-16P-4KS2/44-4KS2/44-16P-4KS2/5424-24P-4KS2/58-4KS2/S258-16P-4KS2/48-4KS2/48-16P-4KS2/2A16/22-4KS2-22-P-4KS2-22-8P-4KS2/52-16P-4KS2E/54-16P-4KS2E/58-16P-4KS2E Series

The

NVR22-S2/NVR22-P-S2/22-8P-S2/42-16P/42N/52-4KS2/52-8P-4KS2/52-16P-4KS2/42-4KS2/42-P-4KS2/42-8P-4KS2/42-16P-4KS2/5224-24P-4KS2/2A16/22-4KS2/22-P-4KS2/22-8P-4KS2/52-16P-4KS2E ser

ies front panel is shown as in Figure 2-7.

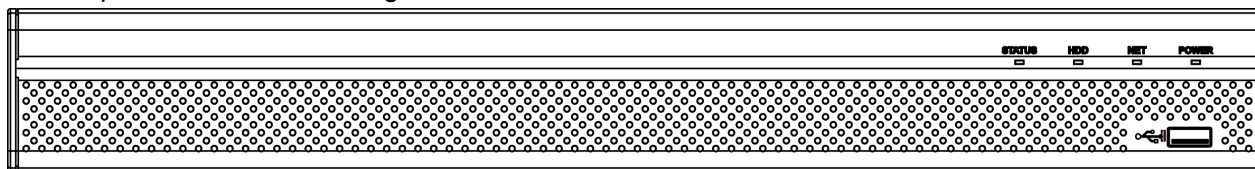

Figure 2-7

The NVR54-4KS2/54-16P-4KS2/44-4KS2/44-16P-4KS2/5424-24P-4KS2/54-16P-4KS2E series front panel is shown as in Figure 2-8.

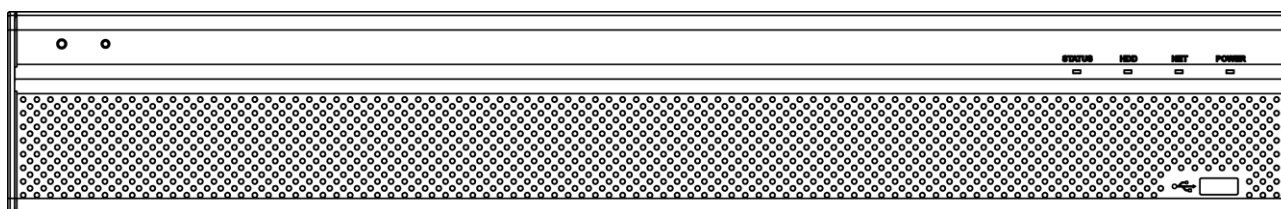

Figure 2-8

The NVR58-4KS2/58-16P-4KS2/48-4KS2/48-16P-4KS2/58-16P-4KS2E series front panel is shown as in Figure 2-9.

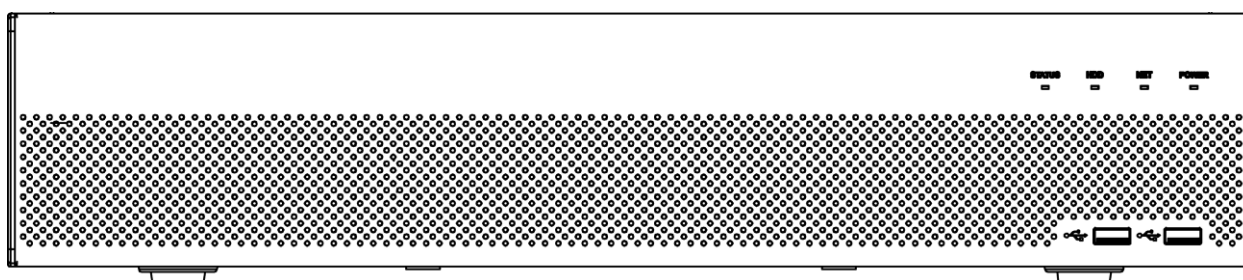



Figure 2-9

Please refer to the following sheet for front panel button information.

Icon	Name	Function
STATUS	Status indicator light	The blue light is on when the device is malfunction.
HDD	HDD status indicator light	The blue light is on when the HDD is malfunction.
NET	Network status indicator light	The blue light is on when the network connection is abnormal.
POWER	Power status indicator light	The blue light is on when the power connection is OK.
	USB2.0 port	Connect to peripheral USB 2.0 storage device, mouse, burner and etc.

2.1.8 NVR44/44-8P/44-16P Series

The front panel is shown as in Figure 2-10.

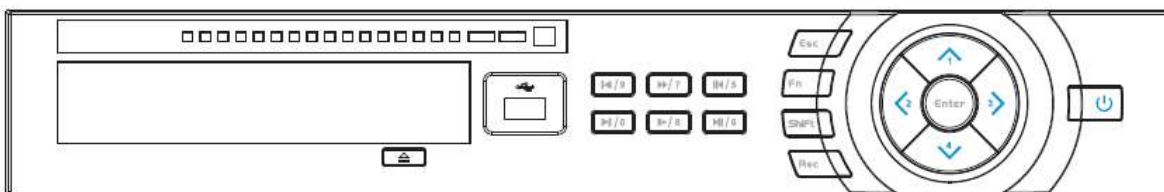



Figure 2-10

Please refer to the following sheet for front panel button information.

Name	Icon	Function
Power button		Power button, press this button for three seconds to boot up or shut down NVR.
Shift	Shift	In textbox, click this button to switch between numeral, English(Small/Capitalized),donation and etc.
Up/1 Down/4		Activate current control, modify setup, and then move up and down.
		Increase/decrease numeral.
		Assistant function such as PTZ menu.
		In text mode, input number 1/4 (English character G/H/I)
Left/2 Right/3		Shift current activated control,
		When playback, click these buttons to control playback bar. In text mode, input number 2(English character A/B/C) /3(English character D/E/F)
ESC	ESC	Go to previous menu, or cancel current operation.
		When playback, click it to restore real-time monitor mode.
Enter	ENTER	Confirm current operation
		Go to default button
		Go to menu
Record	REC	Manually stop/start recording, working with direction keys or numeral keys to select the recording channel.
Slow play/8		Multiple slow play speeds or normal playback. In text mode, input number 8 (English character T/U/V).
Assistant	Fn	One-window monitor mode, click this button to display assistant function: PTZ control and image color.
		Backspace function: in numeral control or text control, press it for 1.5seconds to delete the previous character before the cursor.
		In motion detection setup, working with Fn and direction keys to realize setup.

		In text mode, click it to switch between numeral, English character(small/capitalized) and etc. Realize other special functions.
Fast play/7	▶▶	Various fast speeds and normal playback. In text mode, input number 7 (English character P/Q/R/S).
Play previous/0	◀	In playback mode, playback the previous video In text mode, input number 0.
Reverse/Pause/6	◀	In normal playback or pause mode, click this button to reverse playback In reverse playback, click this button to pause playback.
Play Next/9	▶	In playback mode, playback the next video In menu setup, go to down ward of the dropdown list. In text mode, input number 9 (English character W/X/Y/Z)
Play/Pause /5	▶	In normal playback click this button to pause playback In pause mode, click this button to resume playback. In text mode, input number 5(English character J/K/L).
USB port		To connect USB storage device, USB mouse.
Network abnormal indicator light	Net	Network error occurs or there is no network connection, the light becomes red to alert you.
HDD abnormal indicator light	HDD	HDD error occurs or HDD capacity is below specified threshold value, the light becomes red to alert you.
Record light	1-16	System is recording or not. It becomes on when system is recording.

2.1.9 NVR48/48-16P Series

The Front panel is shown as follows. See Figure 2-11.

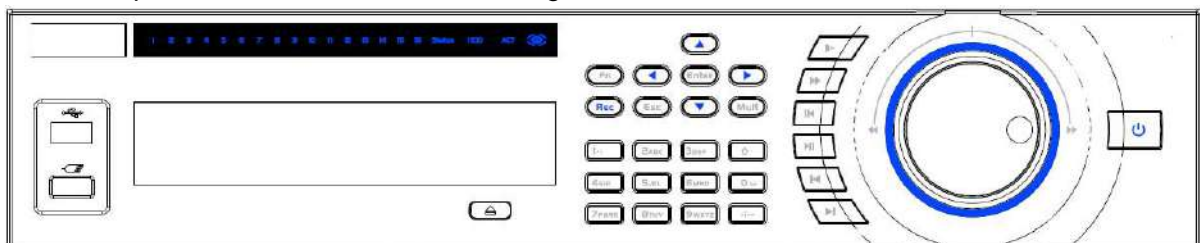







Figure 2-11

Please refer to the following sheet for front panel button information.

Name	Icon	Function
------	------	----------

Power button		Power button, press this button for three seconds to boot up or shut down NVR.
Number button	0-9	Input Arabic number Switch channel
Input number more than 10	-/--	If you want to input a number more than 10, please click this button and then input.
Shift		In textbox, click this button to switch between numeral, English(Small/Capitalized),donation and etc.
		Enable or disable tour.
Up/ Down		Activate current control, modify setup, and then move up and down.
		Increase/decrease numeral.
		Assistant function such as PTZ menu.
Left/ Right		Shift current activated control, and then move left and right.
		When playback, click these buttons to control playback bar.
ESC	ESC	Go to previous menu, or cancel current operation.
		When playback, click it to restore real-time monitor mode.
Enter	ENTER	Confirm current operation
		Go to default button
		Go to menu
Record	REC	Manually stop/start recording, working with direction keys or numeral keys to select the recording channel.
Slow play		Multiple slow play speeds or normal playback.
Assistant	Fn	One-window monitor mode, click this button to display assistant function: PTZ control and image color.
		Backspace function: in numeral control or text control, press it for 1.5seconds to delete the previous character before the cursor.
		In motion detection setup, working with Fn and direction keys to realize setup.
		In text mode, click it to switch between numeral, English character(small/capitalized) and etc.
		In HDD management interface, you can click it to switch HDD record information and other information (Menu prompt)
		Realize other special functions.

Fast play	▶▶	Various fast speeds and normal playback.
Play previous	◀	In playback mode, playback the previous video
Reverse/Pause	◀	In normal playback or pause mode, click this button to reverse playback In reverse playback, click this button to pause playback.
Play Next	▶	In playback mode, playback the next video In menu setup, go to down ward of the dropdown list.
Play/Pause	▶	In normal playback click this button to pause playback In pause mode, click this button to resume playback.
Window switch	Mult	Click it to switch one-window/multiple-window.
Shuttle(outer ring)		In real-time monitor mode it works as left/right direction key. Playback mode, counter clockwise to forward and clock wise to backward.
Jog(inner dial)		Up/down direction key. Playback mode, turn the inner dial to realized frame by frame playback. (Only applies to some special versions.)
USB port		To connect USB storage device, USB mouse.
Remote control indicator light	ACT	Remote control indicator light
Status indicator light	Status	If there is Fn indicator light, current status indicator light is null.
Power indicator light	PWR	Power indicator light
Channel indicator light	1-32	For 4/8/16-channel series product. The corresponding channel light becomes on when system is recording. For 32/64-channel series product: When the light flashes slowly, it means the corresponding channel of 1-16 channel is recording now (Such as channel 1). When the light flashes fast, it means the corresponding channel of 17-32 channel is recording now (Such as channel 17) When the light becomes on, It means the corresponding 2 channels are recording now (Such as channel 1 and channel 17.).
IR Receiver	IR	It is to receive the signal from the remote control.

2.1.10 NVR42V-8P Series

The front panel is shown as below. See Figure 2-12

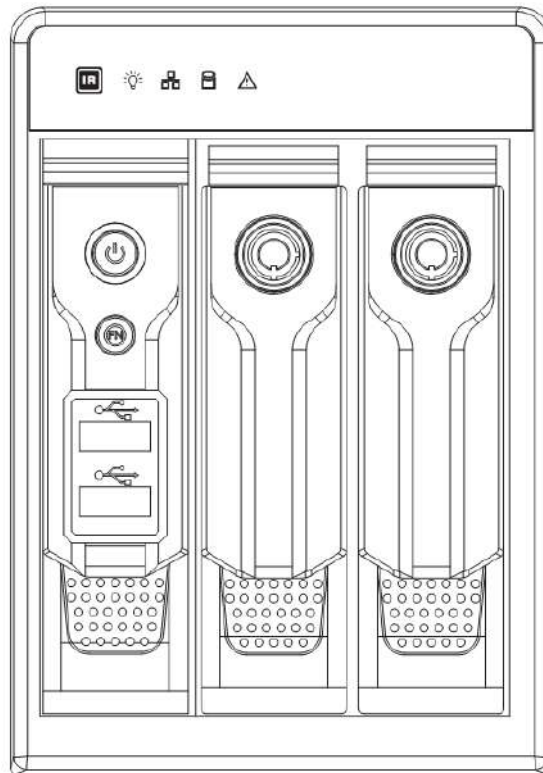









Figure 2-12

Please refer to the following sheet for front panel button information.

Name	Icon	Function
Power button		Power button, press this button for three seconds to boot up or shut down NVR.
Assistant	Fn	<ul style="list-style-type: none"> ● One-window monitor mode, click this button to display assistant function: PTZ control and image color. ● Backspace function: in numeral control or text control, press it for 1.5 seconds to delete the previous character before the cursor. ● In motion detection setup, working with Fn and direction keys to realize setup. ● In text mode, click it to switch between numeral, English character (small/capitalized) and etc. ● In HDD management interface, you can click it to switch HDD record information and other information (Menu prompt) ● Realize other special functions.
USB2.0 port		To connect USB2.0 storage device, USB2.0 mouse, burner and etc.
IR receive window		It is to receive the IR signal from the remote control.

Power indicator light		Power indicator light.
HDD abnormal indicator light		HDD error occurs or HDD capacity is below specified threshold value, the light becomes red to alert you.
Network abnormal indicator light		Network error occurs or there is no network connection, the light becomes red to alert you.
Alarm indicator light		The light becomes on when an alarm occurred.

2.2 Rear Panel

2.2.1 NVR41/41-P/41-8P/41-W Series

The NVR41 rear panel is shown as below. See Figure 2-13.

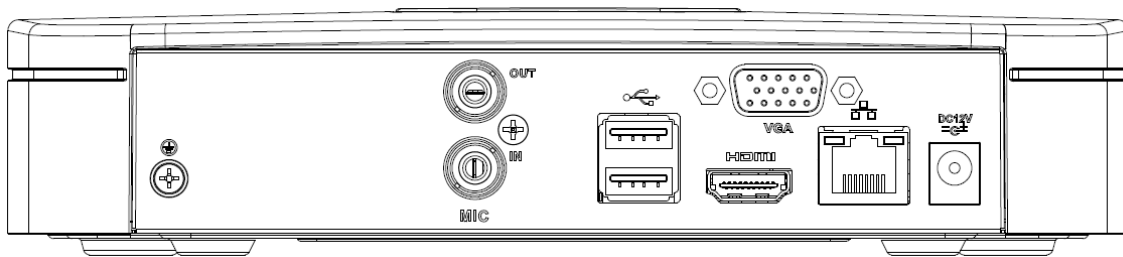

Figure 2-13

The NVR41-P rear panel is shown as below. See Figure 2-14.

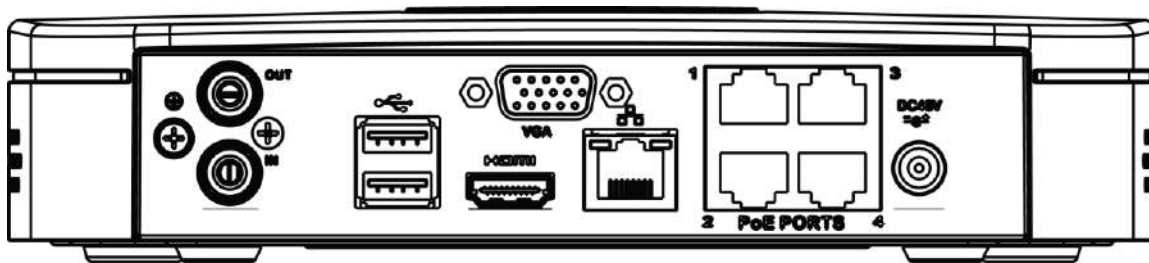

Figure 2-14

The NVR41-8P rear panel is shown as below. See Figure 2-15.

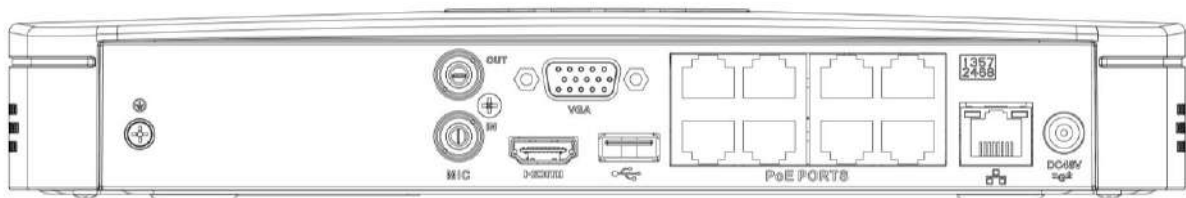

Figure 2-15

The NVR41-W rear panel is shown as below. See Figure 2-16.

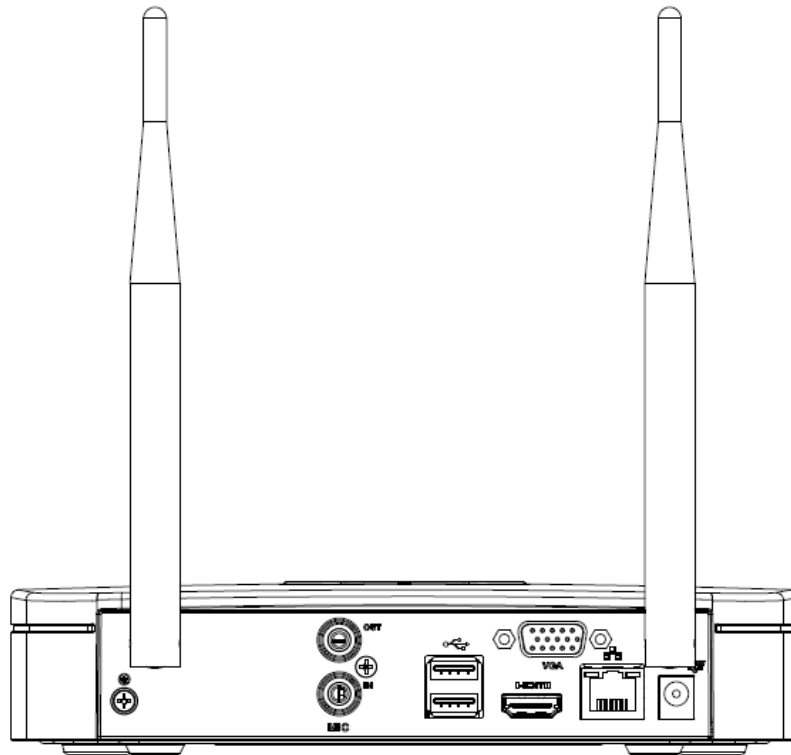



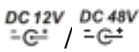

Figure 2-16

Please refer to the following sheet for detailed information.

Port Name	Connection	Function
	USB2.0 port	USB2.0 port. Connect to mouse, USB storage device, USB burner and etc.
	Network port	10M/100Mbps self-adaptive Ethernet port. Connect to the network cable.
HDMI	High Definition Media Interface	High definition audio and video signal output port. It transmits uncompressed high definition video and multiple-channel data to the HDMI port of the display device. HDMI version is 1.4.
VGA	VGA video output port	VGA video output port. Output analog video signal. It can connect to the monitor to view analog video.
	GND	Ground end
	Power input port	Power socket. <ul style="list-style-type: none"> ● For NVR41 series, input DC 12V/2A. ● For NVR41-P series, input DC 48V/1.5A. ● For NVR41-8P series, input DC 48V/2A.
MIC IN	Audio input port	Bidirectional talk input port. It is to receive the analog audio signal output from the devices such as microphone, pickup.

Port Name	Connection	Function
MIC OUT	Audio output port	Audio output port. It is to output the analog audio signal to the devices such as the sound box. <ul style="list-style-type: none"> ● Bidirectional talk output. ● Audio output on 1-window video monitor. ● Audio output on 1-window video playback.
PoE PORT	PoE port	Built-in switch. Support PoE function. For PoE series product, you can use this port to provide power to the network camera.
Wireless AP		Support wireless hotspot function. Use WIFI to connect to the network camera when there is a hotspot. For 41-W series only.

2.2.2 NVR21-S2/21-P-S2/21-8P-S2/1A-4P/1A-8P/21-4KS2/21-P-4KS2/21-8P-4KS2 Series

The NVR21-S2/21-4KS2 is shown as in Figure 2-17.

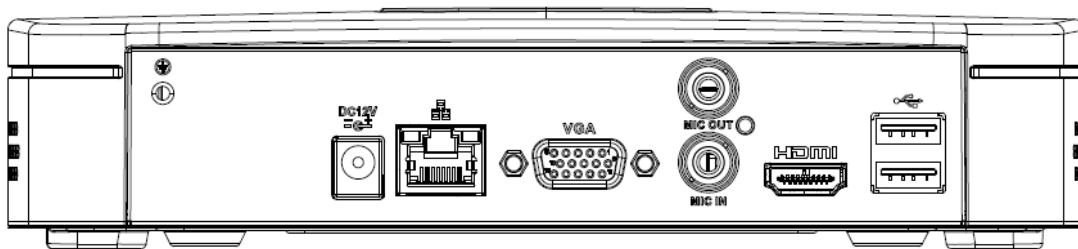

Figure 2-17

The NVR21-P-S2/1A-4P/21-P-4KS2 is shown as in Figure 2-18.

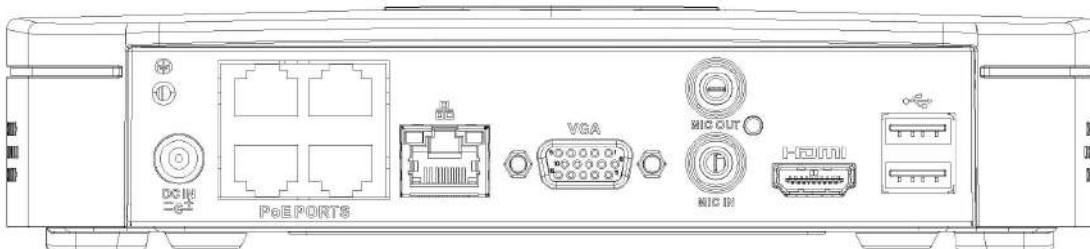

Figure 2-18

The NVR21-8P-S2/1A-8P/21-8P-4KS2 is shown as in Figure 2-19.

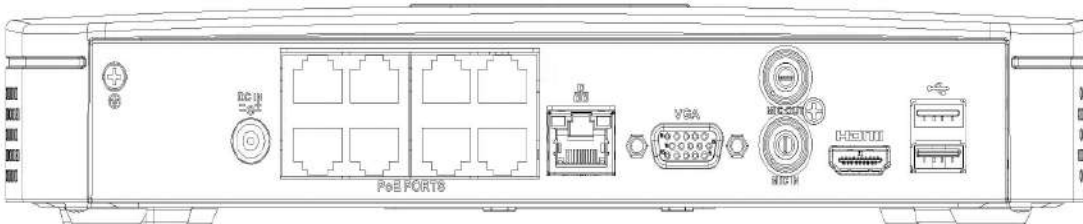





Figure 2-19

Please refer to the following sheet for detailed information.

Port Name	Connection	Function
DC 12V	Power input port	Power socket <ul style="list-style-type: none"> For NVR21-S2/21-4KS2, input DC 12V/2A. For NVR21-P-S2/1A-4P/21-P-4KS2, input DC 48V/1.25A. For NVR21-8P-S2/1A-8P/21-8P-4KS2, input DC 48V/2A.
	Network port	10M/100Mbps self-adaptive Ethernet port. Connect to the network cable.
	USB port	USB port. Connect to mouse, USB storage device and etc.
HDMI	High Definition Media Interface	High definition audio and video signal output port. It transmits uncompressed high definition video and multiple-channel data to the HDMI port of the display device. HDMI version is 1.4.
VGA	VGA video output port	VGA video output port. Output analog video signal. It can connect to the monitor to view analog video.
MIC IN	Audio input port	Bidirectional talk input port. It is to receive the analog audio signal output from the devices such as microphone, pickup.
MIC OUT	Audio output port	Audio output port. It is to output the analog audio signal to the devices such as the sound box. <ul style="list-style-type: none"> Bidirectional talk output. Audio output on 1-window video monitor. Audio output on 1-window video playback.
	GND	Ground end
PoE PORTS	PoE port	Built-in switch. Support PoE function. For PoE series product, you can use this port to provide power to the network camera.

2.2.3 NVR41H/41H-P/41H-8P Series

The NVR41H rear panel is shown as in Figure 2-20.

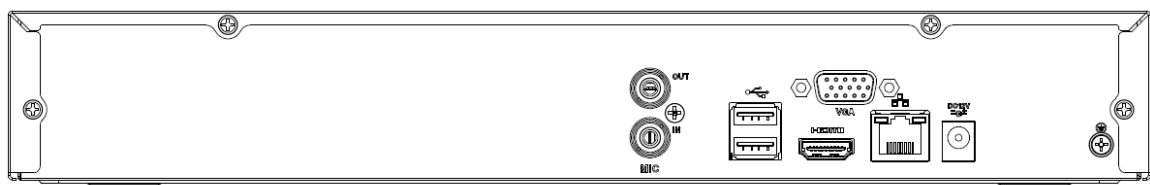

Figure 2-20

The NVR41H-P rear panel is shown as in Figure 2-21.

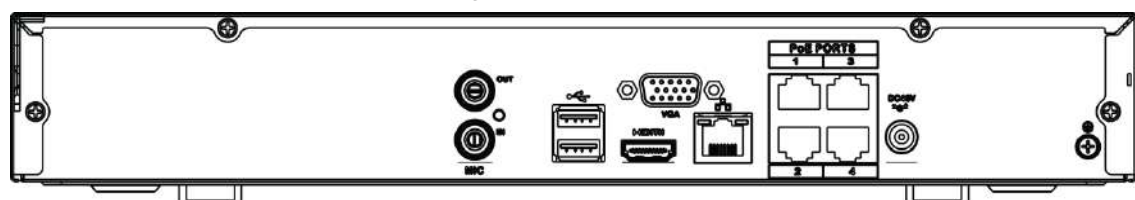

Figure 2-21

The NVR41H-8P rear panel is shown as in Figure 2-22.

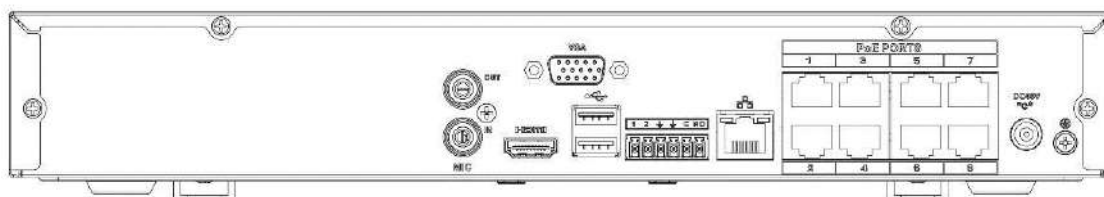



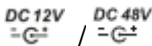

Figure 2-22

Please refer to the following sheet for detailed information.

Port Name	Connection	Function
	USB2.0 port	USB2.0 port. Connect to mouse, USB storage device, USB burner and etc.
	Network port	10M/100Mbps self-adaptive Ethernet port. Connect to the network cable.
HDMI	High Definition Media Interface	High definition audio and video signal output port. It transmits uncompressed high definition video and multiple-channel data to the HDMI port of the display device. HDMI version is 1.4.
VGA	VGA video output port	VGA video output port. Output analog video signal. It can connect to the monitor to view analog video.
	GND	Ground end
	Power input port	Power socket. <ul style="list-style-type: none"> ● For NVR41 series, input DC 12V/2A. ● For NVR41H-P series, input DC 48V/1.5A. ● For NVR41H-8P series, input DC 48V/2A.
MIC IN	Audio input port	Bidirectional talk input port. It is to receive the analog audio signal output from the devices such as microphone, pickup.
MIC OUT	Audio output port	Audio output port. It is to output the analog audio signal to the devices such as the sound box. <ul style="list-style-type: none"> ● Bidirectional talk output. ● Audio output on 1-window video monitor. ● Audio output on 1-window video playback.
PoE PORT	PoE port	Built-in switch. Support PoE function. For PoE series product, you can use this port to provide power to the network camera.

2.2.4 NVR21HS-S2/21HS-P-S2/21HS-8P-S2/1AHS/1AHS-4P/1AHS-8P/21HS-4KS2/21HS-S-P-4KS2/21HS-8P-4KS2 Series

The NVR21HS-S2/1AHS/21HS-4KS2 series rear panel is shown as below. See Figure 2-23.

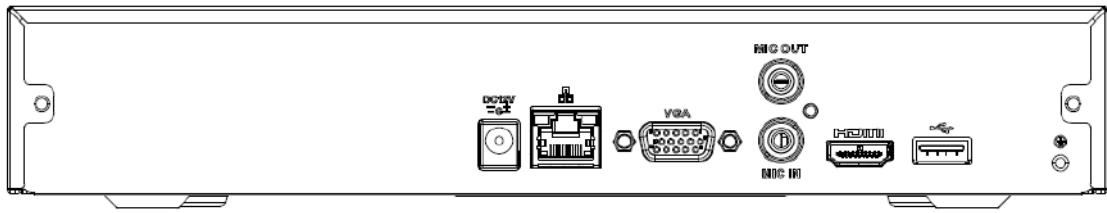

Figure 2-23

The NVR21HS-P-S2/1AHS-4P/21HS-P-4KS2 series rear panel is shown as below. See Figure 2-24.

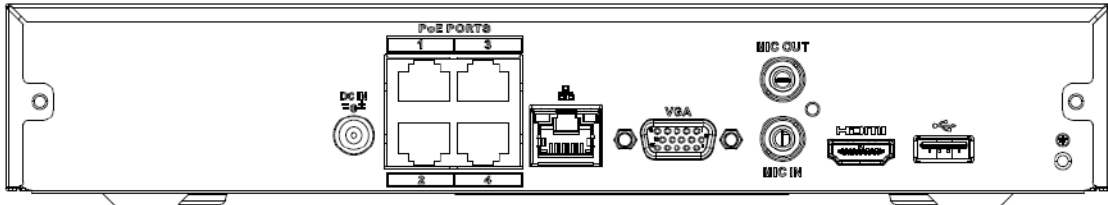



Figure 2-24

The NVR21HS-8P-S2/1AHS-8P/21HS-8P-4KS2 series rear panel is shown as below. See Figure 2-25.



Figure 2-25

Please refer to the following sheet for detailed information.

Port Name	Connection	Function
DC 12V	Power input port	Power socket. <ul style="list-style-type: none"> For NVR21HS-S2/1AHS/21HS-4KS2, input DC 12V/2A. For NVR21HS-P-S2/1AHS-4P/21HS-P-4KS2, input DC 48V/1.25A. For NVR21HS-8P-S2/1AHS-8P/21HS-8P-4KS2, input DC 48V/2A.
	Network port	10M/100Mbps self-adaptive Ethernet port. Connect to the network cable.
	USB port	USB port. Connect to mouse, USB storage device and etc.
HDMI	High Definition Media Interface	High definition audio and video signal output port. It transmits uncompressed high definition video and multiple-channel data to the HDMI port of the display device. HDMI version is 1.4.
VGA	VGA video output port	VGA video output port. Output analog video signal. It can connect to the monitor to view analog video.

Port Name	Connection	Function
MIC IN	Audio input port	Bidirectional talk input port. It is to receive the analog audio signal output from the devices such as microphone, pickup.
MIC OUT	Audio output port	Audio output port. It is to output the analog audio signal to the devices such as the sound box. <ul style="list-style-type: none"> ● Bidirectional talk output. ● Audio output on 1-window video monitor. ● Audio output on 1-window video playback.
	GND	Ground end
PoE PORTS	PoE port	Built-in switch. Support PoE function. For PoE series product, you can use this port to provide power to the network camera.

2.2.5 NVR41HS-W-S2 Series

The NVR41HS-W-S2 rear panel is shown as below. See Figure 2-26.

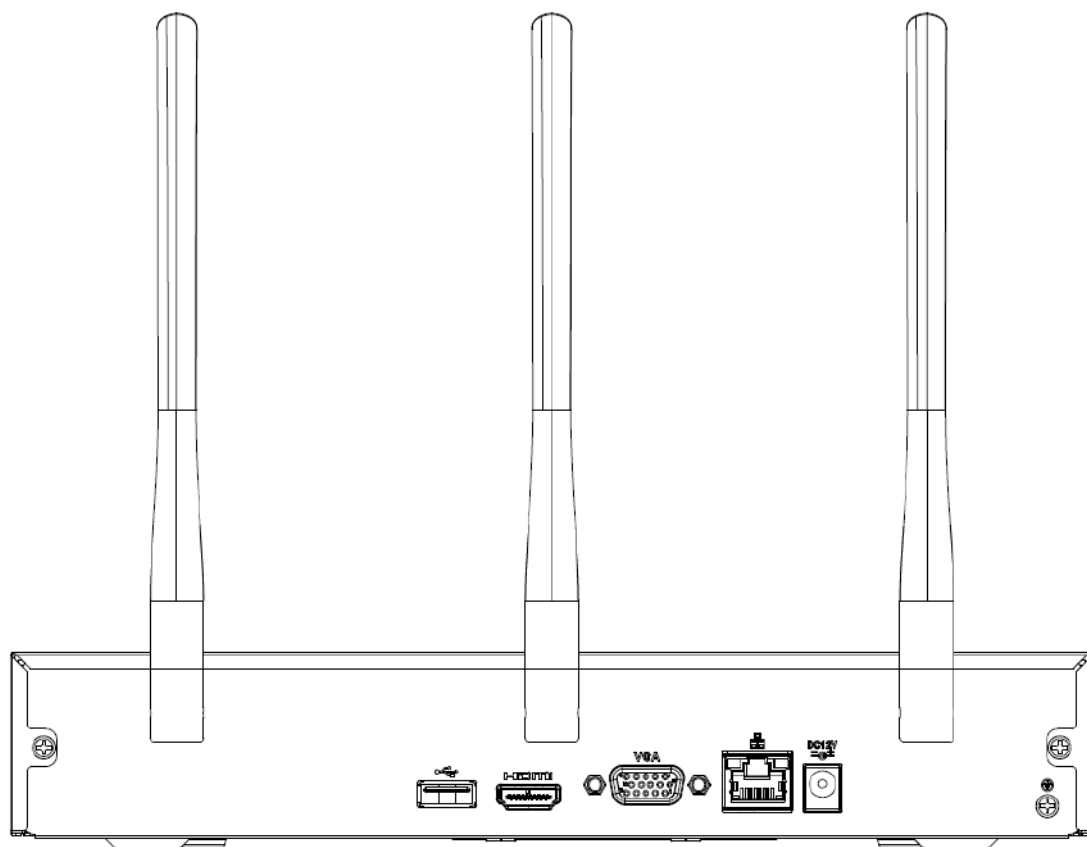





Figure 2-26

Please refer to the following sheet for detailed information.

Icon	Name	Function
	Power input socket.	Power socket. Input DC12V/2A.
	Network port	10M/100Mbps self-adaptive Ethernet port. Connect to the network cable.

Icon	Name	Function
	USB2.0 port	USB2.0 port. Connect to mouse, USB storage device, and etc.
HDMI	High Definition Media Interface	High definition audio and video signal output port. It transmits uncompressed high definition video and multiple-channel data to the HDMI port of the display device. HDMI version is 1.4.
VGA	VGA video output port	VGA video output port. Output analog video signal. It can connect to the monitor to view analog video.
	GND	Ground end
Wireless AP		Support wireless hotspot function. Use WIFI to connect to the network camera when there is a hotspot.

2.2.6 NVR22-S2/22-P-S2/22-8P-S2/2A16/22-4KS2/22-P-4KS2/22-8P-4KS2 Series

The NVR22-S2/2A16/22-4KS2 series rear panel is shown as below. See Figure 2-27.

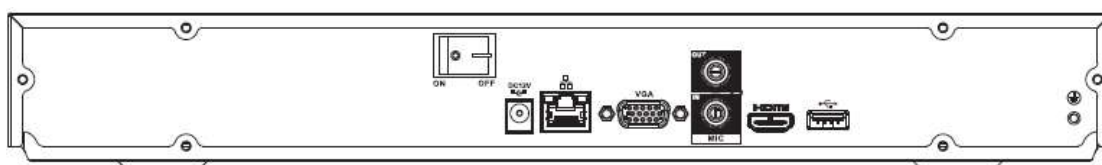

Figure 2-27

The NVR22-P-S2/22-P-4KS2 series rear panel is shown as below. See Figure 2-28.

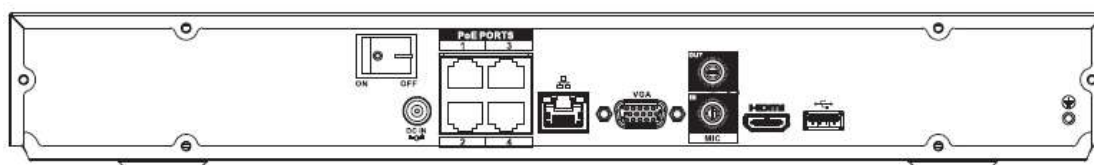

Figure 2-28

The NVR22-8P-S2/22-8P-4KS2 series rear panel is shown as below. See Figure 2-29.

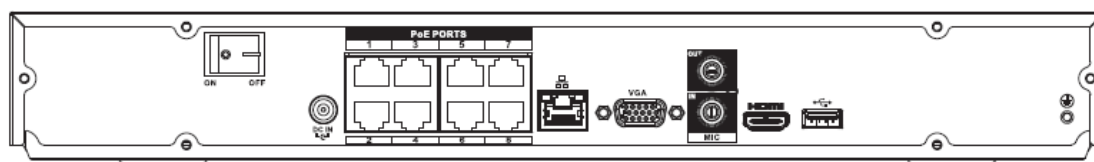





Figure 2-29

Please refer to the following sheet for detailed information.

Port Name	Connection	Function
	Power input port	Power socket. <ul style="list-style-type: none"> For NVR22-S2/22-4KS2, input DC 12V/4A. For NVR22-P-S2/22-P-4KS2, input DC 48V/1.5A. For NVR22-8P-S2/22-8P-4KS2, input DC 53V 120W.
	Network port	10M/100Mbps self-adaptive Ethernet port. Connect to the network cable.
	USB port	USB port. Connect to mouse, USB storage device and etc.
HDMI	High Definition Media Interface	High definition audio and video signal output port. It transmits uncompressed high definition video and multiple-channel data to the HDMI port of the display device. HDMI version is 1.4.
VGA	VGA video output port	VGA video output port. Output analog video signal. It can connect to the monitor to view analog video.
MIC IN	Audio input port	Bidirectional talk input port. It is to receive the analog audio signal output from the devices such as microphone, pickup.
MIC OUT	Audio output port	Audio output port. It is to output the analog audio signal to the devices such as the sound box. <ul style="list-style-type: none"> Bidirectional talk output. Audio output on 1-window video monitor. Audio output on 1-window video playback.
	GND	Ground end
PoE PORTS	PoE port	Built-in switch. Support PoE function. For PoE series product, you can use this port to provide power to the network camera.

2.2.7 NVR42/42N/42-P/42-8P/42-16P Series

The NVR42 series rear panel is shown as below. See Figure 2-30.

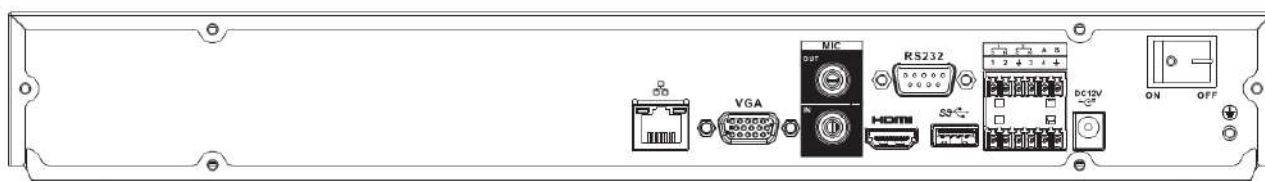

Figure 2-30

The NVR42N series rear panel is shown as below. See Figure 2-31.

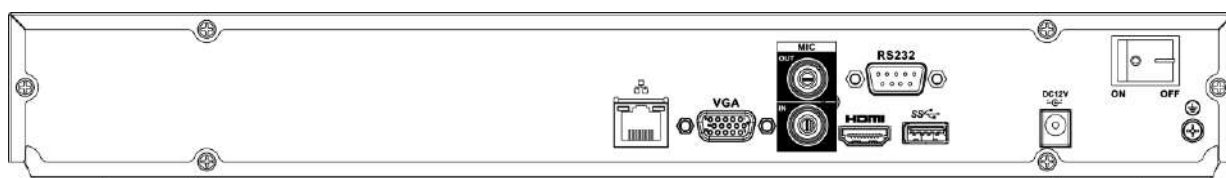





Figure 2-31

The NVR42-P series rear panel is shown as below. See Figure 2-32.

Name		Function
MIC OUT	Audio output port	Audio output port. It is to output the analog audio signal to the devices such as the sound box. <ul style="list-style-type: none"> ● Bidirectional talk output. ● Audio output on 1-window video monitor. ● Audio output on 1-window video playback.
1~4	Alarm input port 1~4	<ul style="list-style-type: none"> ● There are two types; NO (normal open)/NC (normal close). ● When your alarm input device is using external power, please make sure the device and the NVR have the same ground.
	GND	Alarm input ground port.
N1, N2 C1, C2	Alarm output port 1~2	<ul style="list-style-type: none"> ● 2 groups of alarm output ports. (Group 1: port NO1~C1, Group 2: port NO2~C2). Output alarm signal to the alarm device. Please make sure there is power to the external alarm device. ● NO: Normal open alarm output port. ● C: Alarm output public end.
A	RS-485 communication port	RS485_A port. It is the cable A. You can connect to the control devices such as speed dome PTZ.
B		RS485_B. It is the cable B. You can connect to the control devices such as speed dome PTZ.
	Network port	10M/100M/1000Mbps self-adaptive Ethernet port. Connect to the network cable.
	 USB2.0 port	USB2.0 port. Connect to mouse, USB storage device, USB burner and etc.
RS-232	RS-232 debug COM.	It is for general COM debug to configure IP address or transfer transparent COM data.
HDMI	High Definition Media Interface	High definition audio and video signal output port. It transmits uncompressed high definition video and multiple-channel data to the HDMI port of the display device. HDMI version is 1.4.
VGA	VGA video output port	VGA video output port. Output analog video signal. It can connect to the monitor to view analog video.
PoE PORTS	/	Built-in Switch. Support PoE. The 4 PoE series product supports total 48V 50W. The 8 PoE series product supports total 48V 120W. The 16 PoE series product supports total 120W. One PoE port max supports 15W.

2.2.8 NVR52-4KS2/52-8P-4KS2/52-16P-4KS2/5224-24P-4KS2/52-16P-4KS2E Series

The NVR52-4KS2 series rear panel is shown as below. See Figure 2-35.

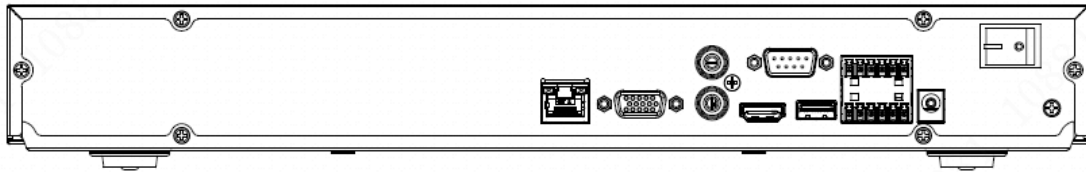

Figure 2-35

The NVR52-8P-4KS2 series rear panel is shown as below. See Figure 2-36.

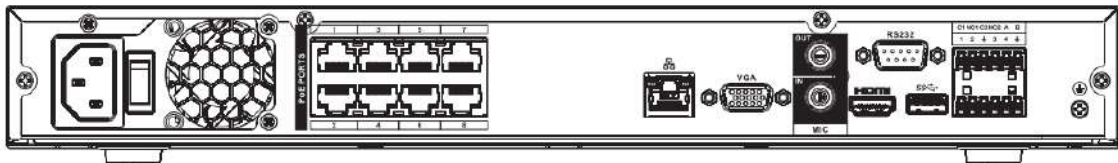

Figure 2-36

The NVR52-16P-4KS2 series rear panel is shown as below. See Figure 2-37.

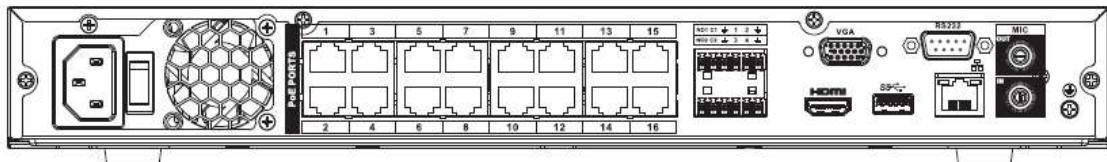

Figure 2-37

The NVR5224-24P-4KS2 series rear panel is shown as below. See Figure 2-38.

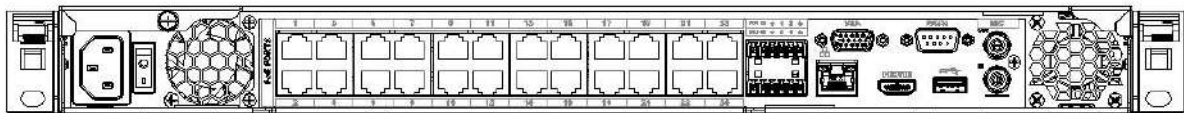

Figure 2-38

The NVR52-16P-4KS2E series rear panel is shown as below. See Figure 2-39.

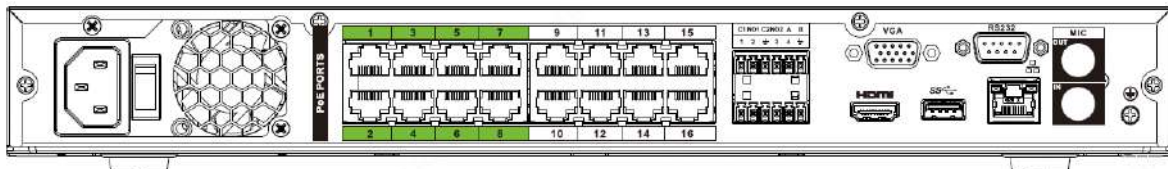





Figure 2-39

Please refer to the following sheet for detailed information.

Icon	Port Name	Function
	Network port	10M/100M/1000Mbps self-adaptive Ethernet port. Connect to the network cable.

Icon	Port Name	Function
HDMI	High Definition Media Interface	High definition audio and video signal output port. It transmits uncompressed high definition video and multiple-channel data to the HDMI port of the display device. HDMI version is 1.4.
	USB3.0 port	USB3.0 port. Connect to mouse, USB storage device, USB burner and etc.
RS-232	RS-232 debug COM.	It is for general COM debug to configure IP address or transfer transparent COM data.
VGA	VGA video output port	VGA video output port. Output analog video signal. It can connect to the monitor to view analog video.
MIC IN	Audio input port	Bidirectional talk input port. It is to receive the analog audio signal output from the devices such as microphone, pickup.
MIC OUT	Audio output port	Audio output port. It is to output the analog audio signal to the devices such as the sound box. <ul style="list-style-type: none"> ● Bidirectional talk output. ● Audio output on 1-window video monitor. ● Audio output on 1-window video playback.
1~8	Alarm input port 1~8	<ul style="list-style-type: none"> ● There are two groups. The first group is from port 1 to port 4; the second group is from port 5 to port 8. They are to receive the signal from the external alarm source. There are two types; NO (normal open)/NC (normal close). ● When your alarm input device is using external power, please make sure the device and the NVR have the same ground.
	GND	Alarm input ground port.
NO1~NO3	Alarm output port 1~3	<ul style="list-style-type: none"> ● 3 groups of alarm output ports. (Group 1:port NO1~C1,Group 2:port NO2~C2,Group 3:port NO3~C3).Output alarm signal to the alarm device. Please make sure there is power to the external alarm device. ● NO: Normal open alarm output port. ● C:Alarm output public end.
C1~C3		
A	RS-485 communication port	RS485_A port. It is the cable A. You can connect to the control devices such as speed dome PTZ.
B		RS485_B.It is the cable B. You can connect to the control devices such as speed dome PTZ.
	Power input port	Input DC 12V/4A.

Icon	Port Name	Function
Power switch	/	Power on/off button.
PoE PORTS	/	<p>Built-in Switch. Support PoE or ePoE function.</p> <ul style="list-style-type: none"> For ePoE series product, port 1 to port 8 are the ePoE ports. ePoE port supports 300 meters@100Mbps, 800 meters@10Mbps. Port 9 to port 16 are general PoE ports. The 8 PoE series product supports total 130W. The 16 PoE series product supports total 130W.

2.2.9 NVR44/44-8P/44-16P Series

The NVR44 series rear panel is shown as below. See Figure 2-40.

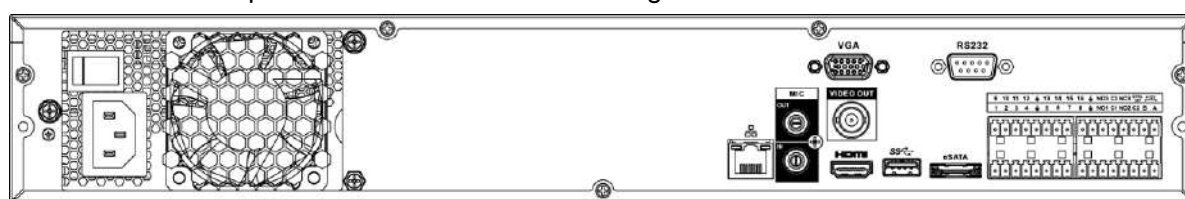

Figure 2-40

The NVR44-8P series rear panel is shown as below. See Figure 2-41.

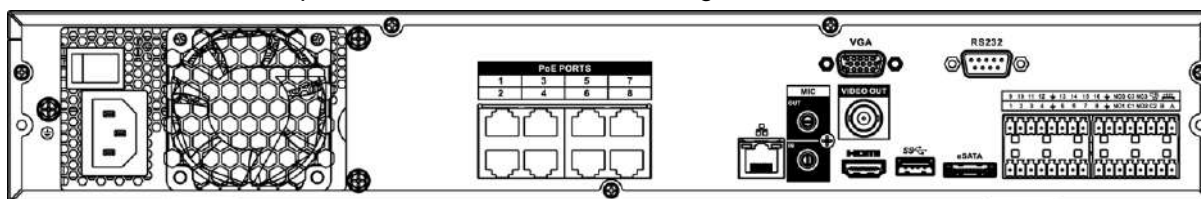

Figure 2-41

The NVR44-16P series rear panel is shown as below. See Figure 4-206.

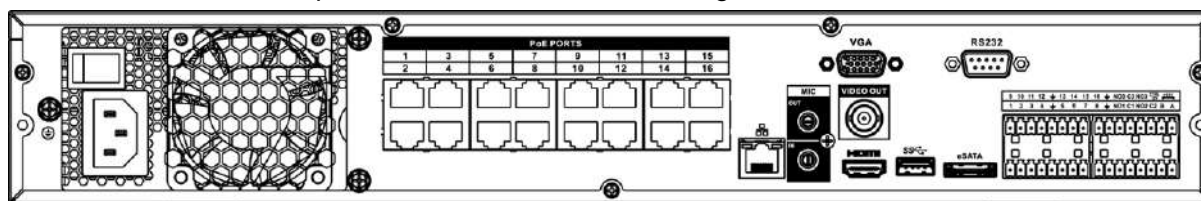





Figure 2-42

Please refer to the following sheet for detailed information.

Name		Function
Power switch	/	Power on-off button
Power input port	/	Input AC 100~240V.

Name		Function
MIC IN	Audio input port	Bidirectional talk input port. It is to receive the analog audio signal output from the devices such as microphone, pickup.
MIC OUT	Audio output port	Audio output port. It is to output the analog audio signal to the devices such as the sound box. <ul style="list-style-type: none"> ● Bidirectional talk output. ● Audio output on 1-window video monitor. ● Audio output on 1-window video playback.
VIEDEO OUT	Video output port	CVBS output
1~16	Alarm input port 1~16	<ul style="list-style-type: none"> ● There are four groups. The first group is from port 1 to port 4, the second group is from port 5 to port 8, the third group is from 9 to 12, and the fourth group is from 13 to 16. They are to receive the signal from the external alarm source. There are two types; NO (normal open)/NC (normal close). ● When your alarm input device is using external power, please make sure the device and the NVR have the same ground.
	Video output port	CVBS output
NO1~NO5 C1~C5 NC5	Alarm output port 1~5	<ul style="list-style-type: none"> ● 5 groups of alarm output ports. (Group 1: port NO1~C1, Group 2: port NO2~C2, Group 3: port NO3~C3, Group 4: port NO4~C4, Group 5: port NO5, C5, NC5). Output alarm signal to the alarm device. Please make sure there is power to the external alarm device. ● NO: Normal open alarm output port. ● C: Alarm output public end. ● NC: Normal close alarm output port.
A	RS-485 communication port	RS485_A port. It is the cable A. You can connect to the control devices such as speed dome PTZ.
B		RS485_B. It is the cable B. You can connect to the control devices such as speed dome PTZ.
CTRL 12V	/	Controller 12V power output. It is to control the on-off alarm relay output. It can be used to control the device alarm output. At the same time, it can also be used as the power input source of some devices such as the alarm detector.
+12V	/	+12V power output port. It can provide the power to some peripheral devices such as the camera or the alarm device. Please note the supplying power shall be below 1A.

Name		Function
	Network port	10M/100M/1000Mbps self-adaptive Ethernet port. Connect to the network cable.
eSATA	eSATA port	External SATA port. It can connect to the device of the SATA port. Please jump the HDD when there is peripheral connected HDD.
	USB2.0 port	USB2.0 port. Connect to mouse, USB storage device, USB burner and etc.
RS-232	RS232 debug COM.	It is for general COM debug to configure IP address or transfer transparent COM data.
HDMI	High Definition Media Interface	High definition audio and video signal output port. It transmits uncompressed high definition video and multiple-channel data to the HDMI port of the display device. HDMI version is 1.3
VGA	VGA video output port	VGA video output port. Output analog video signal. It can connect to the monitor to view analog video.
PoE PORTS	8 PoE ports	Built-in Switch. Support PoE. The 8 PoE ports series products supports total 48V 120W power. One PoE port max supports 15W.
PoE PORTS	16 PoE ports	Built-in Switch. Support PoE. The 16 PoE ports series products supports total 150W power. One PoE port max supports 15W.

2.2.10 NVR54-4KS2/58-4KS2/54-16P-4KS2/58-16P-4KS2/5424-24P-4KS2/5816P-4KS2E Series

The NVR54-4KS2/NVR58-4KS2 series rear panel is shown as below. See Figure 2-43.

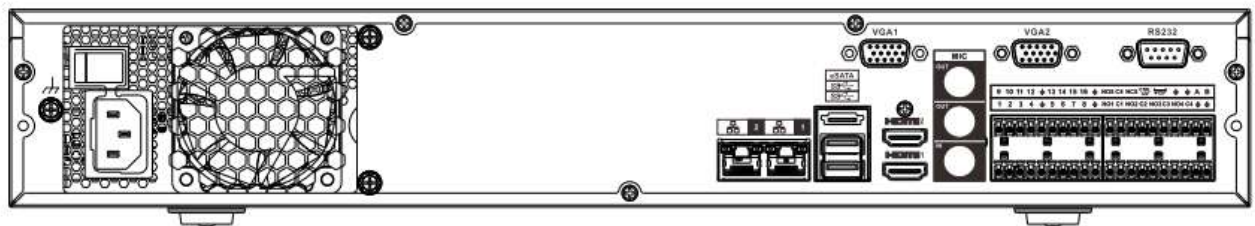

Figure 2-43

The NVR54-16P-4KS2/NVR58-16P-4KS2 series rear panel is shown as below. See Figure 2-44.

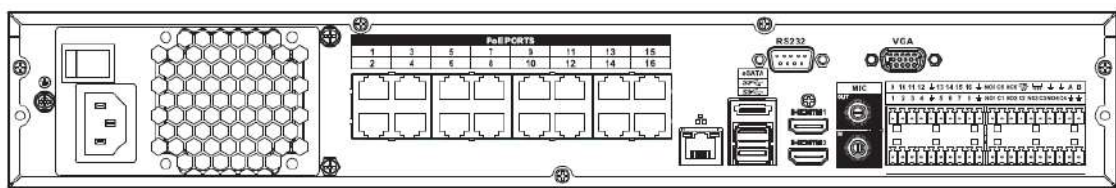

Figure 2-44

The NVR5424-24P-4KS2 series rear panel is shown as below. See Figure 2-45.

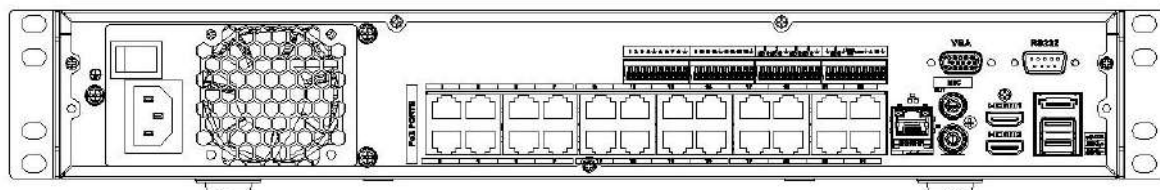

Figure 2-45

The NVR54-16P-4KS2E series rear panel is shown as below. See Figure 2-46.

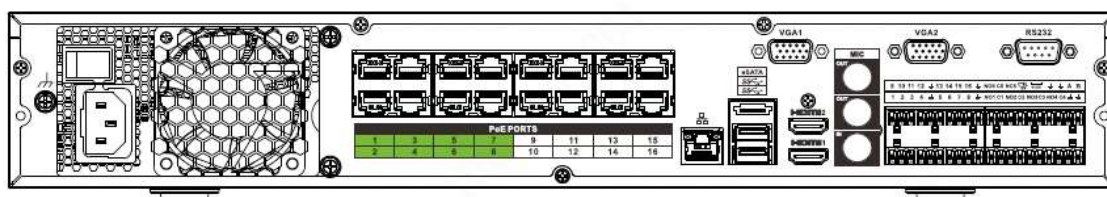

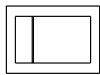



Figure 2-46

The NVR58-16P-4KS2E series rear panel is shown as below. See Figure 2-47.



Figure 2-47

Please refer to the following sheet for detailed information.

Name		Function
	Power switch	Power on-off button
	Power input port	Input AC 100~240V.
	Network port	10M/100M/1000Mbps self-adaptive Ethernet port. Connect to the network cable.
eSATA	eSATA port	External SATA port. It can connect to the device of the SATA port. Please jump the HDD when there is peripheral connected HDD.
	USB3.0 port	USB3.0 port. Connect to mouse, USB storage device, USB burner and etc.

Name		Function
HDMI	High Definition Media Interface	High definition audio and video signal output port. It transmits uncompressed high definition video and multiple-channel data to the HDMI port of the display device. HDMI version is 1.4b.
MIC IN	Audio input port	Bidirectional talk input port. It is to receive the analog audio signal output from the devices such as microphone, pickup.
MIC OUT	Audio output port	Audio output port. It is to output the analog audio signal to the devices such as the sound box. <ul style="list-style-type: none"> ● Bidirectional talk output. ● Audio output on 1-window video monitor. ● Audio output on 1-window video playback.
1~16	Alarm input port 1~16	<ul style="list-style-type: none"> ● There are four groups. The first group is from port 1 to port 4, the second group is from port 5 to port 8, the third group is from 9 to 12, and the fourth group is from 13 to 16. They are to receive the signal from the external alarm source. There are two types; NO (normal open)/NC (normal close). ● When your alarm input device is using external power, please make sure the device and the NVR have the same ground.
	Ground	Alarm input ground end.
NO1~NO5 C1~C5 NC5	Alarm output port 1~5	<ul style="list-style-type: none"> ● 5 groups of alarm output ports. (Group 1:port NO1~C1,Group 2:port NO2~C2,Group 3:port NO3~C3, Group 4:port NO4~C4, Group 5: port NO5, C5, NC5).Output alarm signal to the alarm device. Please make sure there is power to the external alarm device. ● NO: Normal open alarm output port. ● C: Alarm output public end. ● NC: Normal close alarm output port.
A	RS-485 communication port	RS485_A port. It is the cable A. You can connect to the control devices such as speed dome PTZ.
B		RS485_B.It is the cable B. You can connect to the control devices such as speed dome PTZ.
CTRL 12V	/	Controller 12V power output. It is to control the on-off alarm relay output. It can be used to control the device alarm output. At the same time, it can also be used as the power input source of some devices such as the alarm detector.

Name		Function
+12V	/	+12V power output port. It can provide the power to some peripheral devices such as the camera or the alarm device. Please note the supplying power shall be below 1A.
RS-232	RS232 debug COM.	It is for general COM debug to configure IP address or transfer transparent COM data.
VGA	VGA video output port	VGA video output port. Output analog video signal. It can connect to the monitor to view analog video.
PoE PORTS	/	<p>Built-in Switch. Support PoE or ePoE function.</p> <ul style="list-style-type: none"> For ePoE series product, port 1 to port 8 are the ePoE ports. ePoE port supports 300 meters@100Mbps, 800 meters@10Mbps. Port 9 to port 16 are general PoE ports. The 16 PoE series product supports total 150W.

2.2.11 NVR48/48-16P Series

The NVR48 series rear panel is shown as below. See Figure 2-48.

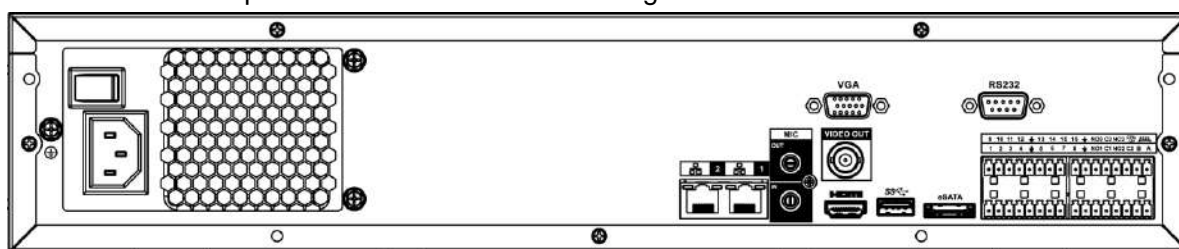

Figure 2-48

The NVR48-16P series rear panel is shown as below. See Figure 2-49.

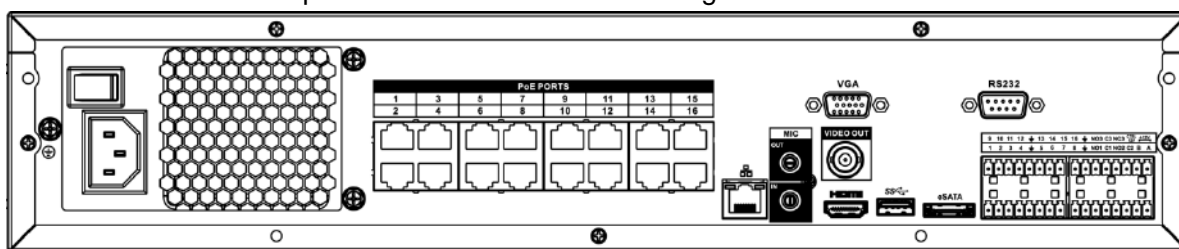





Figure 2-49

Please refer to the following sheet for detailed information.

Name		Function
Power switch	/	Power on-off button
Power input port	/	Input AC 100~240V.
MIC IN	Audio input port	Bidirectional talk input port. It is to receive the analog audio signal output from the devices such as microphone, pickup.

Name		Function
MIC OUT	Audio output port	Audio output port. It is to output the analog audio signal to the devices such as the sound box. <ul style="list-style-type: none"> ● Bidirectional talk output. ● Audio output on 1-window video monitor. ● Audio output on 1-window video playback.
VIDEO OUT	Video output port	CVBS output.
1~16	Alarm input port 1~16	<ul style="list-style-type: none"> ● There are four groups. The first group is from port 1 to port 4, the second group is from port 5 to port 8, the third group is from 9 to 12, and the fourth group is from 13 to 16. They are to receive the signal from the external alarm source. There are two types; NO (normal open)/NC (normal close). ● When your alarm input device is using external power, please make sure the device and the NVR have the same ground.
	GND	Alarm input ground port.
NO1~NO5 C1~C5 NC5	Alarm output port 1~5	<ul style="list-style-type: none"> ● 5 groups of alarm output ports. (Group 1: port NO1~C1, Group 2: port NO2~C2, Group 3: port NO3~C3, Group 4: port NO4~C4, Group 5: port NO5, C5, NC5). Output alarm signal to the alarm device. Please make sure there is power to the external alarm device. ● NO: Normal open alarm output port. ● C: Alarm output public end. ● NC: Normal close alarm output port.
A	RS-485 communication port	RS485_A port. It is the cable A. You can connect to the control devices such as speed dome PTZ.
B		RS485_B. It is the cable B. You can connect to the control devices such as speed dome PTZ.
CTRL 12V	/	Controller 12V power output. It is to control the on-off alarm relay output. It can be used to control the device alarm output. At the same time, it can also be used as the power input source of some devices such as the alarm detector.
+12V	/	+12V power output port. It can provide the power to some peripheral devices such as the camera or the alarm device. Please note the supplying power shall be below 1A.
	Network port	One 10M/100M/1000Mbps self-adaptive Ethernet port. Connect to the network cable.
eSATA	eSATA port	External SATA port. It can connect to the device of the SATA port. Please jump the HDD when there is peripheral connected HDD.

Name		Function
	USB2.0 port	USB2.0 port. Connect to mouse, USB storage device, USB burner and etc.
RS-232	RS-232 debug COM.	It is for general COM debug to configure IP address or transfer transparent COM data.
HDMI	High Definition Media Interface	High definition audio and video signal output port. It transmits uncompressed high definition video and multiple-channel data to the HDMI port of the display device. HDMI version is 1.3.
VGA	VGA video output port	VGA video output port. Output analog video signal. It can connect to the monitor to view analog video.
PoE PORTS	16 PoE ports	Built-in Switch. Support PoE. The 16 PoE ports series products supports total 150W power. One PoE port max supports 15W.

2.2.12 NVR42V-8P Series

The interface is shown as in Figure 2-50.

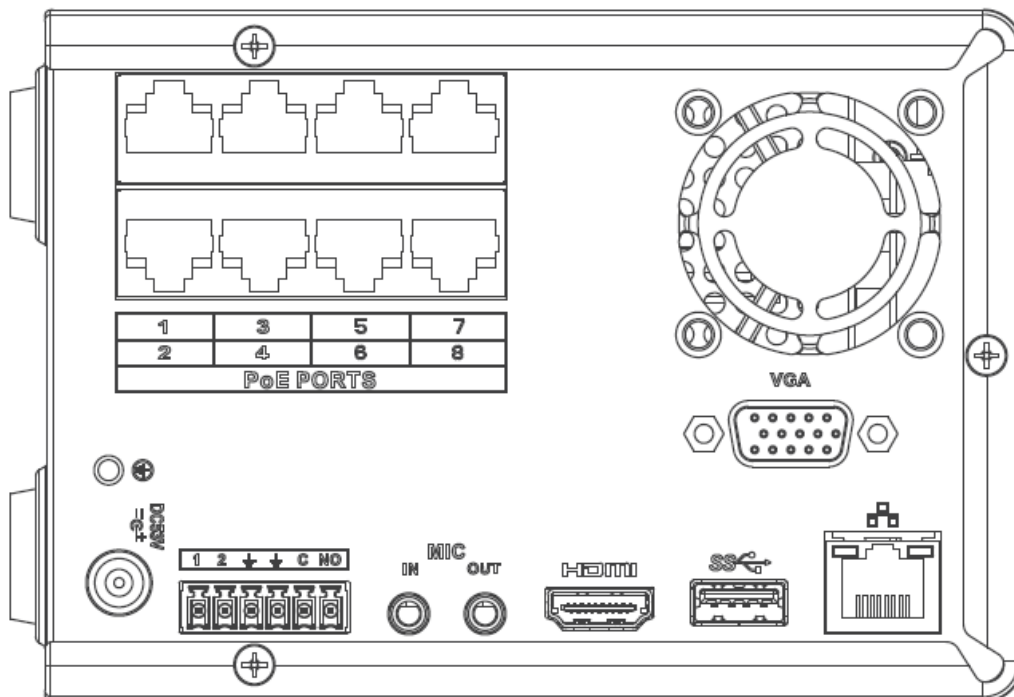





Figure 2-50

Please refer to the following sheet for detailed information.

Name		Function
Power switch	/	Power on/off button.
	Power input port	Input DC 53V--2.3A

Name		Function
MIC IN	Audio input port	Bidirectional talk input port. It is to receive the analog audio signal output from the devices such as microphone, pickup.
MIC OUT	Audio output port	Audio output port. It is to output the analog audio signal to the devices such as the sound box. <ul style="list-style-type: none"> ● Bidirectional talk output. ● Audio output on 1-window video monitor. ● Audio output on 1-window video playback.
1~2	Alarm input port 1~2	<ul style="list-style-type: none"> ● When your alarm input device is using external power, please make sure the device and the NVR have the same ground.
	GND	Alarm input ground port.
C	Alarm output public port	Alarm output public end.
NO	Normal open	Normal open alarm output port.
	Network port	10M/100M/1000Mbps self-adaptive Ethernet port. Connect to the network cable.
	USB3.0 port	USB3.0 port. Connect to mouse, USB storage device, USB burner and etc.
HDMI	High Definition Media Interface	High definition audio and video signal output port. It transmits uncompressed high definition video and multiple-channel data to the HDMI port of the display device. HDMI version is 1.4.
VGA	VGA video output port	VGA video output port. Output analog video signal. It can connect to the monitor to view analog video.
PoE PORT	/	Bult-in Switch. Support PoE. The 8 PoE series product supports total 48V 120W. One PoE port max supports 15W.

2.2.13 NVR41-4KS2/41-P-4KS2/41-8P-4KS2

The NVR41-4KS2 series rear panel is shown as below. See Figure 2-51.

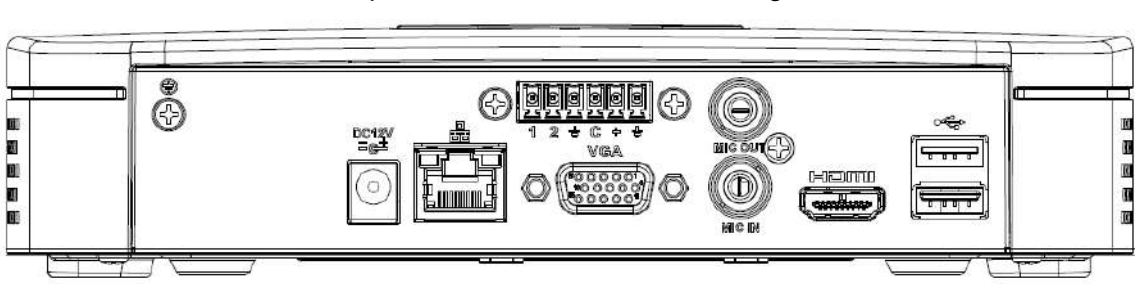

Figure 2-51

The NVR41-P-4KS2 series rear panel is shown as below. See Figure 2-52.

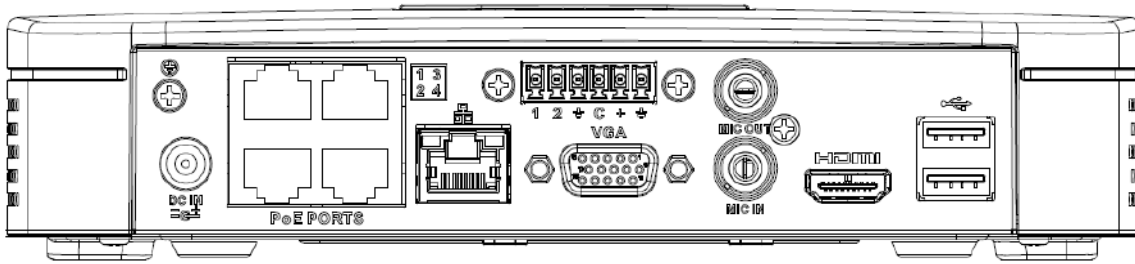

Figure 2-52

The NVR41-8P-4KS2 series rear panel is shown as below. See Figure 2-53.

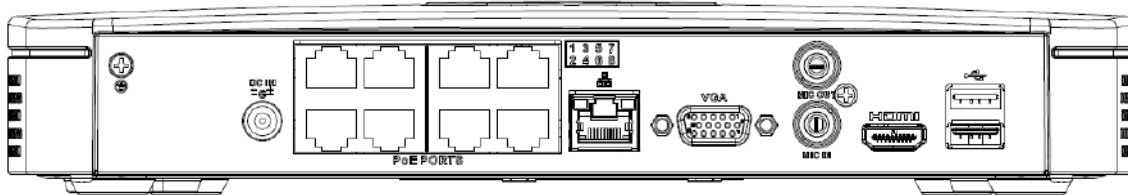



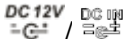

Figure 2-53

Please refer to the following sheet for detailed information.

Port Name	Connection	Function
	USB port	USB port. Connect to mouse, USB storage device, USB burner and etc.
	Network port	10M/100Mbps self-adaptive Ethernet port. Connect to the network cable.
HDMI	High Definition Media Interface	High definition audio and video signal output port. It transmits uncompressed high definition video and multiple-channel data to the HDMI port of the display device. HDMI version is 1.4.
VGA	VGA video output port	VGA video output port. Output analog video signal. It can connect to the monitor to view analog video.
	GND	Ground end
	Power input port	Power socket. For NVR41-4KS2: DC 12V/2A power. For NVR41-P-4KS2: DC 48V/72W power. For NVR41-8P-4KS2: DC 48V/96W power.
MIC IN	Audio input port	Bidirectional talk input port. It is to receive the analog audio signal output from the devices such as microphone, pickup.
MIC OUT	Audio output port	Audio output port. It is to output the analog audio signal to the devices such as the sound box. <ul style="list-style-type: none"> ● Bidirectional talk output. ● Audio output on 1-window video monitor. ● Audio output on 1-window video playback.

Port Name	Connection	Function
PoE PORT	PoE port	Built-in switch. Support PoE function. For PoE series product, you can use this port to provide power to the network camera.

2.2.14 NVR41HS-4KS2/41HS-P-4KS2/41HS-8P-4KS2

The NVR41HS-4KS2 series rear panel is shown as below. See Figure 2-54.

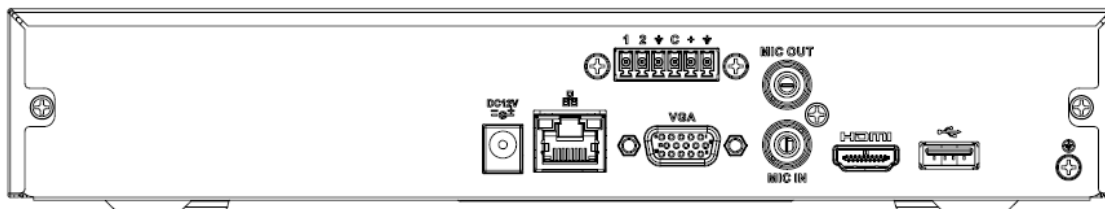

Figure 2-54

The NVR41HS-P-4KS2 series rear panel is shown as below. See Figure 2-55.

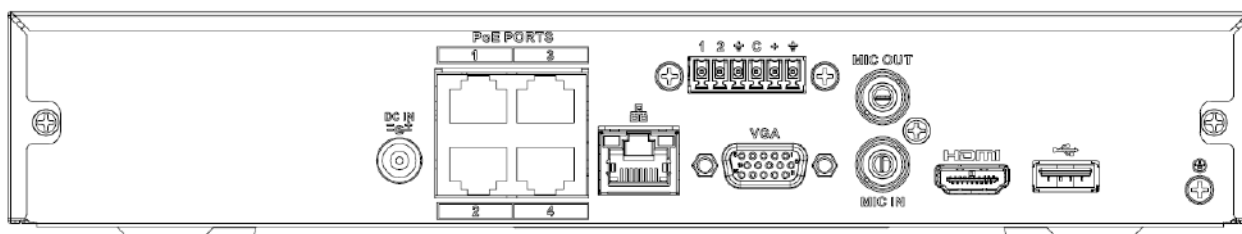

Figure 2-55

The NVR41HS-8P-4KS2 series rear panel is shown as below. See Figure 2-56

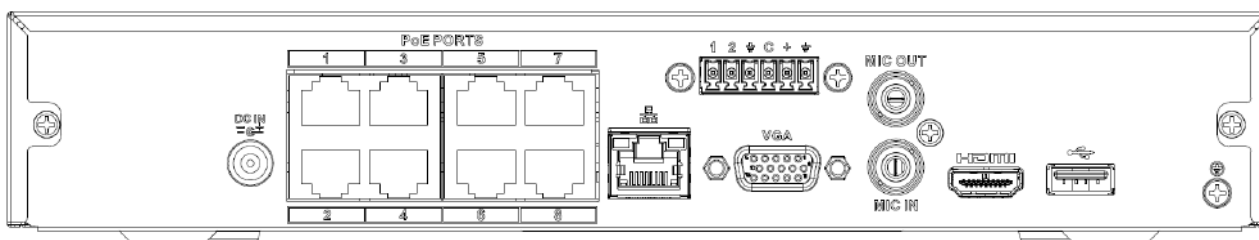

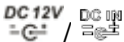





Figure 2-56

Please refer to the following sheet for detailed information.

Port Name	Connection	Function
	USB port	USB port. Connect to mouse, USB storage device, USB burner and etc.
	Power input port	Power socket. For NVR41HS-4KS2: DC 12V/2A power. For NVR41HS-P-4KS2: DC 48V/72W power. For NVR41HS-8P-4KS2: DC 48V/96W power.

Port Name	Connection	Function
	Network port	10M/100Mbps self-adaptive Ethernet port. Connect to the network cable.
	USB port	USB port. Connect to mouse, USB storage device and etc.
HDMI	High Definition Media Interface	High definition audio and video signal output port. It transmits uncompressed high definition video and multiple-channel data to the HDMI port of the display device. HDMI version is 1.4.
VGA	VGA video output port	VGA video output port. Output analog video signal. It can connect to the monitor to view analog video.
MIC IN	Audio input port	Bidirectional talk input port. It is to receive the analog audio signal output from the devices such as microphone, pickup.
MIC OUT	Audio output port	Audio output port. It is to output the analog audio signal to the devices such as the sound box. <ul style="list-style-type: none"> ● Bidirectional talk output. ● Audio output on 1-window video monitor. ● Audio output on 1-window video playback.
	GND	Ground end
PoE PORTS	PoE port	Built-in switch. Support PoE function. For PoE series product, you can use this port to provide power to the network camera.

2.2.15 NVR42-4KS2/42-P-4KS2/42-8P-4KS2/42-16P-4KS2

The NVR42-4KS2 series rear panel is shown as below. See Figure 2-57.

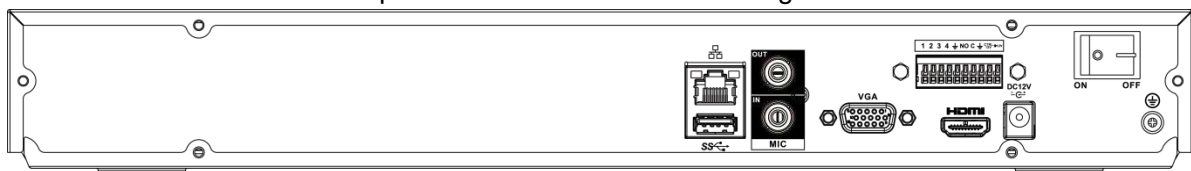

Figure 2-57

The NVR42-P-4KS2 series rear panel is shown as below. See Figure 2-58.

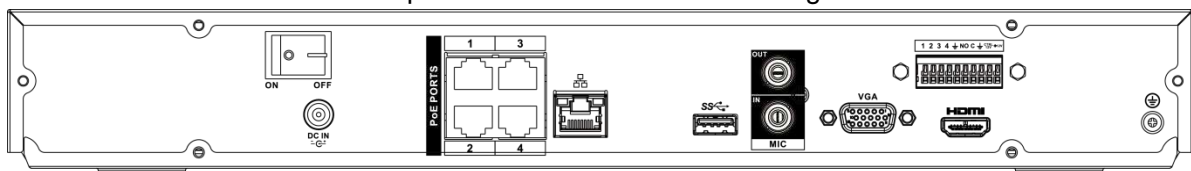

Figure 2-58

The NVR42-8P-4KS2 series rear panel is shown as below. See Figure 2-59.

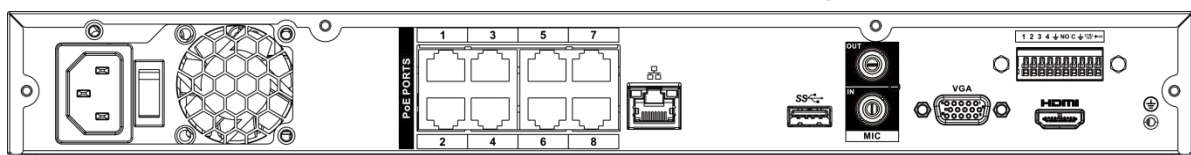

Figure 2-59

The NVR42-16P-4KS2 series rear panel is shown as below. See Figure 2-60.

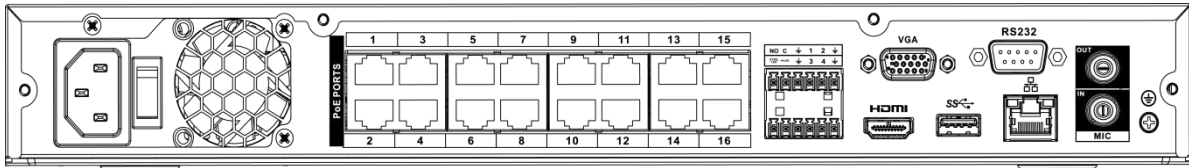
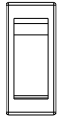









Figure 2-60

Please refer to the following sheet for detailed information.

Name		Function
	Power switch	Power on/off button.
		
	Power input port	Input DC 12V/4A. For NVR42-4KS2 series product only.
		Switch power port. Input DC 48/96W For NVR42-P-4KS2 series product only.
		Input AC90V~264V-12V5A/52V2.5A-190W. For NVR42-8P-4KS2/NVR42-16P-4KS2 series product only.
MIC IN	Audio input port	Bidirectional talk input port. It is to receive the analog audio signal output from the devices such as microphone, pickup.
MIC OUT	Audio output port	Audio output port. It is to output the analog audio signal to the devices such as the sound box. <ul style="list-style-type: none"> ● Bidirectional talk output. ● Audio output on 1-window video monitor. ● Audio output on 1-window video playback.
1~4	Alarm input port 1~4	<ul style="list-style-type: none"> ● There are two types; NO (normal open)/NC (normal close). ● When your alarm input device is using external power, please make sure the device and the NVR have the same ground.
	GND	Alarm input ground port.
N1, N2	Alarm output port 1~2	<ul style="list-style-type: none"> ● 2 groups of alarm output ports. (Group 1:port NO1~C1,Group 2:port NO2~C2).Output alarm signal to the alarm device. Please make sure there is power to the external alarm device. ● NO: Normal open alarm output port. ● C:Alarm output public end.
C1, C2		

Name		Function
Power switch	/	Power on-off button
Power input port	/	AC90V~264V-12V12.5A/-53V2.83A
MIC IN	Audio input port	Bidirectional talk input port. It is to receive the analog audio signal output from the devices such as microphone, pickup.
MIC OUT	Audio output port	Audio output port. It is to output the analog audio signal to the devices such as the sound box. <ul style="list-style-type: none"> ● Bidirectional talk output. ● Audio output on 1-window video monitor. ● Audio output on 1-window video playback.
VIEDEO OUT	Video output port	CVBS output
1~16	Alarm input port 1~16	<ul style="list-style-type: none"> ● There are four groups. The first group is from port 1 to port 4, the second group is from port 5 to port 8, the third group is from 9 to 12, and the fourth group is from 13 to 16. They are to receive the signal from the external alarm source. There are two types; NO (normal open)/NC (normal close). ● When your alarm input device is using external power, please make sure the device and the NVR have the same ground.
	Video output port	CVBS output
NO1~NO5 C1~C5 NC5	Alarm output port 1~5	<ul style="list-style-type: none"> ● 5 groups of alarm output ports. (Group 1:port NO1~C1,Group 2:port NO2~C2,Group 3:port NO3~C3, Group 4:port NO4~C4, Group 5: port NO5, C5, NC5).Output alarm signal to the alarm device. Please make sure there is power to the external alarm device. ● NO: Normal open alarm output port. ● C: Alarm output public end. ● NC: Normal close alarm output port.
A	RS-485 communication port	RS485_A port. It is the cable A. You can connect to the control devices such as speed dome PTZ.
B		RS485_B.It is the cable B. You can connect to the control devices such as speed dome PTZ.
CTRL 12V	/	Controller 12V power output. It is to control the on-off alarm relay output. It can be used to control the device alarm output. At the same time, it can also be used as the power input source of some devices such as the alarm detector.

Name		Function
+12V	/	+12V power output port. It can provide the power to some peripheral devices such as the camera or the alarm device. Please note the supplying power shall be below 1A.
	Network port	10M/100M/1000Mbps self-adaptive Ethernet port. Connect to the network cable.
eSATA	eSATA port	External SATA port. It can connect to the device of the SATA port. Please jump the HDD when there is peripheral connected HDD.
	USB2.0 port	USB2.0 port. Connect to mouse, USB storage device, USB burner and etc.
RS-232	RS232 debug COM.	It is for general COM debug to configure IP address or transfer transparent COM data.
HDMI	High Definition Media Interface	High definition audio and video signal output port. It transmits uncompressed high definition video and multiple-channel data to the HDMI port of the display device. HDMI version is 1.3
VGA	VGA video output port	VGA video output port. Output analog video signal. It can connect to the monitor to view analog video.
PoE PORTS	PoE port	Built-in Switch. Support PoE. For PoE series product, you can use this port to provide power to the network camera.

2.2.17 NVR48-4KS2/48-16P-4KS2 Series

The NVR48-4KS2 series rear panel is shown as below. See Figure 2-63.

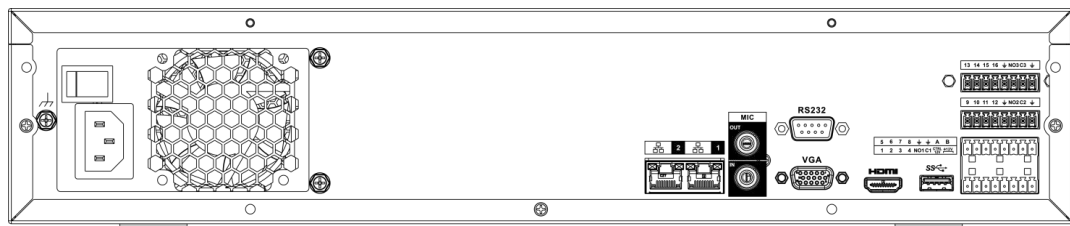

Figure 2-63

The NVR48-16P-4KS2 series rear panel is shown as below. See Figure 2-64.

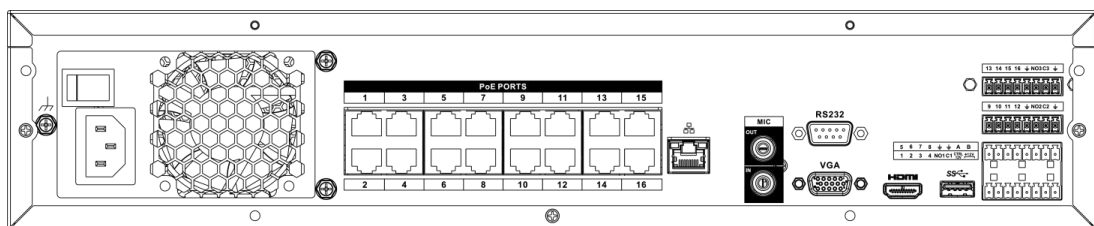





Figure 2-64

Please refer to the following sheet for detailed information.

Name		Function
Power switch	/	Power on-off button
Power input port	/	AC90V~264V-12V12.5A/-53V2.83A
MIC IN	Audio input port	Bidirectional talk input port. It is to receive the analog audio signal output from the devices such as microphone, pickup.
MIC OUT	Audio output port	Audio output port. It is to output the analog audio signal to the devices such as the sound box. <ul style="list-style-type: none"> ● Bidirectional talk output. ● Audio output on 1-window video monitor. ● Audio output on 1-window video playback.
VIDEO OUT	Video output port	CVBS output.
1~16	Alarm input port 1~16	<ul style="list-style-type: none"> ● There are four groups. The first group is from port 1 to port 4, the second group is from port 5 to port 8, the third group is from 9 to 12, and the fourth group is from 13 to 16. They are to receive the signal from the external alarm source. There are two types; NO (normal open)/NC (normal close). ● When your alarm input device is using external power, please make sure the device and the NVR have the same ground.
	GND	Alarm input ground port.
NO1~NO5 C1~C5 NC5	Alarm output port 1~5	<ul style="list-style-type: none"> ● 5 groups of alarm output ports. (Group 1:port NO1~C1,Group 2:port NO2~C2,Group 3:port NO3~C3, Group 4:port NO4~C4, Group 5: port NO5, C5, NC5).Output alarm signal to the alarm device. Please make sure there is power to the external alarm device. ● NO: Normal open alarm output port. ● C: Alarm output public end. ● NC: Normal close alarm output port.
A	RS-485 communication port	RS485_A port. It is the cable A. You can connect to the control devices such as speed dome PTZ.
B		RS485_B.It is the cable B. You can connect to the control devices such as speed dome PTZ.
CTRL 12V	/	Controller 12V power output. It is to control the on-off alarm relay output. It can be used to control the device alarm output. At the same time, it can also be used as the power input source of some devices such as the alarm detector.

Name		Function
+12V	/	+12V power output port. It can provide the power to some peripheral devices such as the camera or the alarm device. Please note the supplying power shall be below 1A.
	Network port	One 10M/100M/1000Mbps self-adaptive Ethernet port. Connect to the network cable.
eSATA	eSATA port	External SATA port. It can connect to the device of the SATA port. Please jump the HDD when there is peripheral connected HDD.
	USB port	USB port. Connect to mouse, USB storage device, USB burner and etc.
RS-232	RS-232 debug COM.	It is for general COM debug to configure IP address or transfer transparent COM data.
HDMI	High Definition Media Interface	High definition audio and video signal output port. It transmits uncompressed high definition video and multiple-channel data to the HDMI port of the display device. HDMI version is 1.4.
VGA	VGA video output port	VGA video output port. Output analog video signal. It can connect to the monitor to view analog video.
PoE PORTS	PoE port	Built-in Switch. Support PoE. For PoE series product, you can use this port to provide power to the network camera.

2.3 Alarm Connection

2.3.1 Alarm Port

The alarm port is shown as below. See Figure 2-65. The following figure for reference only.

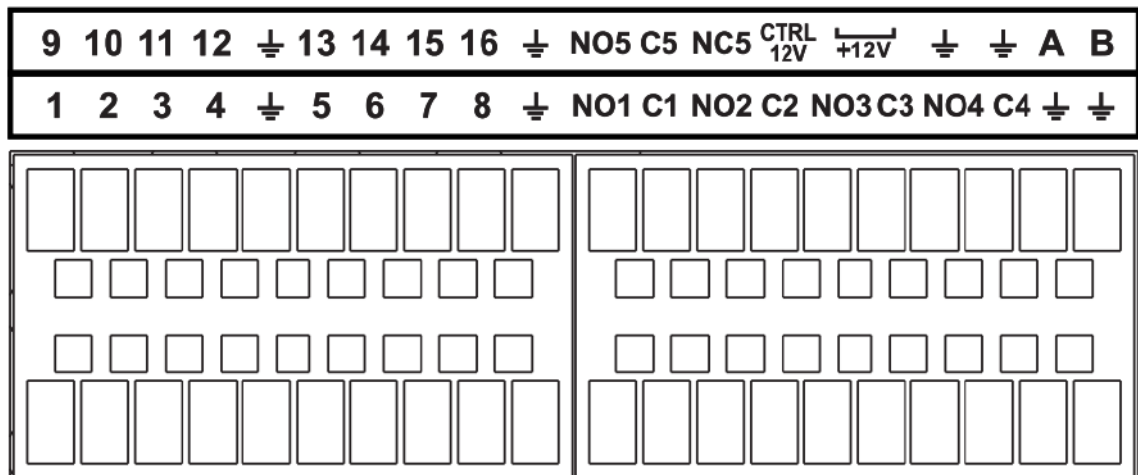



Figure 2-65

Icon	Function
------	----------

1~16	ALARM1~ALARM16. The alarm becomes activated in the low level.
NO1 C1, NO2 C2, NO3 C3, NO4 C4	Four NO activation output groups. (On-off button).
NO5 C5 NC5	One NO/NC activation output group. (On-off button).
CTRL 12V	Control power output. Disable power output when alarm is canceled. Current is 500mA.
+12V	Rated current output. Current is 500mA.
	GND
A/B	485 communication port. They are used to control devices such as PTZ. Please parallel connect 120TΩ between A/B cables if there are too many PTZ decoders.

Note

- Different models support different alarm input ports. Please refer to the specifications sheet for detailed information.
- Slight difference may be found on the alarm port layout.

2.3.2 Alarm input port

Connect the positive end (+) of the alarm input device to the alarm input port (ALARM IN 1~16) of the NVR. Connect the negative end (-) of the alarm input device to the ground end () of the NVR.

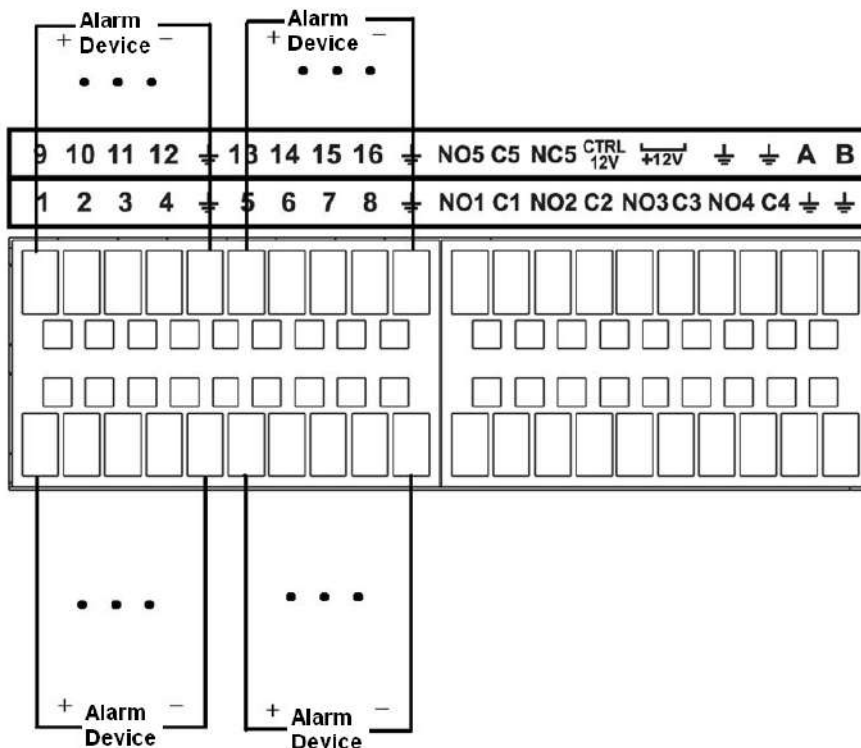

Figure 2-66

Note

- There are two alarm input types: NO/NC.
- When connect the ground port of the alarm device to the NVR, you can use any of the GND ports



- Connect the NC port of the alarm device to the alarm input port (ALARM) of the NVR.
- When there is peripheral power supplying for the alarm device, please make sure it is earthed with the NVR.

2.3.3 Alarm input and output port

- There is peripheral power supplying for the external alarm device.
- In case overload may result in NVR damage, please refer to the following relay specifications for detailed information.
- A/B cable of the RS485 is for the A/B cable connection of the speed PTZ.

2.3.4 Alarm relay specifications

Model:	JRC-27F	
Material of the touch	Silver	
Rating (Resistance Load)	Rated switch capacity	30VDC 2A, 125VAC 1A
	Maximum switch power	125VA 160W
	Maximum switch voltage	250VAC, 220VDC
	Maximum switch current	1A
Insulation	Between touches with same polarity	1000VAC 1minute
	Between touches with different polarity	1000VAC 1minute
	Between touch and winding	1000VAC 1minute
Surge voltage	Between touches with same polarity	1500V (10×160us)
Length of open time	3ms max	
Length of close time	3ms max	
Longevity	Mechanical	50×10 ⁶ MIN (3Hz)
	Electrical	200×10 ³ MIN (0.5Hz)
Temperature	-40℃ ~+70℃	

2.4 Bidirectional talk

2.4.1 Device-end to PC-end

Device Connection

Please connect the speaker or the pickup to the first audio input port in the device rear panel. Then connect the earphone or the sound box to the audio output port in the PC.

Login the Web and then enable the corresponding channel real-time monitor.

Please refer to the following interface to enable bidirectional talk. See Figure 2-67.

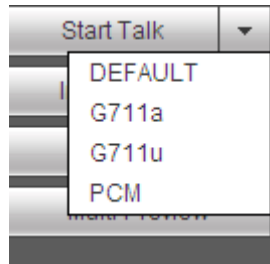

Figure 2-67

Listening Operation

At the device end, speak via the speaker or the pickup, and then you can get the audio from the earphone or sound box at the pc-end. See Figure 2-68.

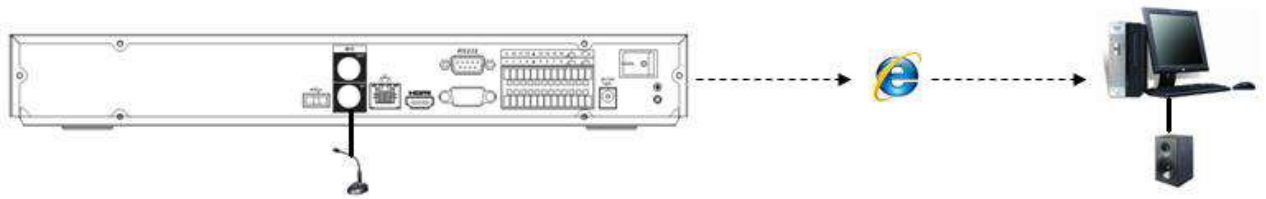

Figure 2-68

2.4.2 PC-end to the device-end

Device Connection

Connect the speaker or the pickup to the audio output port in the PC and then connect the earphone or the sound box to the first audio input port in the device rear panel.

Login the Web and then enable the corresponding channel real-time monitor.

Please refer to the above interface (Figure 2-67) to enable bidirectional talk.

Listening Operation

At the PC-end, speak via the speaker or the pickup, and then you can get the audio from the earphone or sound box at the device-end. See Figure 2-69.

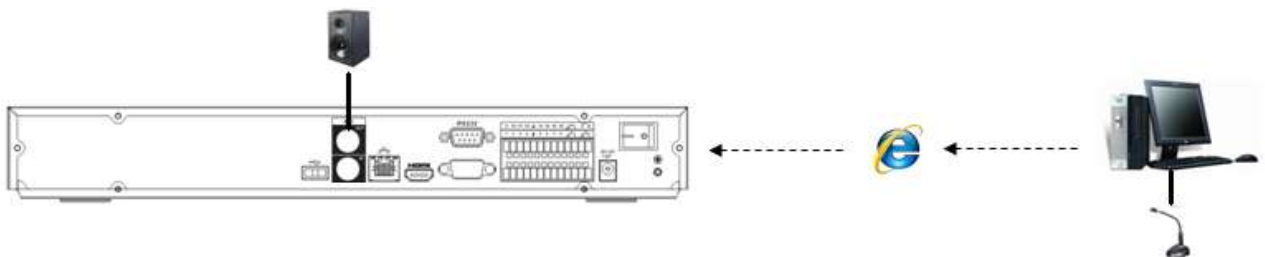
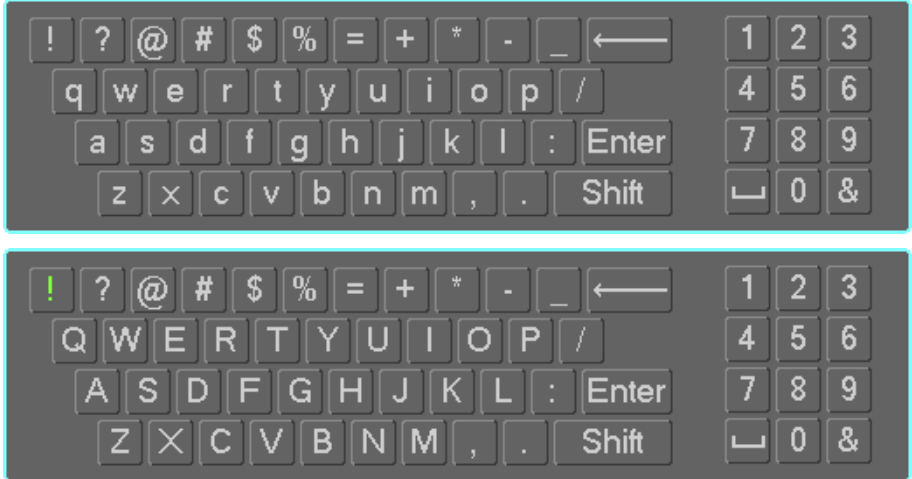

Figure 2-69

2.5 Mouse Operation

Please refer to the following sheet for mouse operation instruction.

Left mouse	click	When you have selected one menu item, left click mouse to view menu content.
		Modify checkbox or motion detection status.
		Click combo box to pop up dropdown list

	<p>In input box, you can select input methods. Left click the corresponding button on the panel you can input numeral/English character (small/capitalized). Here ← stands for backspace button. _ stands for space button.</p> <p>In English input mode: _stands for input a backspace icon and ← stands for deleting the previous character.</p>  <p>In numeral input mode: _ stands for clear and ← stands for deleting the previous numeral.</p>
Double left click mouse	<p>Implement special control operation such as double click one item in the file list to playback the video.</p> <p>In multiple-window mode, double left click one channel to view in full-window. Double left click current video again to go back to previous multiple-window mode.</p>
Right click mouse	<p>In real-time monitor mode, pops up shortcut menu.</p> <p>Exit current menu without saving the modification.</p>
Press middle button	<p>In numeral input box: Increase or decrease numeral value.</p> <p>Switch the items in the check box.</p> <p>Page up or page down</p>
Move mouse	Select current control or move control
Drag mouse	<p>Select motion detection zone</p> <p>Select privacy mask zone.</p>

2.6 Remote Control

The remote control interface is shown as in Figure 2-70.

Please note remote control is not our standard accessory and it is not included in the accessory bag.

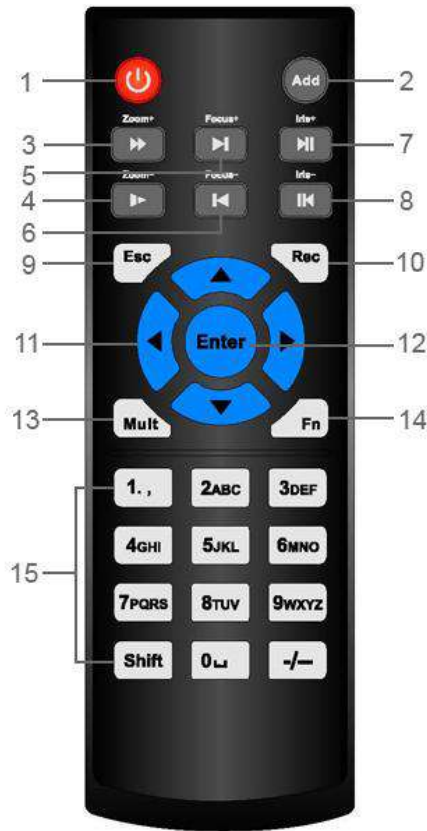

Figure 2-70

Serial Number	Name	Function
1	Power button	Click it to boot up or shut down the device.
2	Address	Click it to input device number, so that you can control it.
3	Forward	Various forward speeds and normal speed playback.
4	Slow play	Multiple slow play speeds or normal playback.
5	Next record	In playback mode, playback the next video.
6	Previous record	In playback mode, playback the previous video.
7	Play/Pause	In pause mode, click this button to realize normal playback.
		In normal playback click this button to pause playback.
		In real-time monitor mode, click this button to enter video search menu.
8	Reverse/pause	Reverse playback pause mode, click this button to realize normal playback.

		In reverse playback click this button to pause playback.
9	Esc.	Go back to previous menu or cancel current operation (close upper interface or control)
10	Record	Start or stop record manually In record interface, working with the direction buttons to select the record channel. Click this button for at least 1.5 seconds, system can go to the Manual Record interface.
11	Direction keys	Switch current activated control, go to left or right. In playback mode, it is to control the playback process bar. Aux function(such as switch the PTZ menu)
12	Enter /menu key	go to default button go to the menu
13	Multiple-window switch	Switch between multiple-window and one-window.
14	Fn	In 1-ch monitor mode: pop up assistant function:PTZ control and Video color.
		Switch the PTZ control menu in PTZ control interface.
		In motion detection interface, working with direction keys to complete setup.
		In text mode, click it to delete character.
15	0-9 number key	Input password, channel or switch channel.
		Shift is the button to switch the input method.

3 Device Installation

Note: All the installation and operations here should conform to your local electric safety rules.

3.1 Device Installation Diagrams

Please refer to the following diagrams to install the NVR.

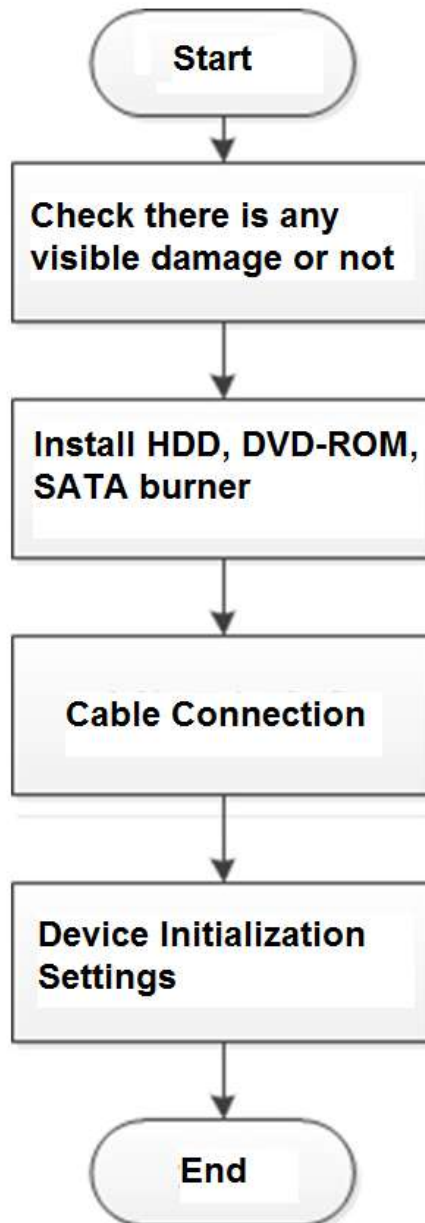

3.2 Check Unpacked NVR

When you receive the NVR from the forwarding agent, please check whether there is any visible damage. The protective materials used for the package of the NVR can protect most accidental clashes during transportation. Then you can open the box to check the accessories.

Please check the items in accordance with the list. Finally you can remove the protective film of the NVR.

3.3 About Front Panel and Rear Panel

The model number in the stick on the bottom of NVR is very important; please check according to your purchase order.

The label in the rear panel is very important too. Usually we need you to represent the serial number when we provide the service after sales.

3.4 HDD Installation

Important:

Please turn off the power before you replace the HDD.

The pictures listed below for reference only.

For the first time install, please be aware that whether the HDDs have been installed or not.

You can refer to the Appendix for HDD space information and recommended HDD brand. **Usually we do not recommend the PC HDD.**

Please follow the instructions below to install hard disk.

3.4.1 NVR41/41-P/41-8P/41-W/21-S2/21-P-S2/21-8P-S2/41-4KS2/41-P-4KS2/41-8P-4KS2/1A-4P/1A-8P/21-4KS2/21-P-4KS2/21-8P-4KS2 Series



①. Loosen the screws of the bottom of the chassis.

② Place the HDD in accordance with the four holes in the bottom.

③ Turn the device upside down and then secure the screws firmly.



④ Connect the HDD cable and power cable to the HDD and the mainboard respectively.

⑤ Put the cover back and then fix the screws of the rear panel. The installation is complete.

3.4.2 NVR41H/41H-P/41H-8P/21HS-S2/21HS-P-S2/21HS-8P-S2/41HS-W-S2/41HS-4KS2/41HS-P-4KS2/41HS-8P-4KS2/1AHS/1AHS-4P/1AHS-8P/21HS-4KS2/21HS-P-4KS2/21HS-8P-4KS2 Series



①. Loosen the screws of the upper cover and side panel.

② Connect the one end of the HDD data cable and the power cable to the mainboard.

③ Connect the other end of the HDD data cable and the power cable to the HDD.

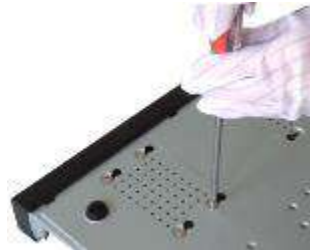

④ Place the HDD in accordance with the four holes on the bottom of the chassis.

⑤ Turn the device upside down; fix the screws to secure the HDD on the bottom of the chassis.

⑥ Put the cover in accordance with the clip and then fix the screws on the rear panel and side panel.

3.4.3 NVR42/42N/42-P/42-8P/42-16P/42-4K/42-8P-4K/52-4KS2/52-8P-4KS2/52-16P-4KS2/22-S2/22-P-S2/22-8P-S2/42-4KS2/42-P-4KS2/42-8P-4KS2/42-16P-4KS2/5224-24P-4KS2/2A16/22-4KS2/22-P-4KS2/22-8P-4KS2/52-16P-4KS2E Series



① Loosen the screws of the rear panel and side panel.

② Place the HDD in accordance with the four holes in the bottom.

③ Turn the device upside down and then secure the screws firmly. It is to fix the HDD on the chassis.



④ Connect the HDD cable and power cable.

⑤ Put the cover in accordance with the clip and then fix the screws on the rear panel and side panel.

3.4.4 NVR44/44-8P/44-16P/54-4KS2/54-16P-4KS2/44-4KS2/44-16P-4KS2/5424-24P-4KS2/54-16P-4KS2E Series



① Use the screwdriver to loose the screws of the rear panel and then remove the front cover.

② Put the HDD to the HDD bracket in the chassis and then line up the four screws to the four holes in the HDD. Use the screwdriver to fix the screws firmly to secure HDD on the HDD bracket



③ Connect to the HDD data cable to the main board and the HDD port respectively. Loosen the power cable of the chassis and connect another end of the power cable to the HDD port.

④ After connect the cable, put the front cover back to the device and then fix screws of the rear panel.

3.4.5 NVR48/48-16P/58-4KS2/58-16P-4KS2/48-4KS2/48-16P-4KS2/52-16P-4KS2E Series



① Use the screwdriver to loose the screws of the rear panel and then remove the front cover.



② Put the HDD to the HDD bracket in the chassis and then line up the four screws to the four holes in the HDD. Use the screwdriver to fix the screws firmly to secure HDD on the HDD bracket



③ Connect to the HDD data cable to the main board and the HDD port respectively. Loosen the power cable of the chassis and connect another end of the power cable to the HDD port.



④ After connect the cable, put the front cover back to the device and then fix screws of the rear panel.

3.4.6 NVR42V-8P Series

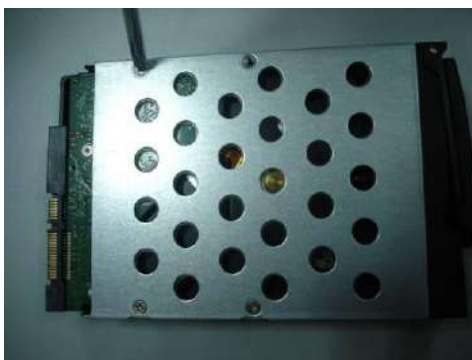

① Use 4 screws to secure the HDD



② Put the HDD to the HDD box at the front.



③ Pull the HDD knob up when you put the HDD into the box in case the knob buckle may strike the front panel.



④ Put the knob back after you insert the HDD to the SATA board.

3.5 CD-ROM Installation

Please follow the steps listed below.



① Open top cover and then remove the HDD bracket



② Take off the bottom of the HDD bracket and CD-ROM bracket.



③ Fix the CD-ROM bracket at the HDD bracket.



④ Install a pair of the CD-ROM bracket. Please make sure the reverse side is secure too.



⑤ Install SATA burner. Line up the SATA burner to the hole positions.



⑥ User screwdriver to fix the screws.



⑦ Put the bracket back. Please adjust the CD-ROM to the proper position so that the button of the front panel is directly facing the pop-up button of the CD-ROM.

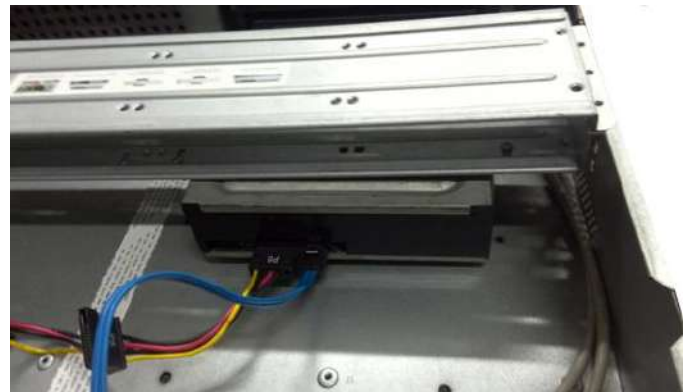

⑧ Connect the SATA cable and power wire.



⑨ Secure the HDD bracket and put the top cover back.

3.6 Connection Sample

3.6.1 NVR41/41-P/41-8P/41-W/21-S2/21-P-S2/21-8P-S2/41-4KS2/41-P-4KS2/41-8P-4KS2/1A-4P/1A-8P/21-4KS2/21-P-4KS2/21-8P-4KS2 Series

Please refer to Figure 3-1 for connection sample.
The following figure for reference only.

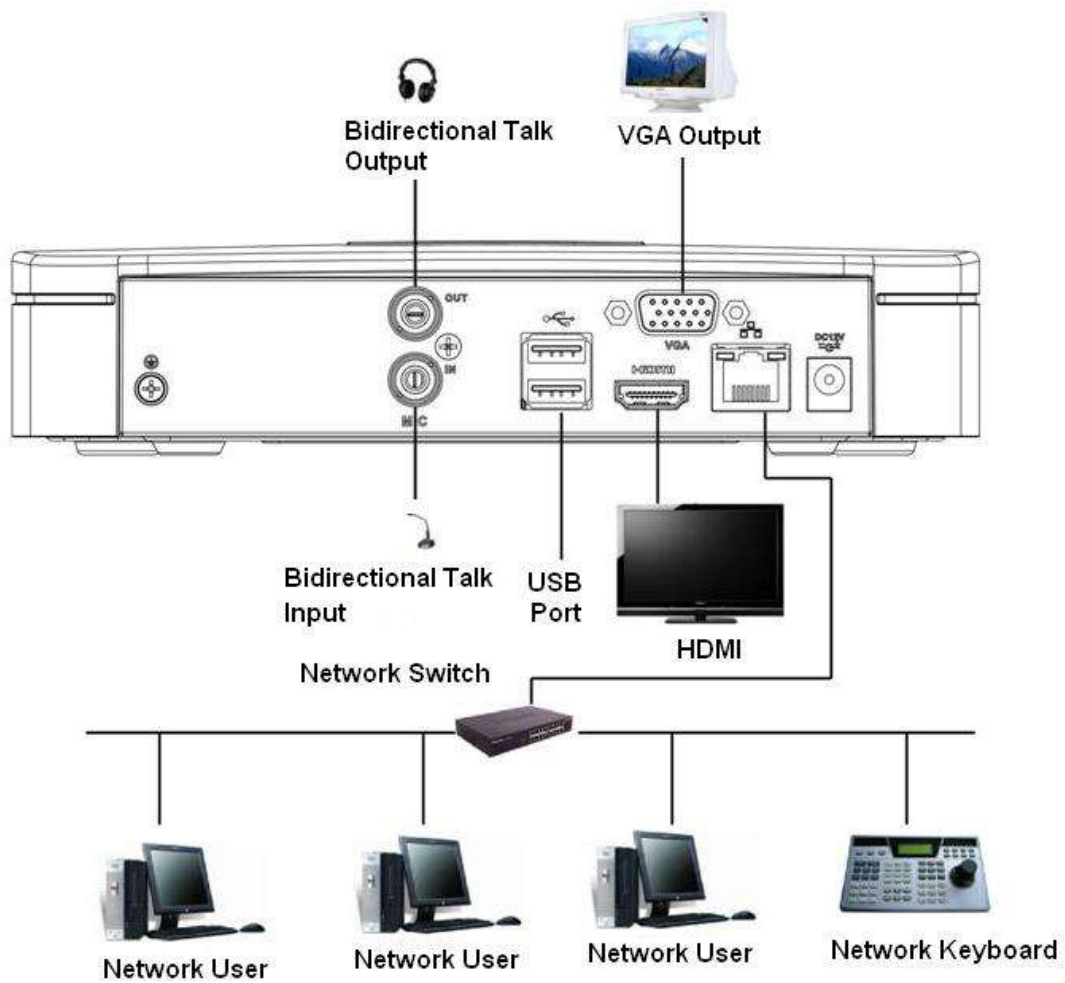

Figure 3-1

3.6.2 NVR41H/41H-P/41H-8P Series

Please refer to Figure 3-2 for connection sample.

The following figure for reference only.

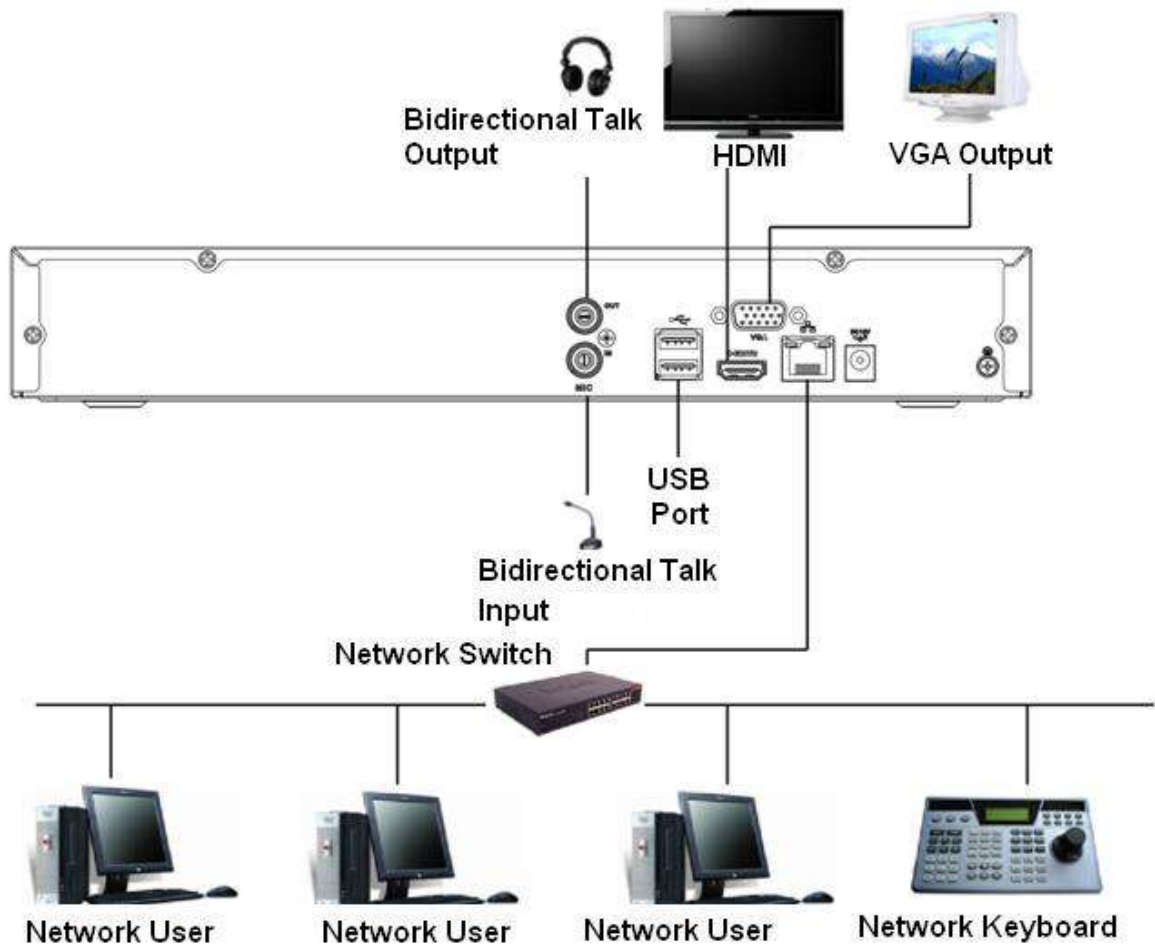

Figure 3-2

3.6.3 NVR41HS-W-S2 Series

Please refer to Figure 3-3 for connection sample.

The following figure for reference only.

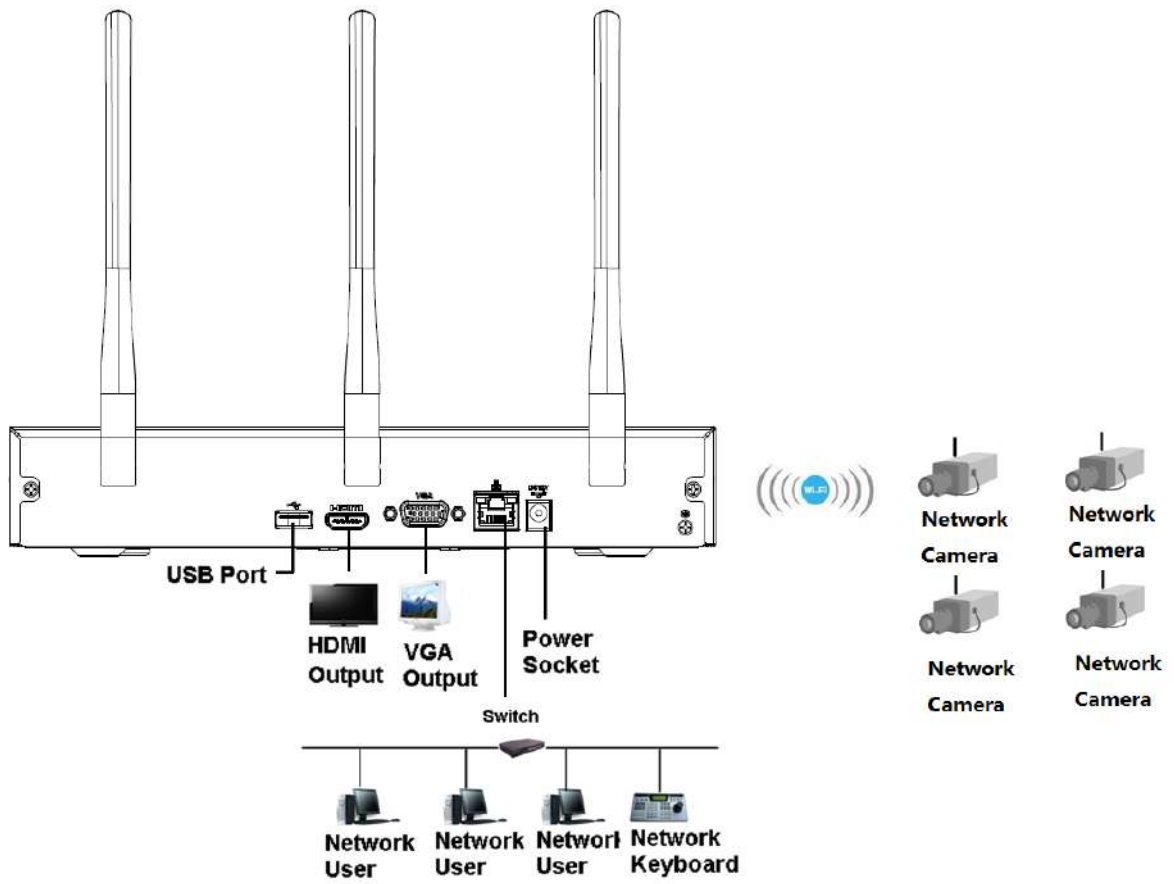

Figure 3-3

3.6.4 NVR21HS-S2/21HS-P-S2/21HS-8P-S2/41HS-4KS2/41HS-P-4KS2/41HS-8P-4KS2/1AHS/1AHS-4P/1AHS-8P/21HS-4KS2/21HS-P-4KS2/21HS-8P-4KS2 Series

Please refer to Figure 3-4 for connection sample.

The following figure for reference only.

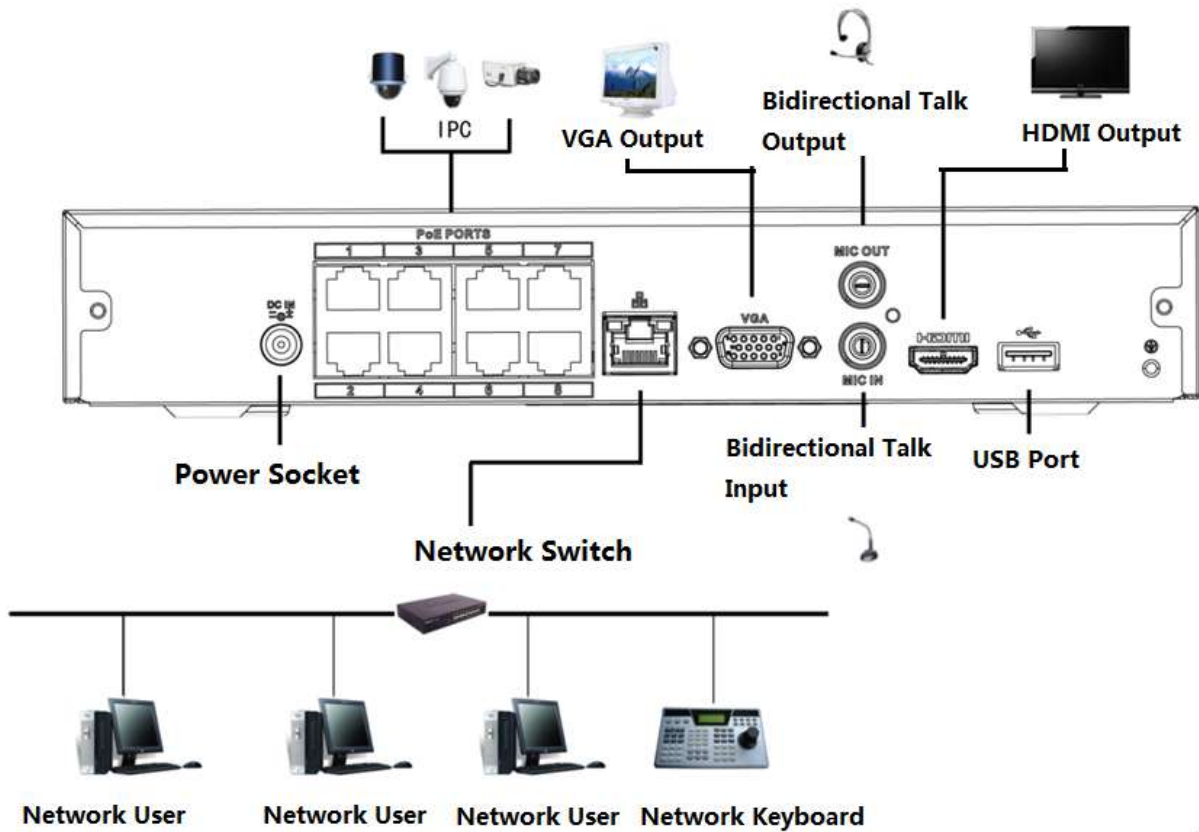

Figure 3-4

3.6.5 NVR22-S2/22-P-S2/22-8P-S2/2A16/22-4KS2/22-P-4KS2/22-8P-4KS2 Series

Please refer to Figure 3-5 for connection sample.

The following figure for reference only.

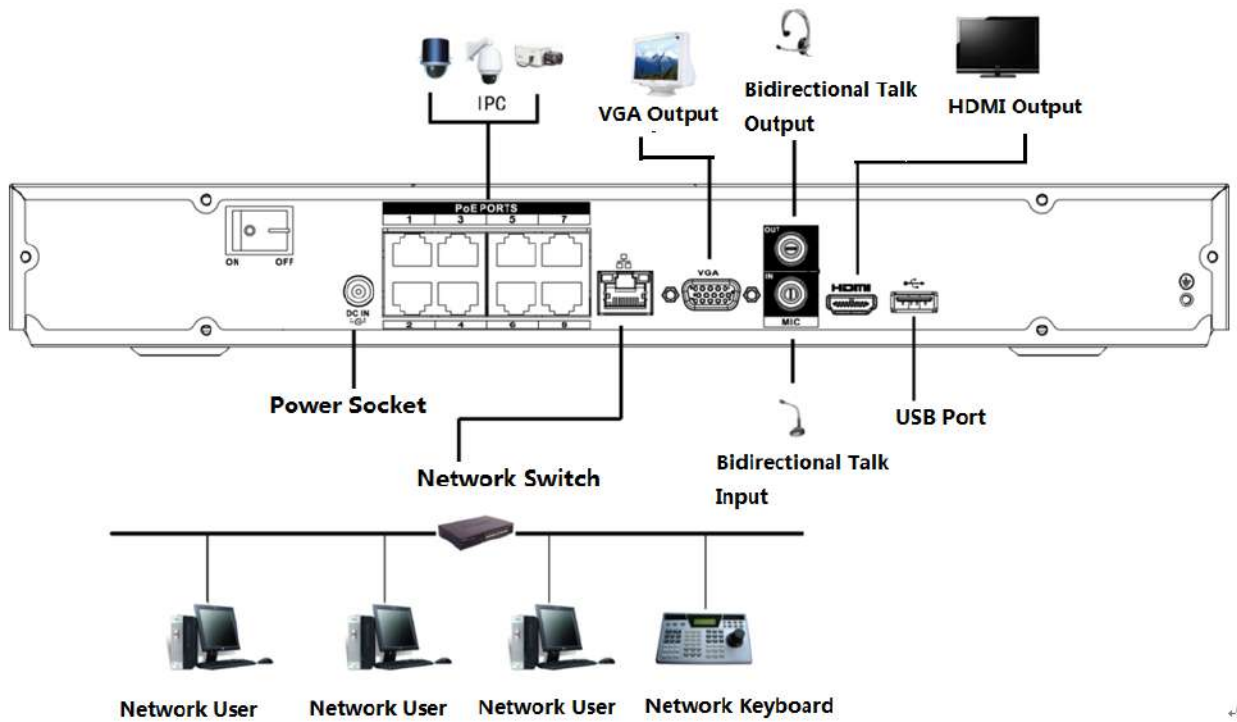

Figure 3-5

3.6.6 NVR42N Series

Please refer to Figure 3-6 for connection sample.

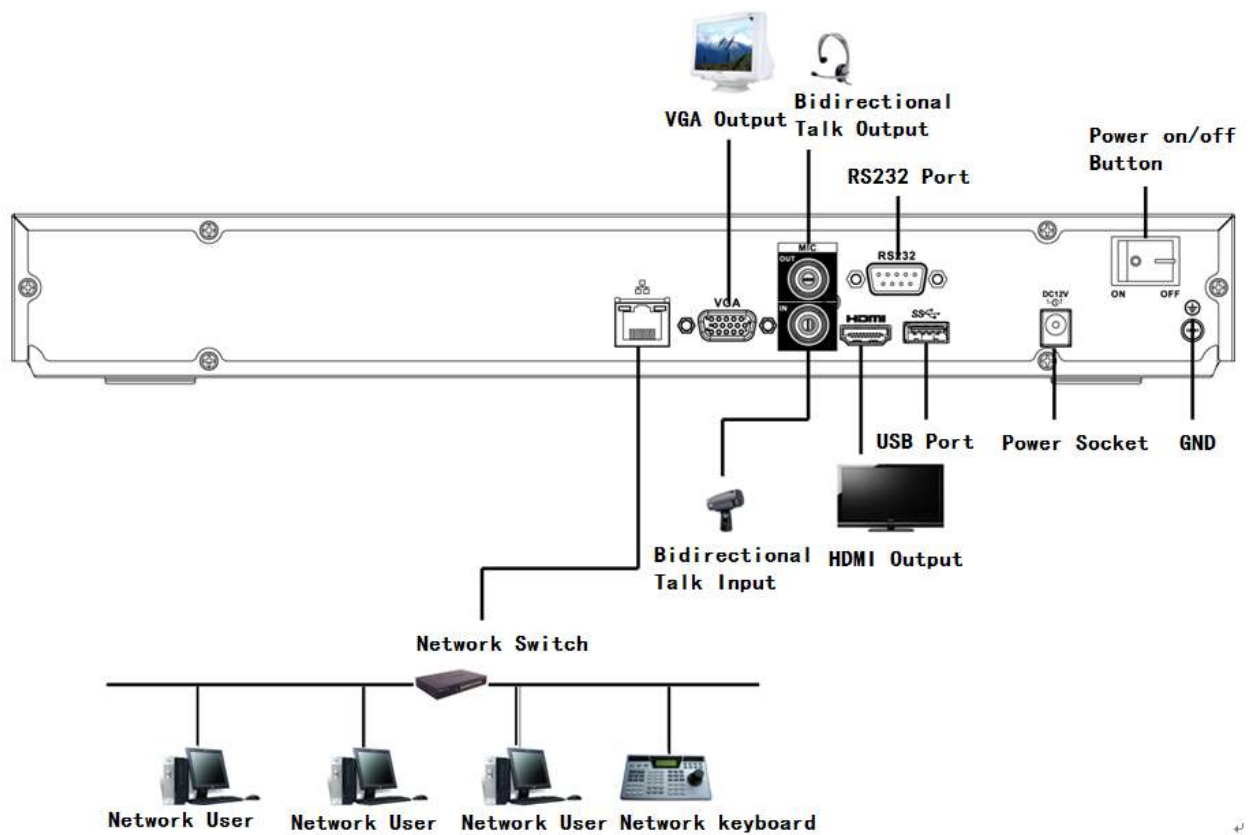

Figure 3-6

3.6.7 NVR42/42-P/42-8P/42-16P/52-4KS2/52-8P-4KS2/52-16P-4KS2/5224-24P-4KS2/52-16P-4KS2E Series

Please refer to Figure 3-7 for connection sample.
The following figure for reference only.

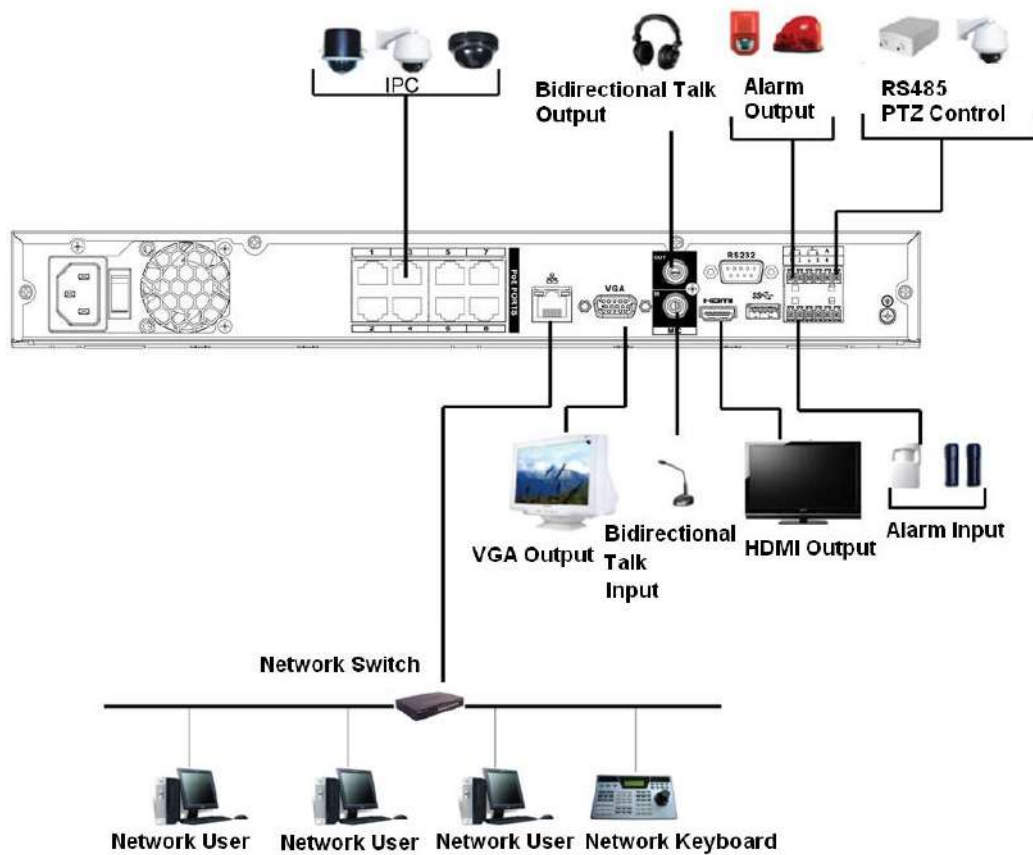

Figure 3-7

3.6.8 NVR42-8P-4K/42-4KS2/42-P-4KS2/42-8P-4KS2/42-16P-4KS2 Series

Please refer to Figure 3-8 for connection sample.
The following figure for reference only.

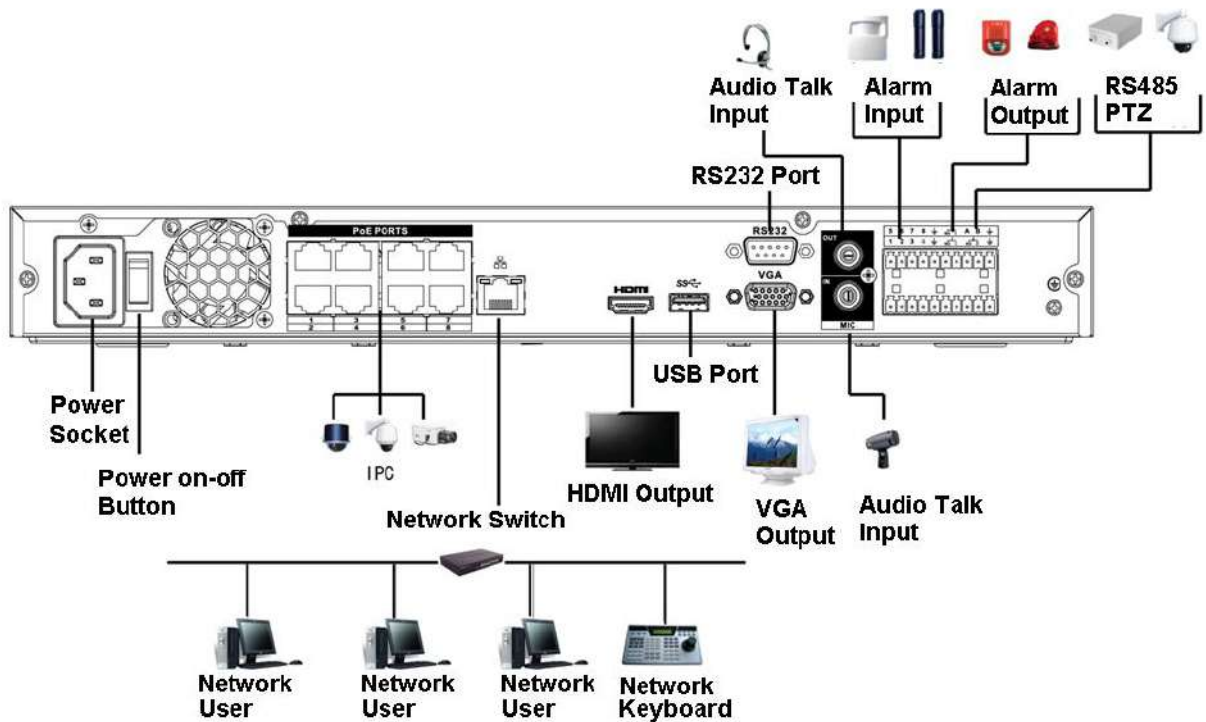

Figure 3-8

3.6.9 NVR54-4KS2/54-16P-4KS2/58-4KS2/58-16P-4KS2/5424-24P-4KS2/54-16P-4KS2E /5816P-4KS2E Series

Please refer to Figure 3-8 for connection sample.

The following figure for reference only.

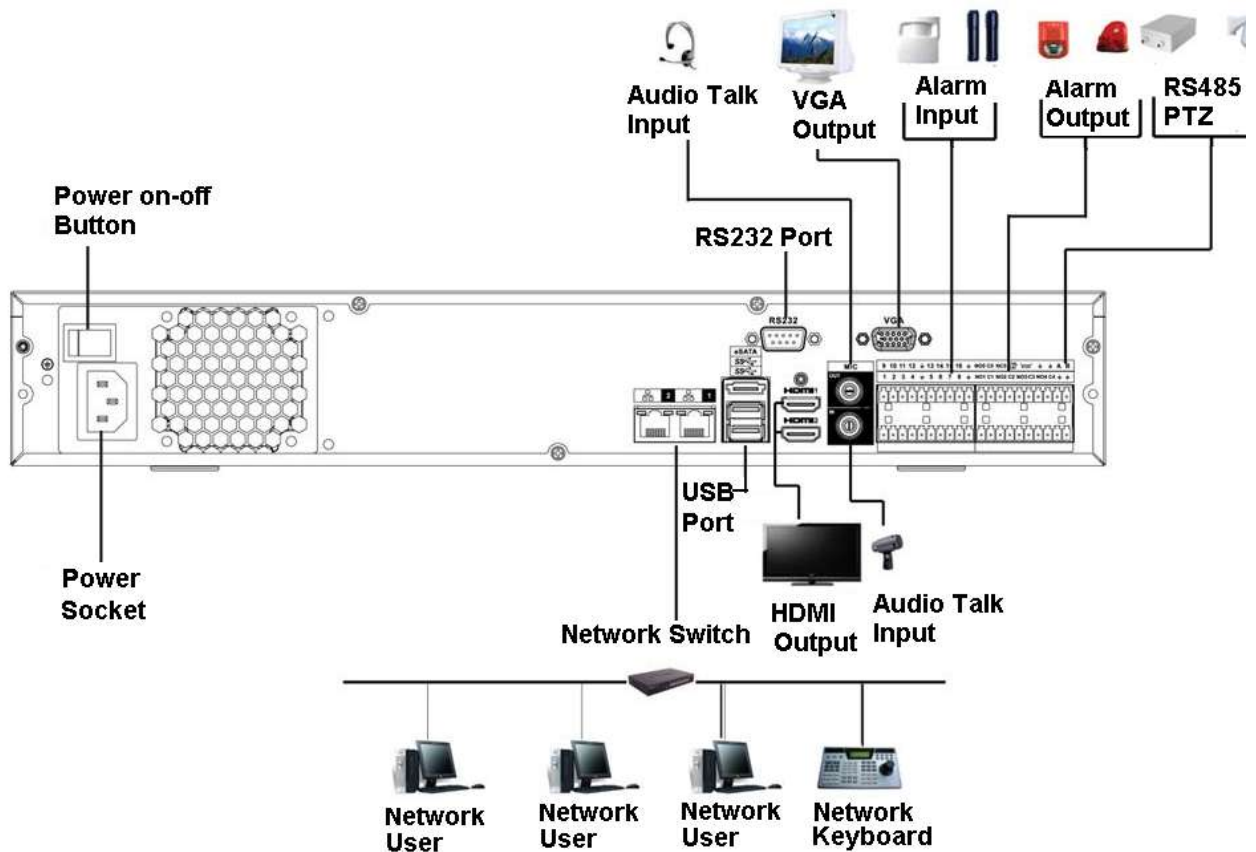

Figure 3-9

3.6.10 NVR44/44-8P/44-16P/44-4KS2/44-16P-4KS2 Series

Please refer to Figure 3-10 for connection sample.

The following figure for reference only.

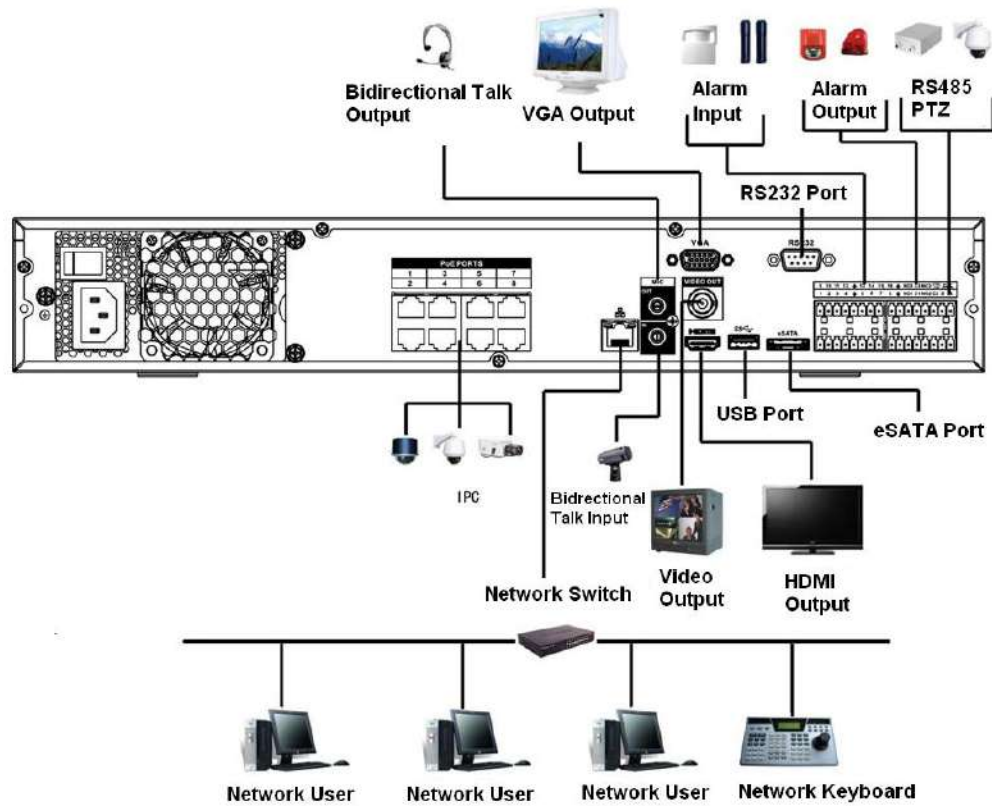

Figure 3-10

3.6.11 NVR48/48-16P/48-4KS2/48-16P-4KS2 Series

Please refer to Figure 3-11 for connection sample.

The following figure for reference only.

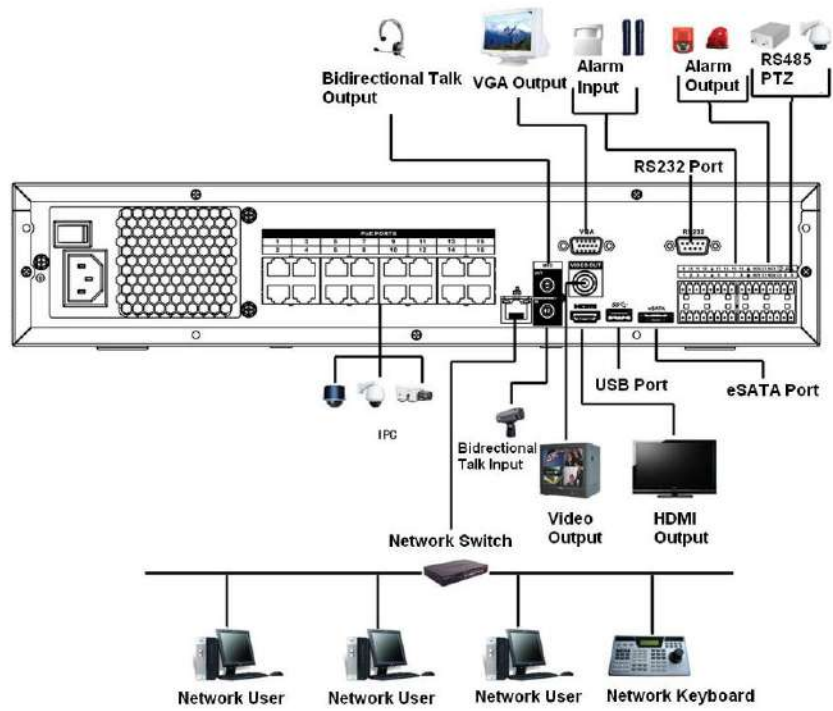

Figure 3-11

3.6.12 NVR42V-8P Series

Please refer to Figure 3-12 for connection sample.

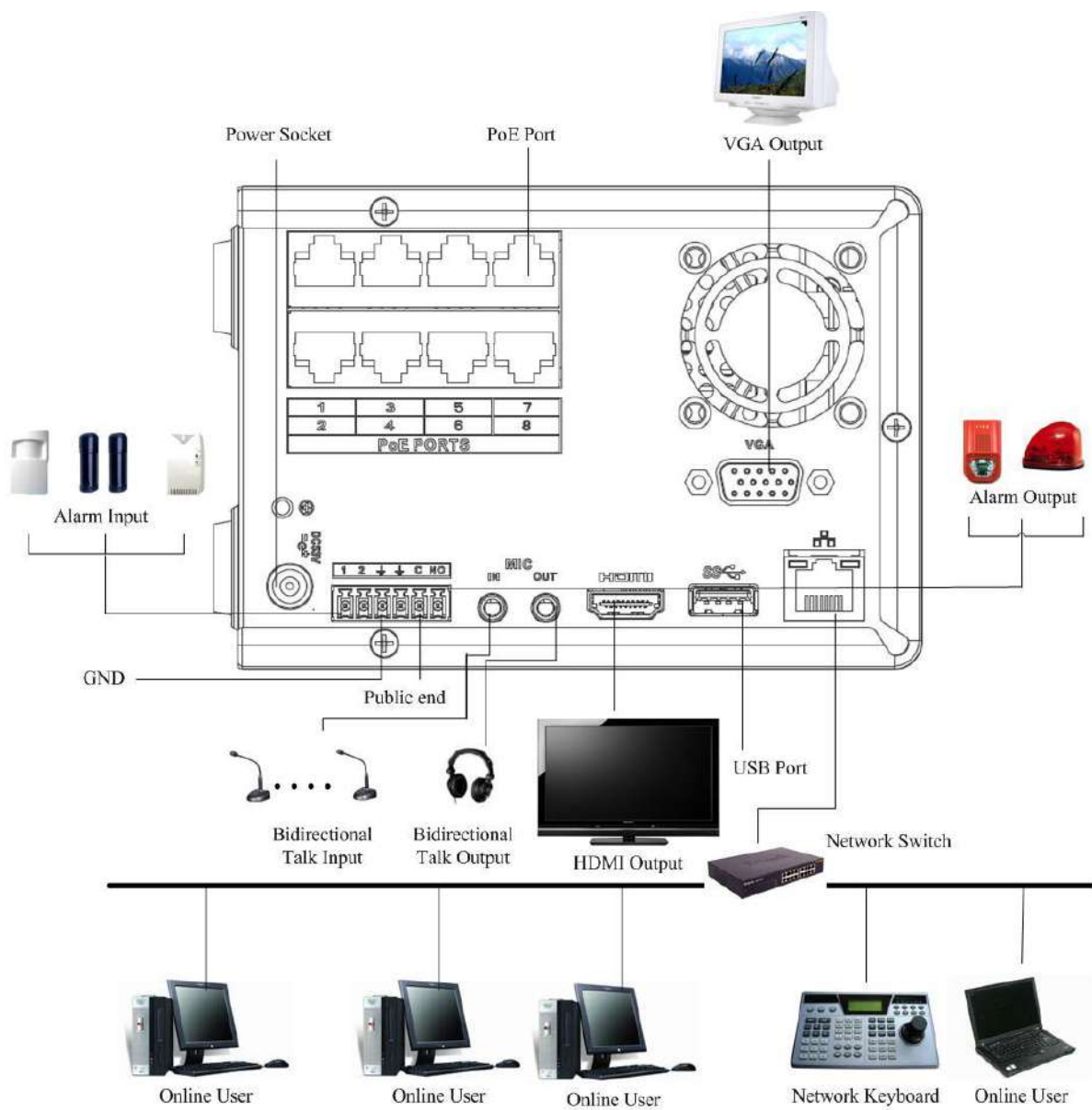

Figure 3-12

4 Local Basic Operation

Note

Slight difference may be found on the user interface. The following figures for reference only.

4.1 Getting Started

4.1.1 Boot up and Shut down

4.1.1.1 Boot up



Warning

Before the boot up, please make sure:

- For device security, please connect the NVR to the power adapter first and then connect the device to the power socket.
- The rated input voltage matches the device power on-off button. Please make sure the power wire connection is OK. Then click the power on-off button.
- Always use the stable current, if necessary UPS is a best alternative measure.

Please follow the steps listed below to boot up the device.

Step 1 Connect the device to the monitor and then connect a mouse.

Step 2 Connect power cable.

Step 3 Click the power button at the front or rear panel and then boot up the device. After device booted up, the system is in multiple-channel display mode by default.

4.1.1.2 Shutdown

Note

- When you see corresponding dialogue box “System is shutting down...” Do not click power on-off button directly.
- Do not unplug the power cable or click power on-off button to shutdown device directly when device is running (especially when it is recording.)

There are three ways for you to log out.

- a) Main menu (**RECOMMENDED**)

From Main Menu->Shutdown, select shutdown from dropdown list.

Click OK button, you can see device shuts down.

- b) From power on-off button on the front panel or remote control.

Press the power on-off button on the NVR front panel or remote control for more than 3 seconds to shut down the device.

- c) From power on-off button on the rear panel.

4.1.2 Device Initialization

If it is your first time to use the device, please set a login password of **admin** (system default user). You can select to use unlock pattern to login or not at your own choosing.

Note

For your device safety, please keep your login password of **admin** well after the initialization steps, and change the password regularly.

Please follow the steps listed below.

Step 1 Boot up NVR.

Device displays device initialization interface. See Figure 4-1.

The screenshot shows a web-based interface for device initialization. At the top, there's a title bar 'Device Initialization' and three numbered steps: '1 Enter Password' (active), '2 Unlock Pattern', and '3 Password Protection'. The main area contains a form with the following fields: 'Username' (pre-filled with 'admin'), 'Password' (empty), 'Confirm Password' (empty), and 'Prompt Question' (empty). Below the password field, there is a text instruction: 'It is 8 to 32-digit containing letter(s), number(s), symbol(s). It contains at least two types.' A 'Next' button is located at the bottom right of the form.

Figure 4-1

Step 4 Set login password of **admin**.

- User name: The default user name is **admin**.
- Password/confirm password: The password ranges from 8 to 32 digits. It can contain letters, numbers and special characters (excluding “'” , “”” , “;” , “:” , “&”). The password shall contain at least two categories. Usually we recommend the strong password.
- Prompt question: If you set the prompt question here. On the login interface, move your mouse on , device can display the corresponding prompt question for you to remind the password.



WARNING

STRONG PASSWORD RECOMMENDED-For your device own safety, please create a strong password of your own choosing. We also recommend you change your password periodically especially in the high security system.

Step 5 Click Next, device goes to the following interface. See Figure 4-2.

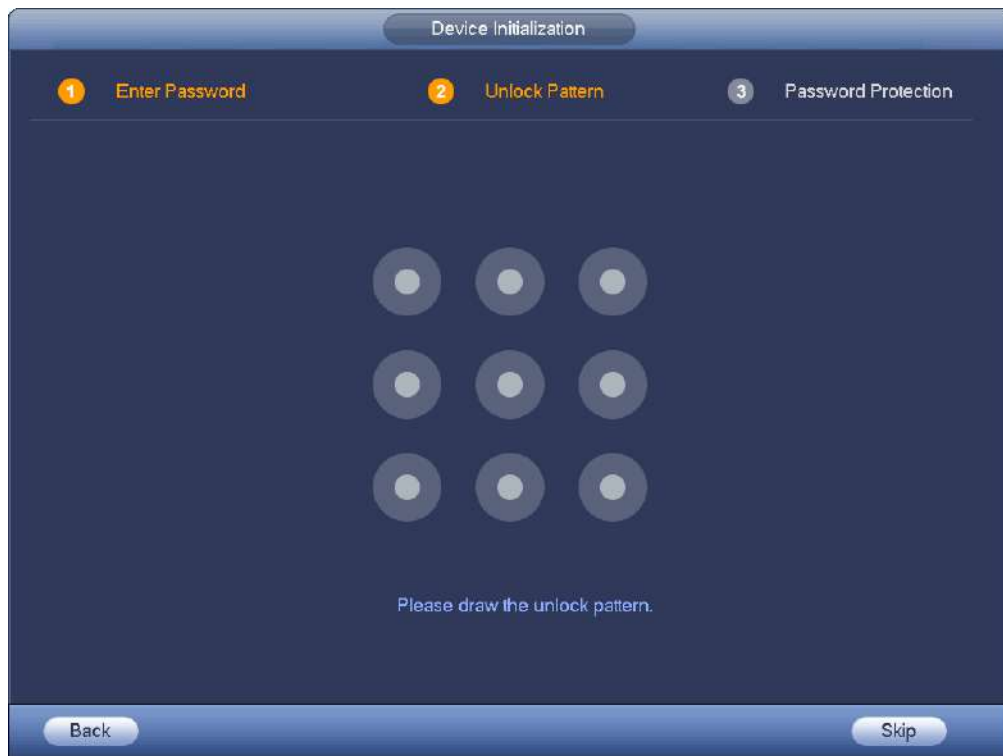

Figure 4-2

Step 6 Set unlock pattern.

After set unlock pattern, device goes to password protection interface. See Figure 4-3.

 **Note**

- Device adopts unlock pattern to login by default if you have set pattern here. If there is no unlock pattern, please input the password to login.
- Click Skip if there is no need to set unlock pattern.

Figure 4-3

Step 7 Set security questions.

 **Note**

- After setting the security questions here, you can use the email you input here or answer the security questions to reset **admin** password. Refer to chapter 4.1.3 Reset password for detailed information.
- Cancel the email or security questions box and then click Next button to skip this step.
- Email: Input an email address for reset password purpose. In case you forgot password in the future, input the security code you got on the assigned email to reset the password of admin. If you have not input email here or you need to update the email information, please go to the main menu->Setting->System->Account to set. Refer to chapter 4.10.1 Account for detailed information.
- Security question: Set security questions and corresponding answers. Properly answer the questions to reset admin password. In case you have not input security question here or you need to update the security question information, please go to the main menu->Setting->System->Account->Security question to set. Refer to chapter 4.10.1.3 Security question for detailed information.

 **Note**

If you want to reset password by answering security questions, please go to the local menu interface.

Step 8 Click OK to complete the device initialization setup.

Device goes to startup wizard interface. Refer to chapter 4.1.4 Quick Settings for detailed information.

4.1.3 Reset Password

If you forgot **admin** password, you can reset the password by email or by answering the security questions.

Please follow the steps listed below.

Step 1 Go to the device login interface. See Figure 4-4 or Figure 4-5. .

- If you have set unlock pattern, device displays unlock pattern login interface. See Figure 4-4. Click “Forgot unlock pattern”, device goes to Figure 4-5.
- If you have not set unlock pattern, device displays password interface. See Figure 4-5.

Note

Click Switch user button, NVR goes to general user login interface. The default user name is **admin**. Click the user name and then select a user from the dropdown list; you can login via other account.

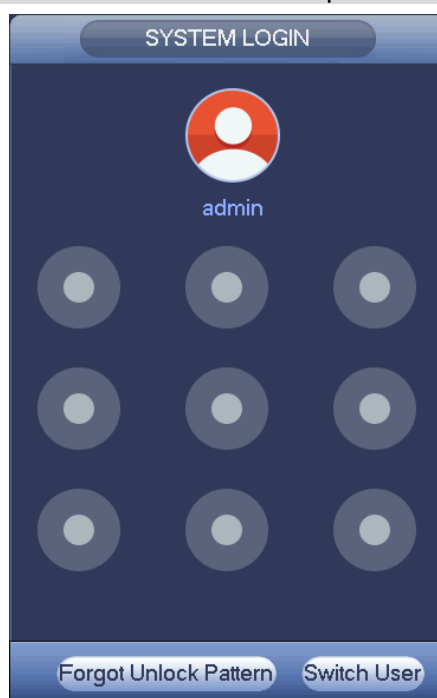

Figure 4-4



Figure 4-5

Step 2 Click .

- If you have not input email address information when you are initializing the device, the interface is shown as in Figure 4-6. Please input an email address and then click Next button, devices goes to Figure 4-7.
- If you have input email when you are initializing the device, device goes to Figure 4-7.

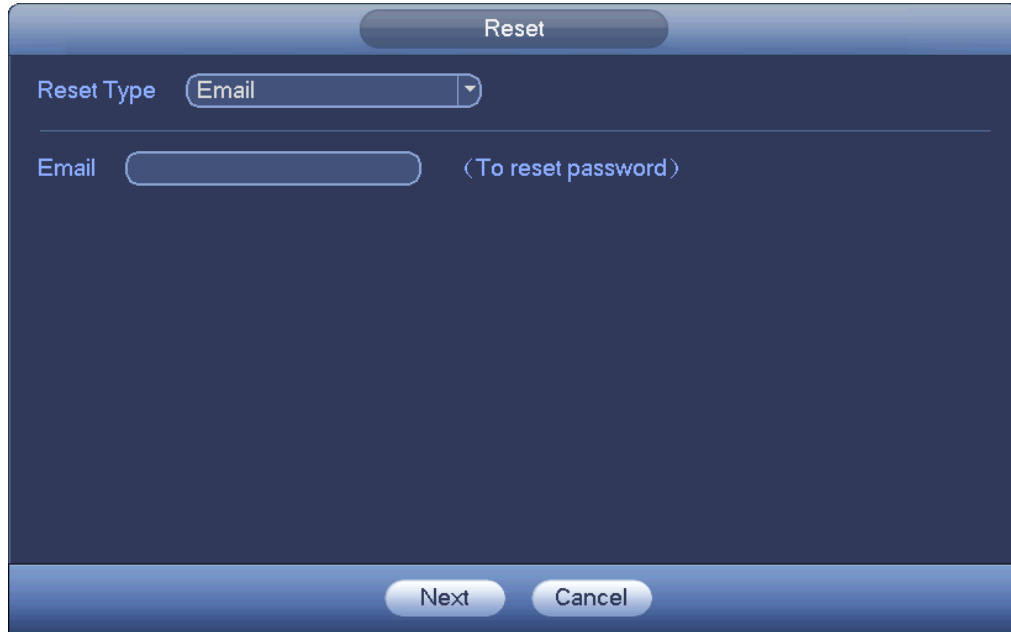

Figure 4-6

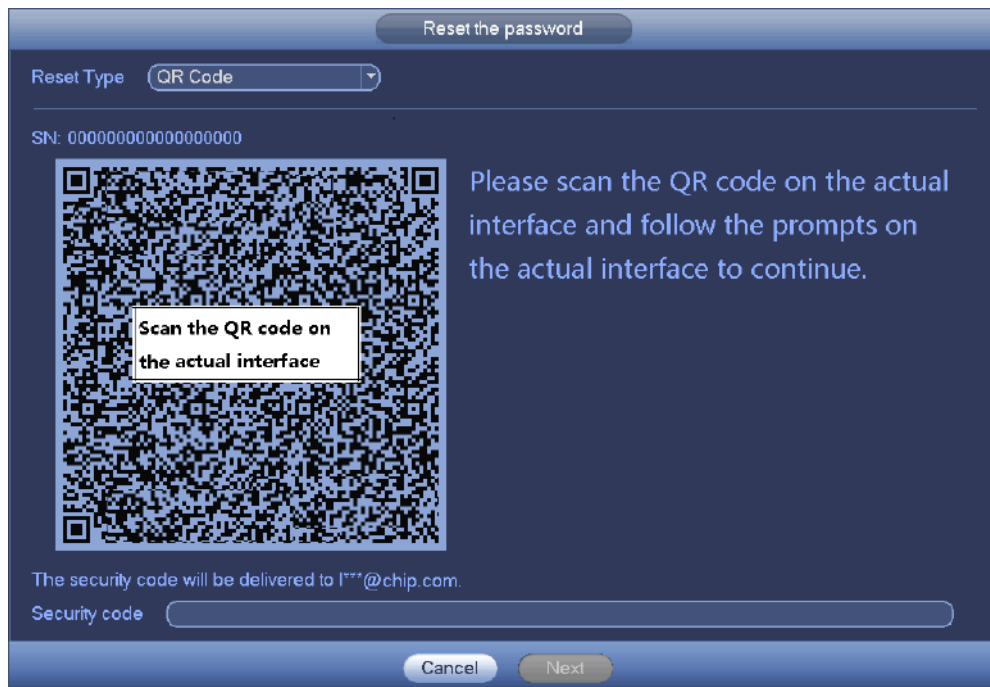

Figure 4-7

Step 3 Reset login password.

There are two ways to reset the password: Scan QR code and reset by email/security questions (local menu only)

- Email

In Figure 4-7, follow the prompts on the interface to scan the QR code, and then input the security code you get via the assigned email.



Warning

- ✧ For the same QR code, max scan twice to get two security codes. Refresh the QR code if you want to get security code again.
- ✧ The security code on your email is only valid for 24 hours.

- Security questions

In Figure 4-6., select security question from the drop down list. Device displays security question interface. See Figure 4-8. Please input the correct answers here.

The screenshot shows a 'Reset' interface with a dark blue background. At the top, there is a 'Reset' button. Below it, the 'Reset Type' is set to 'Security Question'. There are three security questions, each with a dropdown menu and a text input field for the answer:

- Question 1: What is your favorite children's book? (Answer field)
- Question 2: What was the first name of your first boss? (Answer field)
- Question 3: When did you last enroll? (Answer field)

At the bottom, there are 'Next' and 'Cancel' buttons.

Figure 4-8

Step 4 Click Next button.

Device displays reset password interface. See Figure 4-9.

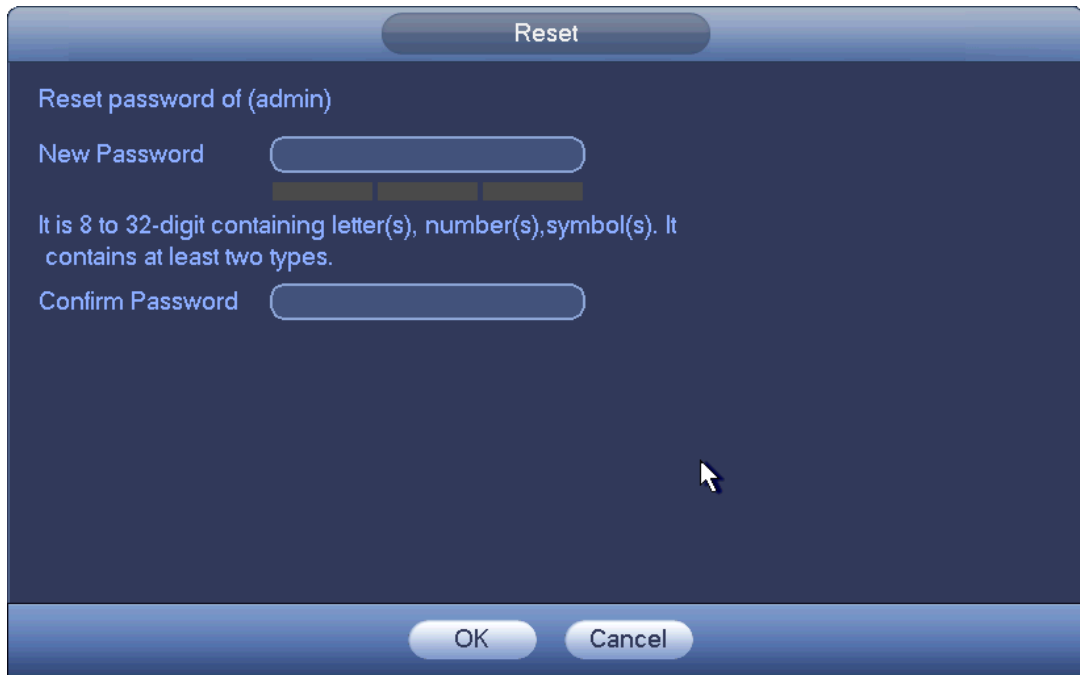

Figure 4-9

Step 5 Input new password and then confirm.



WARNING

STRONG PASSWORD RECOMMENDED-For your device own safety, please create a strong password of your own choosing. The password shall be at least 8-digit containing at least two types of the following categories: letters, numbers and symbols. We also recommend you change your password periodically especially in the high security system.

Step 6 Click OK button to complete the setup.

4.1.4 Quick Settings

After you successfully initialize the device, it goes to startup wizard. Here you can quickly configure your device. It includes smart add, general setup, basic network setup, camera registration, P2P, and schedule interface.



Note

- Once the power is off during the quick settings process, you need to go through startup wizard again when the device boot up the next time.
- After completing all items on the startup wizard, the startup wizard automatically hides when the device boot up the next time.

Please follow the steps listed below.

Boot up the device and complete the device initialization. Device goes to startup wizard. See Figure 4-10.

- Enable smart add function, device can automatically search and add the remote device on the LAN. Refer to chapter 4.1.4.4 Smart add for detailed information.
- Select auto check, device automatically checks there is new applications or not every day.

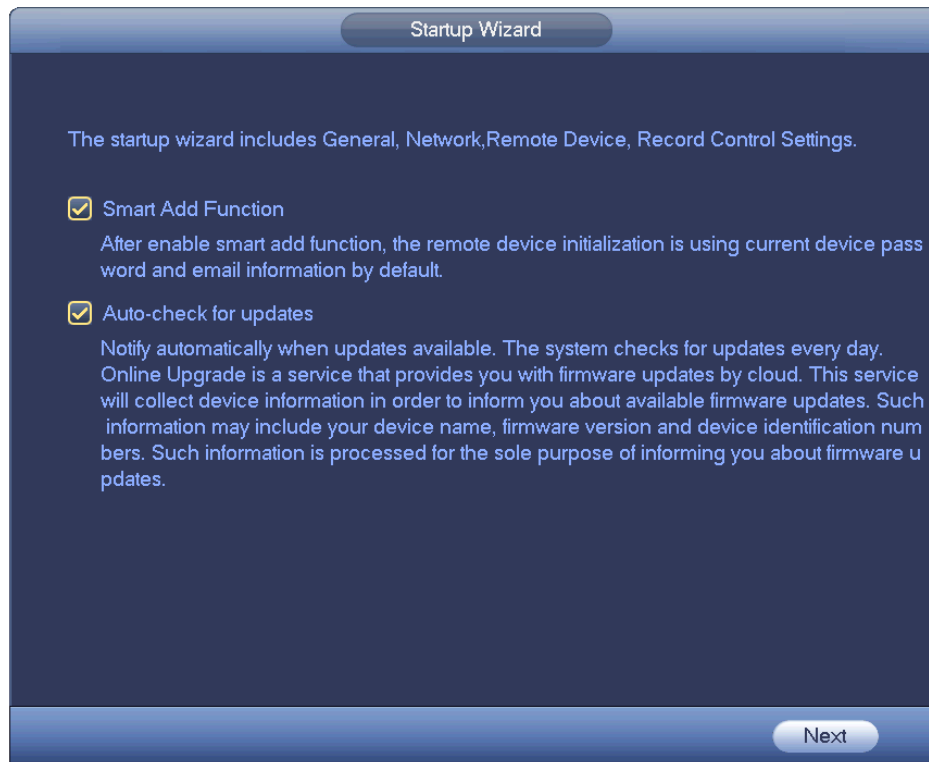

Figure 4-10

 **Note**

Smart add and auto check function is for some series products. Refer to your actual interface for detailed information.

4.1.4.1 General

It is to set NVR basic information such as system date, holiday and etc.

4.1.4.1.1 General

It is to set device basic information such as device name, serial number and etc.

Please follow the steps listed below.

Step 1 Click Next button,

Enter General interface.

Step 2 Click General button.

The interface is shown as below. See Figure 4-11.

 **Note**

From Main menu->Setting->System->General->General, you can go to the general interface.

Step 3 Set parameters.

- Device ID: Please input a corresponding device name here.
- Device No: When you are using one remote control (not included in the accessory bag) to control several NVRs, you can give a name to each NVR for your management.
- Language: System supports various languages: Chinese (simplified), Chinese (Traditional), English, Italian, Japanese, French, Spanish (All languages listed here are optional. Slight difference maybe found in various series.)
- Video standard: There are two formats: NTSC and PAL.

- HDD full: Here is for you to select working mode when hard disk is full. There are two options: stop recording or rewrite old files.
- Pack duration: Here is for you to specify record duration. The value ranges from 1 to 120 minutes. Default value is 60 minutes.
- Realtime play: It is to set playback time you can view in the preview interface. The value ranges from 5 to 60 minutes.
- Auto logout: Here is for you to set auto logout interval once login user remains inactive for a specified time. Value ranges from 0 to 60 minutes.
- Monitor channels when logout: Here you can set channels you want to view when your account has logged out. Click the button and then cancel the channel name box, you need to login to view the corresponding video. The channel window displays  in preview interface.
- Navigation bar: Check the box here, system displays the navigation bar on the interface.
- IPC Time Sync: You can input an interval here to synchronize the NVR time and IPC time.
- Startup wizard: Once you check the box here, system will go to the startup wizard directly when the system restarts the next time. Otherwise, it will go to the login interface.
- Mouse sensitivity: You can set double click speed via dragging the slide bard. You can Click Default button to restore default setup.



Figure 4-11

Step 4 Click Apply button to save settings.

4.1.4.1.2 Date and Time

Here you can set device time. You can enable NTP (Network Time Protocol) function so that the device can sync time with the NTP server.

Step 1 Click Date and time button. See Figure 4-12.

 **Note**

From Main menu->Setting->System->General->Date and time, you can go to the date and time interface.

- System time: Here is for you to set system time
- Date format: There are three types: YYYY-MM-DD: MM-DD-YYYYY or DD-MM-YYYYY.
- Date separator: There are three denotations to separate date: dot, beeline and solidus.
- DST: Here you can set DST time and date by week or by date. Please enable DST function and then select setup mode. Please input start time and end time and click Save button.
- Time format: There are two types: 24-hour mode or 12-hour mode.
- NTP: It is to set NTP server, port and interval.



Warning

- ✧ System time is very important; do not modify time casually unless there is a must!
- ✧ Before your time modification, please stop record operation first!

Figure 4-12

Step 5 Click Apply button to save settings.

4.1.4.1.3 Holiday

Here you can add, edit, delete holiday. After you successfully set holiday information, you can view holiday item on the record and snapshot period.

Step 1 Click Holiday button. See Figure 4-13.

 **Note**

From Main menu->Setting->System->General->Holiday, you can go to the holiday interface.

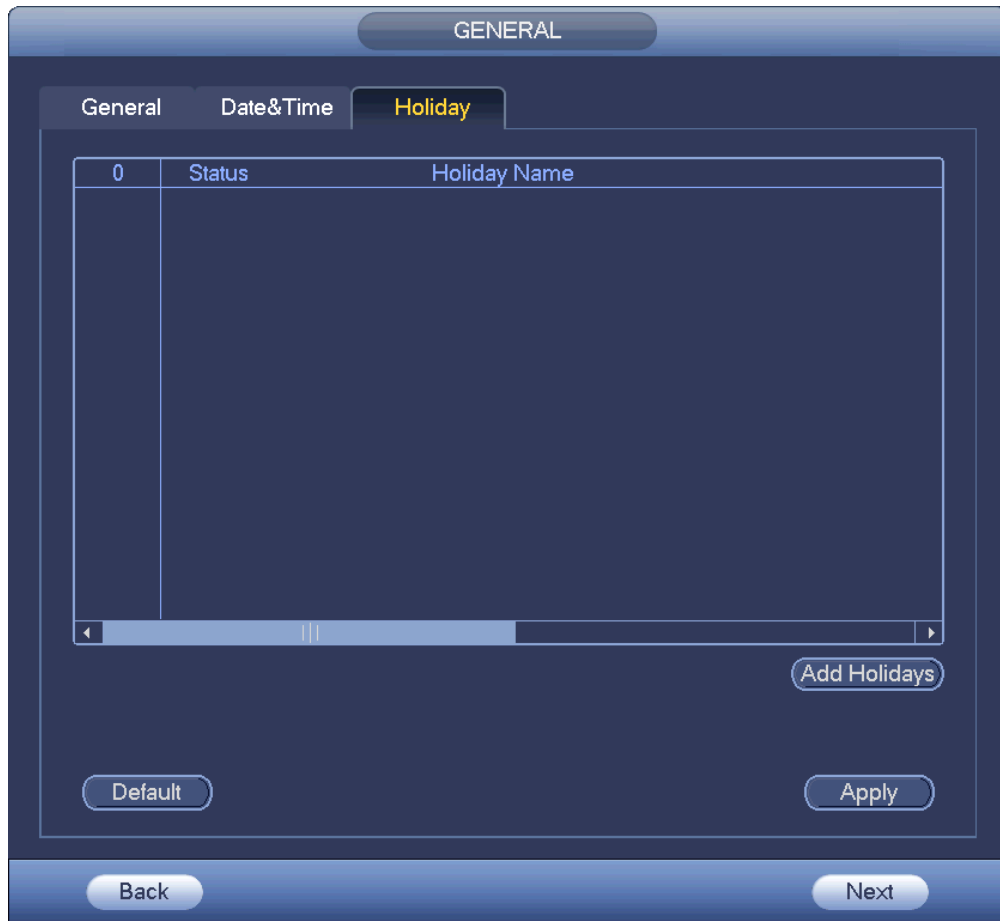

Figure 4-13

Step 2 Click Add new holiday button, device displays the following interface. See Figure 4-14.



Figure 4-14

Step 3 Set holiday name, repeat mode and holiday mode.



 **Note**

Click Add more to add new holiday information.

Step 4 Click Add button, you can add current holiday to the list.

 **Note**

✧ Click the dropdown list of the state; you can enable/disable holiday date.

✧ Click  to change the holiday information. Click  to delete current date.

Step 5 Click Apply button to save settings.

4.1.4.2 Basic Network Settings

Set device IP address, DNS (Domain Name System) information.

Preparation

Make sure the device has properly connected to the network.

Step 1 Click Next button, device goes to TCP/IP interface. See Figure 4-15.

 **Note**

✧ From Main menu->Setting->Network->TCP/IP, you can go to the TCP/IP interface.

✧ Different series products have different Ethernet adapter amount and type. Please refer to the actual product.



Figure 4-15

Step 2 Click , device display edit interface. See Figure 4-16.

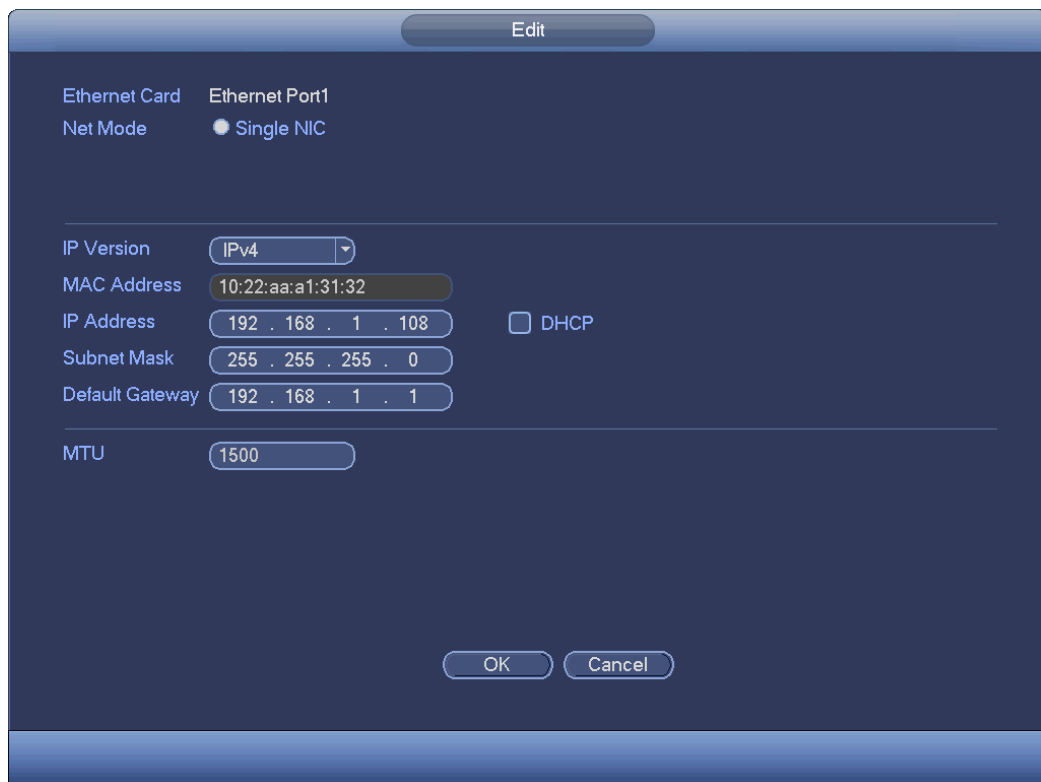

Figure 4-16

Step 3 Set parameters.

- Network Mode : Includes multiple access, fault tolerance, and load balancing
- ✧ Multiple-address mode: eth0 and eth1 operate separately. You can use the services such as HTTP, RTP service via etho0 or the eth1. Usually you need to set one default card (default setup is etho) to request the auto network service form the device-end such as DHCP, email, FTP and etc. In multiple-address mode, system network status is shown as offline once one card is offline.
- ✧ Network fault-tolerance: In this mode, device uses bond0 to communicate with the external devices. You can focus on one host IP address. At the same time, you need to set one master card. Usually there is only one running card (master card).System can enable alternate card when the master card is malfunction. The system is shown as offline once these two cards are both offline. Please note these two cards shall be in the same LAN.
- ✧ Load balance: In this mode, device uses bond0 to communicate with the external device. The eth0 and eth1 are both working now and bearing the network load. Their network load are general the same. The system is shown as offline once these two cards are both offline. Please note these two cards shall be in the same LAN.
- Main Network Card: Please select eth0/eth1 (optional).after enable multiple access function.

 **Note**

The dual-Ethernet port series support the above three configurations and supports functions as multiple-access, fault-tolerance and load balancing.

- MAC address: The host in the LAN can get a unique MAC address. It is for you to access in the LAN. It is read-only.
- IP address: Here you can use up/down button (▲▼) or input the corresponding number to input IP address. Then you can set the corresponding subnet mask the default gateway.

- Default gateway: Here you can input the default gateway. Please note system needs to check the validity of all IPv6 addresses. The IP address and the default gateway shall be in the same IP section. That is to say, the specified length of the subnet prefix shall have the same string.
- DHCP: It is to auto search IP. When enable DHCP function, you cannot modify IP/Subnet mask /Gateway. These values are from DHCP function. If you have not enabled DHCP function, IP/Subnet mask/Gateway display as zero. You need to disable DHCP function to view current IP information. Besides, when PPPoE is operating, you cannot modify IP/Subnet mask /Gateway.
- MTU: It is to set MTU value of the network adapter. The value ranges from 1280-7200 bytes. The default setup is 1500 bytes.
- Transfer mode: Here you can select the priority between fluency/video qualities.

Step 4 Click OK to NIC settings.
Device goes back to TCP/IP interface.

 **Note**

Click  to cancel NIC bonding. Please note device needs to reboot to activate new setup.

Step 5 Set network parameters.

- IP Version: There are two options: IPv4 and IPv6. Right now, system supports these two IP address format and you can access via them.
- Preferred DNS server: DNS server IP address.
- Alternate DNS server: DNS server alternate address.
- Default Network Card: Please select eth0/eth1/bond0(optional) after enable multiple-access function.
- LAN download: System can process the downloaded data first if you enable this function. The download speed is 1.5X or 2.0X of the normal speed.

 **Note**

- For IPv6 version, the IP address, default gateway, preferred DNS; alternate DNS is 128-digit. Please fill in all items here.
- This function is for some series product only.

Step 6 Click Next to complete the settings.

4.1.4.3 P2P

Click Next button, you can set P2P function. Scan the QR code, download the App to the cell phone, you can use the smart phone to add the device.

- Scan the QR code on the actual interface to download the cell phone app. Register an account and then use.
- Go to the www.easy4ip.com to register an account and use the SN to add a device. Refer to the P2P operation manual for detailed information.



Before use the P2P function, make sure the NVR has connected to the WAN.

Please follow the steps listed below.

Step 1 Click Next button.

Enter P2P interface. See Figure 4-17.

 **Note**

From main menu->Setting->Network->P2P, you can go to P2P interface.



Figure 4-17

Step 2 Check the box to enable P2P function.

Step 3 Click Next button to complete setup.

The status is online if the P2P registration is successful.

Client Operation

Please follow the steps listed below.

Step 1 Use the cell phone to scan the QR code on the interface and then download and install the cell phone app.



Step 2 Open App; tap  to go to the Live preview.

Step 3 Tap  at the top left corner, you can see the main menu.

Step 4 Tap Device manager button, you can use several modes (P2P/DDNS/IP and etc.) to add the

device. Click  to save current setup. Tap Start Live preview to view all-channel video from the connected device. See Figure 4-18.

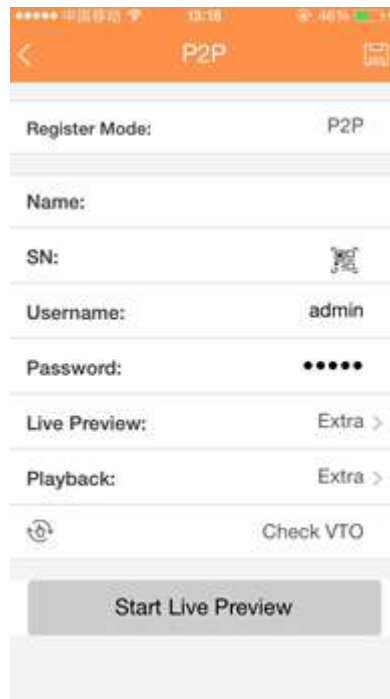

Figure 4-18

Step 5 Click Start live preview to view real-time video.

4.1.4.4 Smart Add

Note

The following figure appears if you check the box to enable smart add function on the startup wizard.

When the network camera(s) and the device are in the same router or switch, you can use smart add function to add network cameras to the device.

Please follow the steps listed below.

Step 1 Click Next,

Enter the following interface. See Figure 4-19.

Note

- On the preview interface, right click mouse and then select Smart add.
- On the Smart add mode, the connected camera uses NVR password and email information by default.

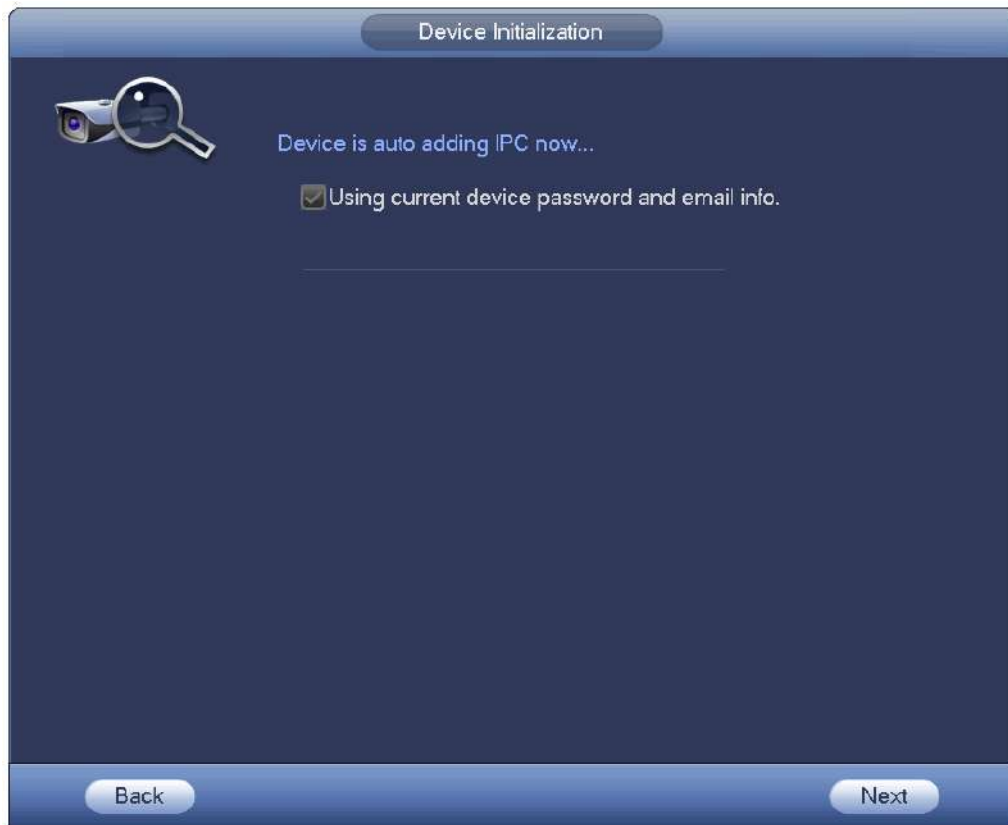

Figure 4-19

Step 2 Click Next button to continue.

- 1) Device now enables DHCP function. It says DHCP is in process now, please wait. See Figure 4-20.



Figure 4-20

- 2) Device goes to change IP address interface. Please change IP address if necessary and then click OK button. See Figure 4-21. Please note this step is optional.

 **Note**

Please make sure there are several IP segments in the LAN. Otherwise, you can skip this step.

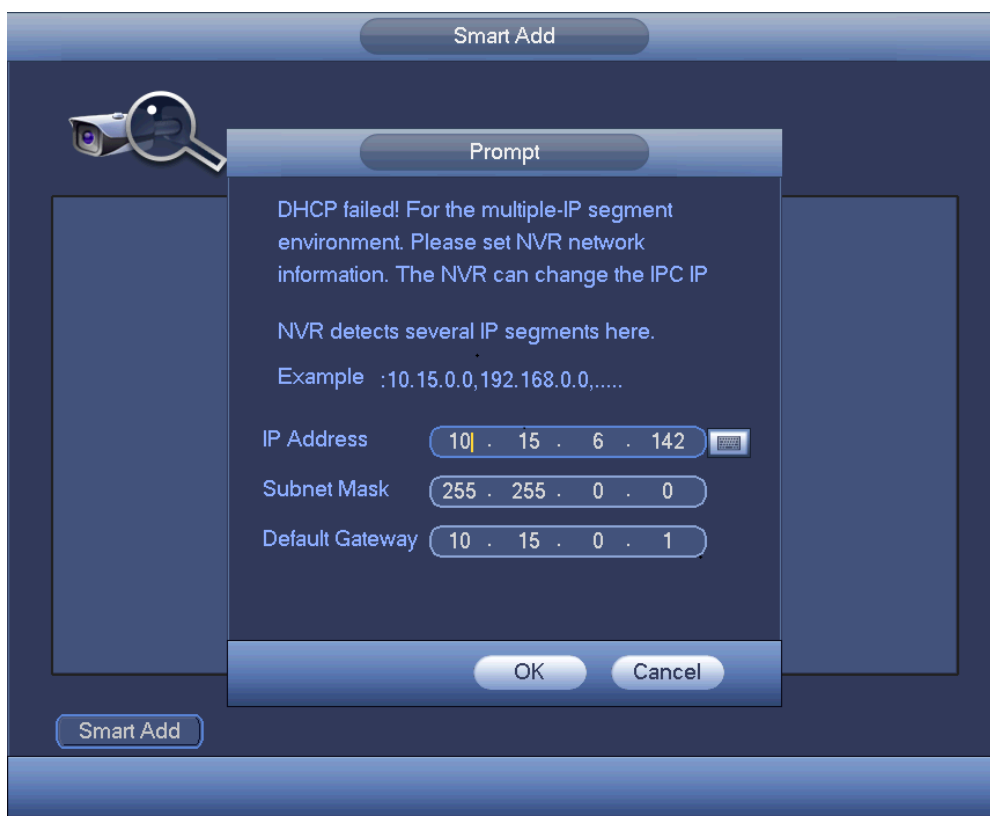

Figure 4-21

- 3) After complete DHCP function, device is automatically adding network camera to the corresponding channels. See Figure 4-22.



Figure 4-22

- 4) Device pops up following dialog box after it successfully added network cameras. See Figure 4-23.



Figure 4-23

Step 3 Click YES button to complete smart add operation.

4.1.4.5 Registration

Note

If you skip the smart add function on the startup wizard process, please go to this interface to add the remote device.

After add remote device, the device can receive, storage, and manage the video streams of the remote device. You can view, browse, playback, manage several remote devices at the same time.

Step 1 On the P2P interface, click Next button.

Enter remote device interface. See Figure 4-24.

Note

There are two ways to go to Registration interface.

- From main menu->Setting->Camera->Registration, you can go to the registration interface.
- On the preview interface, right click mouse and then select Registration.



Figure 4-24

Step 2 Set parameters

- Channel: It is the device channel number. If you have not added the network camera, the channel number is shown as .
- Status: Red circle means current channel has no video, green circle means current channel has video.
- IP address: It is to display network camera IP address.
- Type: There are two connection types. You can use the network to connect to the camera or use the WIFI. The means current network camera connection mode is general; the means current network camera mode is hotspot.
- Add/Delete: Click to delete the device, click to add the device to the NVR.

Step 3 Add network camera.

- Device search: Click the button; you can search all network cameras in the same network segment. See Figure 4-25. Double click a camera or check the camera box and then click Add button, you can add a device to the list.

Note

The device in the added device list is not shown in the search result column.



Figure 4-25

- Manual Add: Click Manual Add button, you can set the corresponding network camera information and then select the channel you want to add. See Figure 4-26.
 - ◇ Manufacturer: Please select from the dropdown list.



Note

Different series products may support different manufactures, please refer to the actual product.

- ◇ IP address: Input remote device IP address.
- ◇ RTSP port: Input RTSP port of the remote device. The default setup is 554.



Note

Skip this item if the manufacture is private or customize.

- ◇ HTTP port: Input HTTP port of the remote device. The default setup is 80.



Note

Skip this item if the manufacture is private or customize.

- ◇ TCP port: Input TCP port of the remote device. The default setup is 37777.
- ◇ User name/password: The user name and password to login the remote device.

- ✧ Channel No.: Input channel amount or click the Connect button to get the channel amount of the remote device.

 **Note**

We recommend click Connect button to get remote device channel amount, the manual add operation may result in failure if the input channel amount is not right.

- ✧ Remote channel No.: After getting the remote device channel amount, click Setup to select a channel.

 **Note**

Click to select one or more remote channel numbers here.

- ✧ Channel: The local channel number you want to add. One channel name has corresponding one channel number.
- ✧ Decode buffer: There are three items: realtime,local,fluent.
- ✧ Service type: There are four items: auto/TCP/UDP/MULTICAST(ONVIF device only)

 **Note**

- ✧ The default connection mode is TCP if the connection protocol is private.
- ✧ There are three items:TCP/UDP/MULTICAST if the connection protocol is ONVIF.
- ✧ There are two items: TCP/UDP if the connection protocol is from the third-party.



Figure 4-26

Step 4 Click OK to add the camera to the device.

 **Note**

Click  to change the remote device information. Click  to delete remote device. .

4.1.4.6 Schedule

After set record schedule and snapshot schedule, the device can automatically record video and snapshot image at the specified time.

4.1.4.6.1 Schedule Record

After set schedule record, device can record video file according to the period you set here. For example, the alarm record period is from 6:00~18:00 Monday, device can record alarm video files during the 6:00~18:00.

All channels are record continuously by default. You can set customized record period and record type.

Step 1 Click Next button.

Enter schedule interface. See Figure 4-27.

Note

From main menu->Setting->Storage->Schedule->Record, you can go to the record interface.



Figure 4-27

Step 2 Set parameters.

- Channel: Please select the channel number first. You can select “all” if you want to set for the whole channels.

✧ : Sync connection icon. Select icon  of several dates, all checked items can be edited or together. Now the icon is shown as .

✧ : Click it to delete a record type from one period.

- Record Type: Please check the box to select corresponding record type. There are six types: Regular/MD (motion detect)/Alarm/MD&Alarm/IVS/POS.
- Week day: There are eight options: ranges from Saturday to Sunday and all.
- Holiday: It is to set holiday setup. Please note you need to go to the General interface (Main Menu->Setting->System->General) to add holiday first. Otherwise you cannot see this item.
- Pre-record: System can pre-record the video before the event occurs into the file. The value ranges from 1 to 30 seconds depending on the bit stream.
- Redundancy: System supports redundancy backup function. It allows you backup recorded file in two disks. You can highlight Redundancy button to activate this function. Please note, before enable this function, please set at least one HDD as redundant. (Main menu->Setting->Storage->HDD Manager). Please note this function is null if there is only one HDD.
- ANR: It is to save video to the SD card of the network camera in case the network connection fails. The value ranges from 0s~43200s. After the network connection resumed, the system can get the video from the SD card and there is no risk of record loss.
- Period setup: Click button  after one date or a holiday, you can see an interface shown as in Figure 4-28. There are five record types: regular, motion detection (MD), Alarm, MD & alarm and IVS.



Figure 4-28

Please following the steps listed below to draw the period manually.

Step 1 Select a channel you want to set. See Figure 4-29.



Figure 4-29

Step 2 Set record type. See Figure 4-30.



Figure 4-30

Note

- When the record type is MD (motion detect), alarm, MD&Alarm, IVS and POS, please enable the channel record function when corresponding alarm occurs. For example, when the alarm type is MD, from main menu->Setting->Event->Video Detect->Motion Detect, please select the record channel and enable record function. See Figure 4-31.
- When the record type is MD (motion detect), alarm, MD&Alarm, IVS and POS, refer to chapter 4.7.1 Video detect, chapter 4.7.9 Alarm Settings, chapter 4.7.3 IVS and chapter 4.7.12 POS.

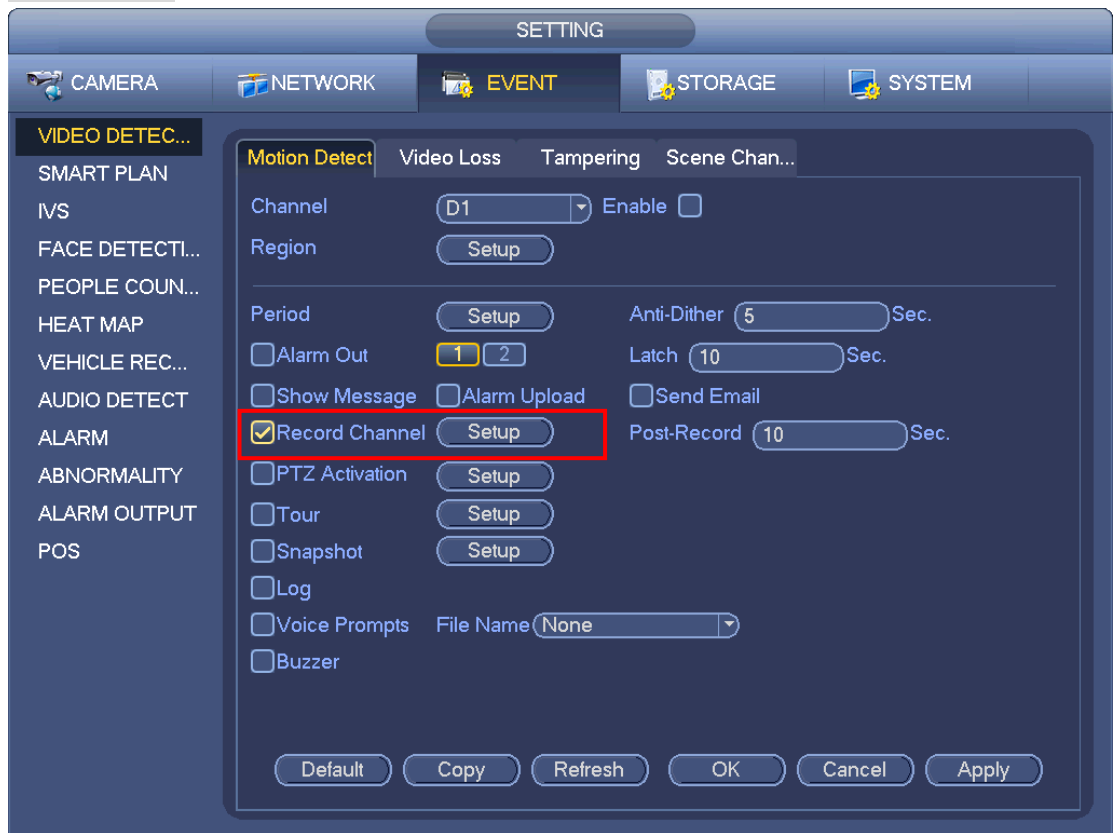

Figure 4-31

Step 3 Please draw manually to set record period. There are six periods in one day. See Figure 4-32.

Note

If you have added a holiday, you can set the record period for the holiday.

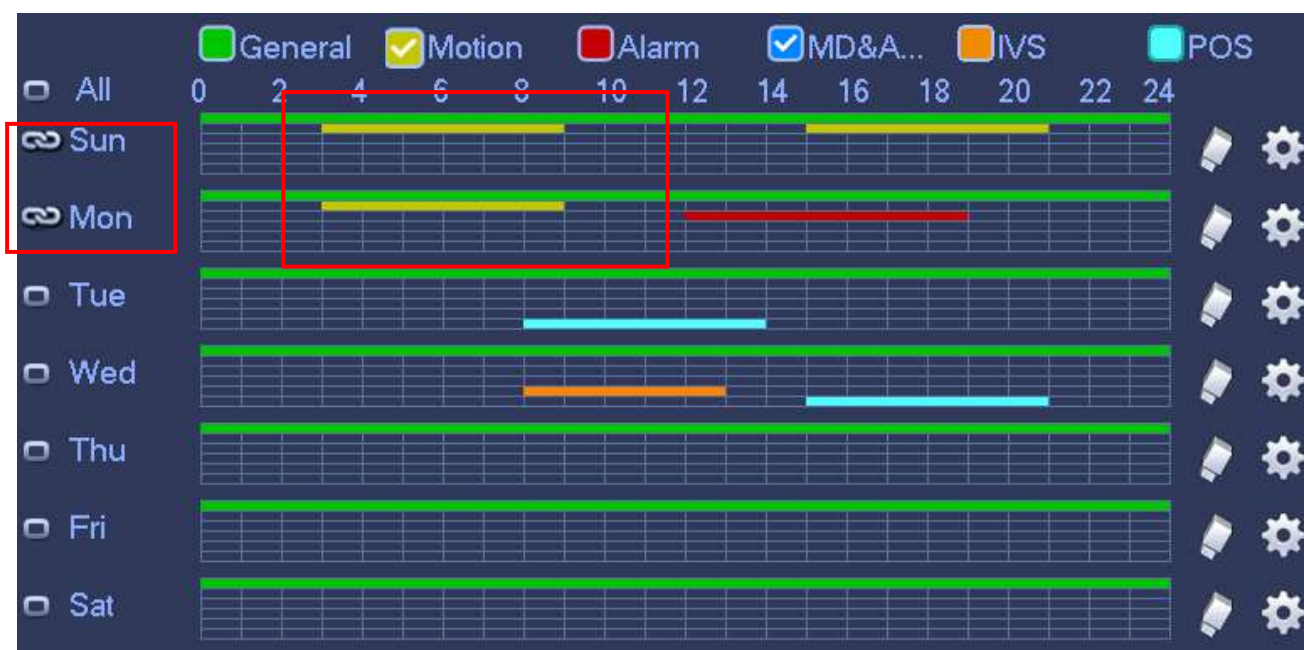

Figure 4-32

Step 4 Click Apply button to save schedule record settings.

 **Note**

Please enable auto record function so that the record plan can become activated. Refer to chapter 4.1.4.6.3 Record control for detailed information.

4.1.4.6.2 Schedule Snapshot

It is to set schedule snapshot period.

After set schedule snapshot, device can snapshot image according to the period you set here. For example, the alarm snapshot period is from 6:00~18:00 Monday, device can snapshot during the 6:00~18:00 when an alarm occurs.

Step 1 Click Snapshot button, device goes to following interface. See Figure 4-33.

 **Note**

From main menu->Setting->Storage->Schedule->Snapshot, you can go to the snapshot interface.



Figure 4-33

Step 2 Select a channel to set schedule snapshot.

Step 3 Set snapshot type as schedule. Refer to chapter 4.2.5.3 Snapshot for detailed information.

Step 4 Check the box to set alarm type. See Figure 4-34.



Figure 4-34

Note

- When the record type is MD (motion detect), alarm, MD&Alarm, IVS and POS, please enable the channel snapshot function when corresponding alarm occurs. For example, when the alarm type is MD, from main menu->Setting->Event->Video Detect->Motion Detect, please select the snapshot channel and enable snapshot function. See Figure 4-35.
- When the snapshot type is MD (motion detect), alarm, MD&Alarm, IVS, refer to chapter 4.7.1 Video detect, chapter 4.7.9 Alarm Settings, chapter 4.7.3 IVS and chapter 4.7.12 POS.

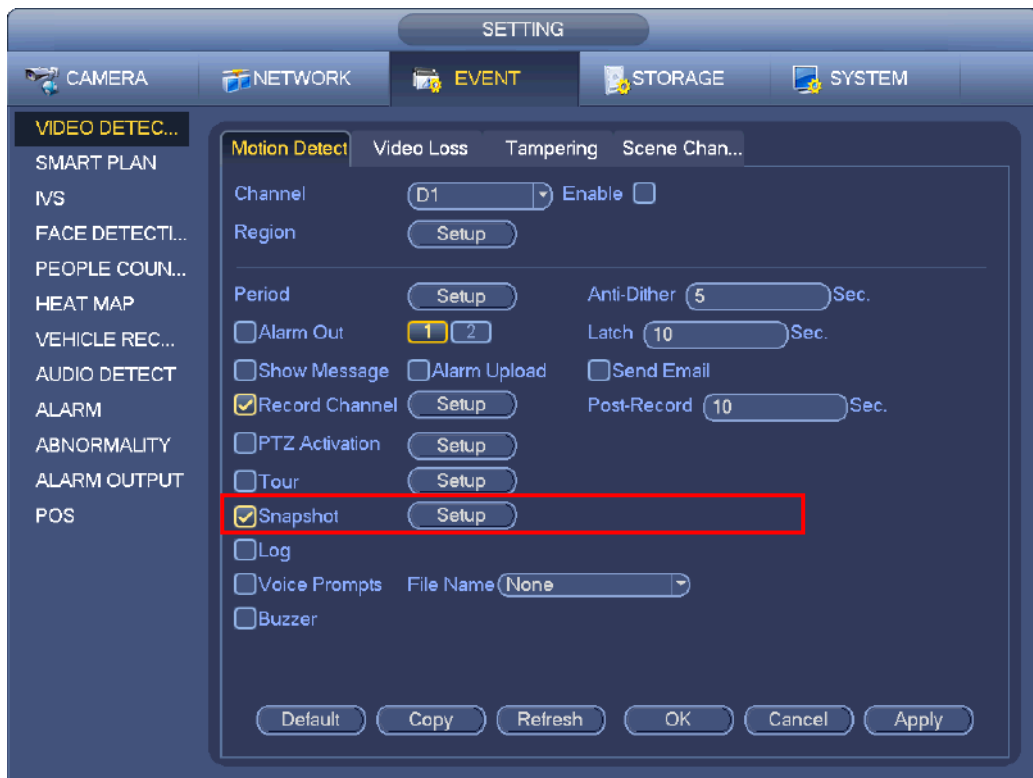

Figure 4-35

- Step 5 Refer to chapter 4.1.4.6.1 to set snapshot period.
- Step 6 Click Apply button to save snapshot plan.

Note

Please enable auto snapshot function so that the snapshot plan can become activated. Refer to chapter 4.1.4.6.3 Record control for detailed information.

- Step 7 Click Finish button, system pops up a dialogue box. Click the OK button, the startup wizard is complete. See Figure 4-36.



Figure 4-36

4.1.4.6.3 Record Control

Note

You need to have proper rights to implement the following operations. Please make sure the HDD has been properly installed.

There are three ways for you to go to record menu.

- Right click mouse and then select Manual->Record.
- In the main menu, from Setting->Storage->Record.
- In live viewing mode, click record button in the front panel or record button in the remote control.

After set schedule record and schedule snapshot function, please enable auto record and auto snapshot function so that the device can automatically record and snapshot. System supports main stream and sub stream. There are three statuses: schedule/manual/stop. See Figure 4-37. Please highlight icon “○” to select corresponding channel.

- Manual: The highest priority. After manual setup, all selected channels will begin general recording.
- Schedule: Channel records as you have set in recording setup (Main Menu->Setting->Storage->>Schedule)
- Stop: Current channel stops recording.
- All: Check All button after the corresponding status to enable/disable all-channel schedule/manual record or enable/disable all channels to stop record.
- Snapshot: Select one or more channel(s) first and then enable/disable schedule snapshot function.



Figure 4-37

4.1.4.6.4 Record Info

After system recorded video files, go to the record info interface to view device name, start time, end time and etc.

From main menu->Info-System->Record, the interface is shown as below. See Figure 4-38.



Figure 4-38

4.2 Camera

4.2.1 Connection

After register a remote device to the NVR, you can view the video on the NVR, and manage and storage the video file. Different series products support different remote device amount. Refer to chapter 4.1.4.4 Registration to add a camera.

4.2.1.1 Change IP address

Step 1 From Main menu->Setting->Camera->Registration, check the box before the camera name and then click Change IP or click the  before the camera name.

Enter change IP interface. See Figure 4-39.

Note

Check the box before several cameras, change the IP addresses of several cameras at the same time.

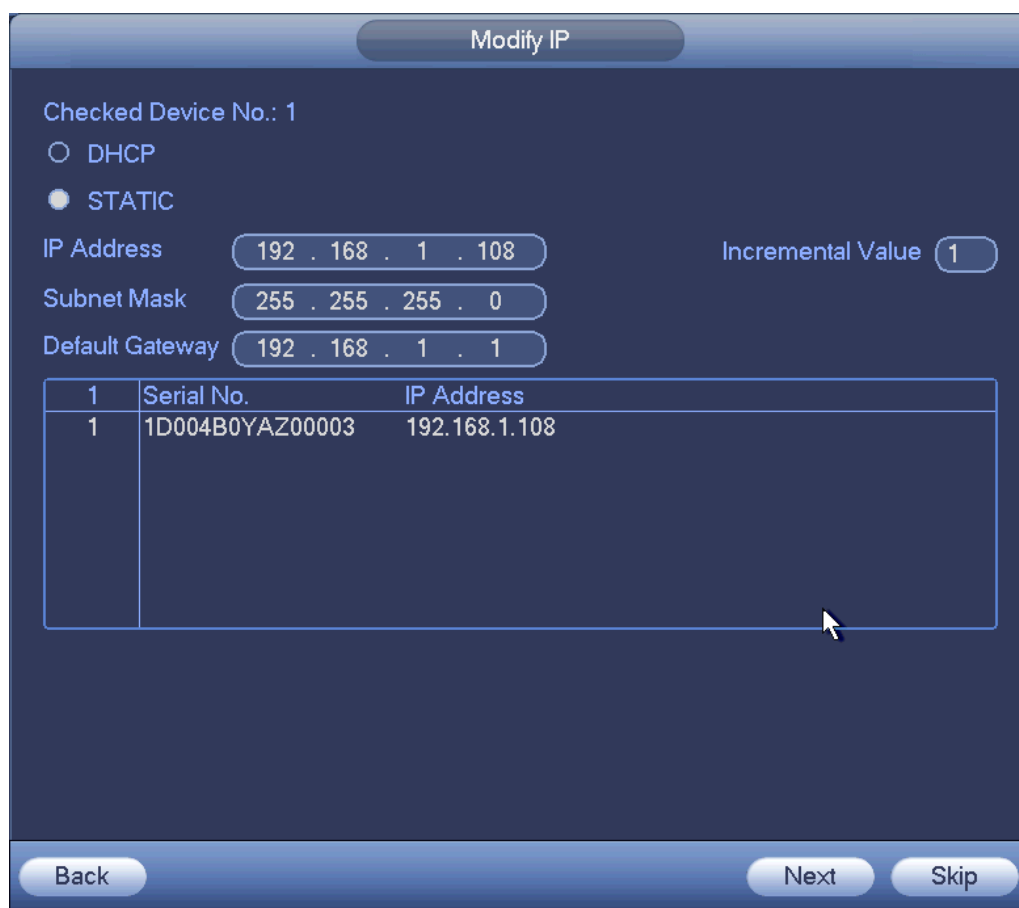

Figure 4-39

Step 2 Select IP mode.

Check DHCP, there is no need to input IP address, subnet mask, and default gateway. Device automatically allocates the IP address to the camera.

Check Static, and then input IP address, subnet mask, default gateway and incremental value.

 **Note**

If it is to change several devices IP addresses at the same time, please input incremental value. Device can add the fourth address of the IP address one by one to automatically allocate the IP addresses.

If there is IP conflict when changing static IP address, device pops up IP conflict dialogue box. If batch change IP address, device automatically skips the conflicted IP and begin the allocation according to the incremental value

Step 3 Input remote device user name and password.

Step 4 Click OK button to save settings.

After the changing operation, search again, device displays new IP address.

 **Note**

When change IP addresses of several devices at the same time, make sure the cameras user name and passwords are the same.

4.2.1.2 IP Export

Device can export the Added device list to your local USB device.

- Step 1 Insert the USB device and then click the Export button.
Enter the following interface. See Figure 4-40.

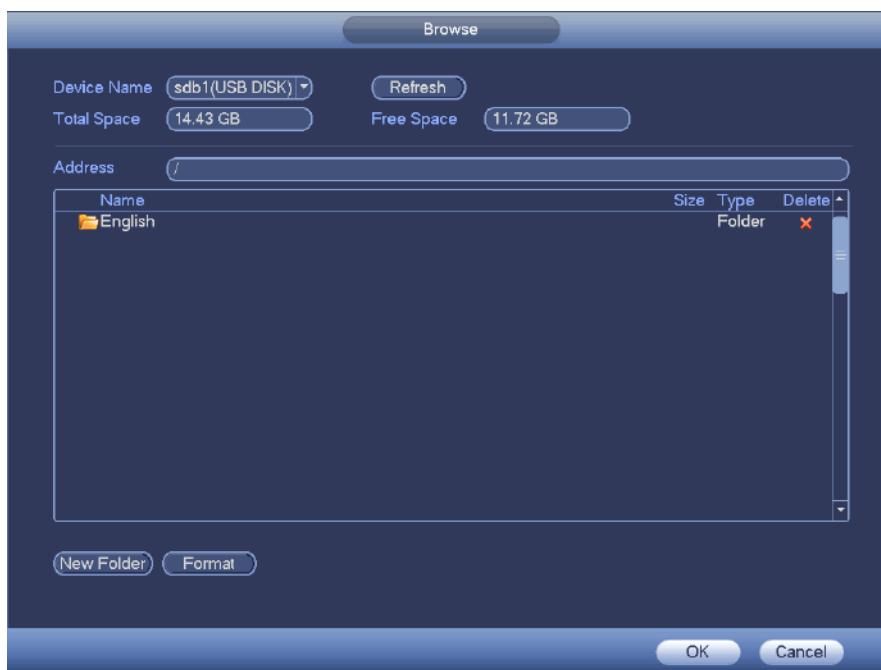

Figure 4-40

- Step 2 Select the directory address and then click the OK button.
Step 3 Device pops up a dialogue box to remind you successfully exported. Please lick OK button to exit.

 **Note**

The exported file extension name is .CVS. The file information includes IP address, port, remote channel number, manufacturer, user name and password.

4.2.1.3 IP Import

- Step 1 Click Import button.
Enter the following interface. See Figure 4-41.



Figure 4-41

- Step 2 Select the import file and then click the OK button. System pops up a dialogue box to remind you successfully imported.
- Step 3 Click OK button to exit.

 **Note**

If the imported IP has conflicted with current added device, system pops up a dialogue box to remind you. You have two options:

- Step 4 Click OK button, system uses the imported setup to overlay current one.



Important

- You can edit the exported .CVS file. **Do not change the file format; otherwise it may result in import failure.**
- Does not support customized protocol import and export.
- The import and export device shall have the same language format.

4.2.2 Remote Device Initialization

Remote device initialization can change remote device login password and IP address.

 **Note**

- When connect a camera to the NVR via PoE port, NVR automatically initialize the camera. The camera adopts NVR current password and email information by default.
- When connect a camera to the NVR via PoE port after NVR upgraded to the new version, the NVR may fail to initialize the camera. Please go to the Registration interface to initialize the camera.

- Step 1 From main menu->Setting->Camera->Registration.
Enter Registration interface.

- Step 2 Click Device Search and then click Uninitialized.
Device displays camera(s) to be initialized.
- Step 3 Select a camera to be initialized and then click Initialize.
Device displays password setup interface. See Figure 4-42.

 **Note**

- If you want to use current device password and email information, the remote device automatically uses NVR admin account information (login password and email). There is no need to set password and email. Please go to step 4.

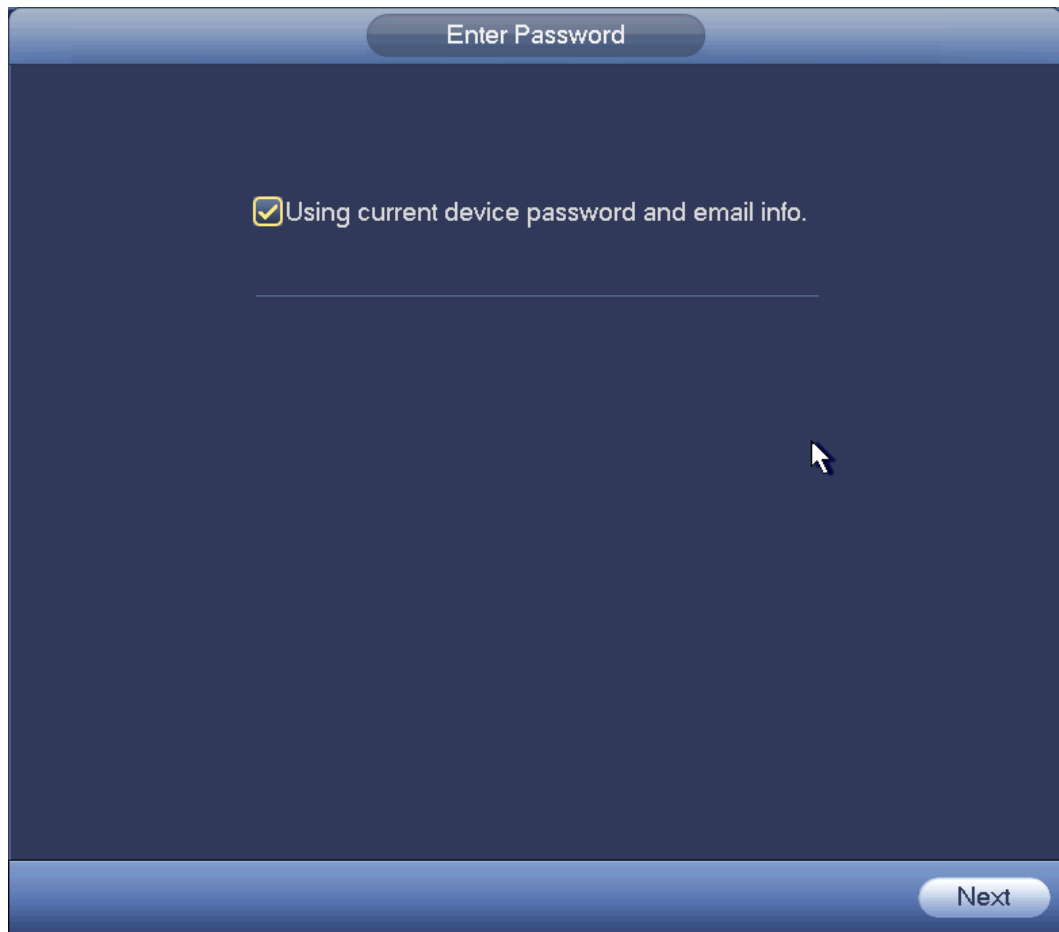

Figure 4-42

1. Cancel using current device password and email information, Enter password setting interface. See Figure 4-43.

Enter Password

Using current device password and email info.

Username admin

Password

It is 8 to 32-digit containing letter(s), number(s), symbol(s). It contains at least two types.

Confirm Password

Next

Figure 4-43

2. Set camera password.

- The user name is **admin**. The password ranges from 8 to 32 digitals. It can contain letters, numbers and special characters (excluding “”, “'”, “;”, “:”, “&”). The password shall contain at least two categories. Usually we recommend the strong password.



WARNING

STRONG PASSWORD RECOMMENDED-For your device own safety, please create a strong password of your own choosing. We also recommend you change your password periodically especially in the high security system.

3. Click Next button.

Enter input email interface. See Figure 4-44.

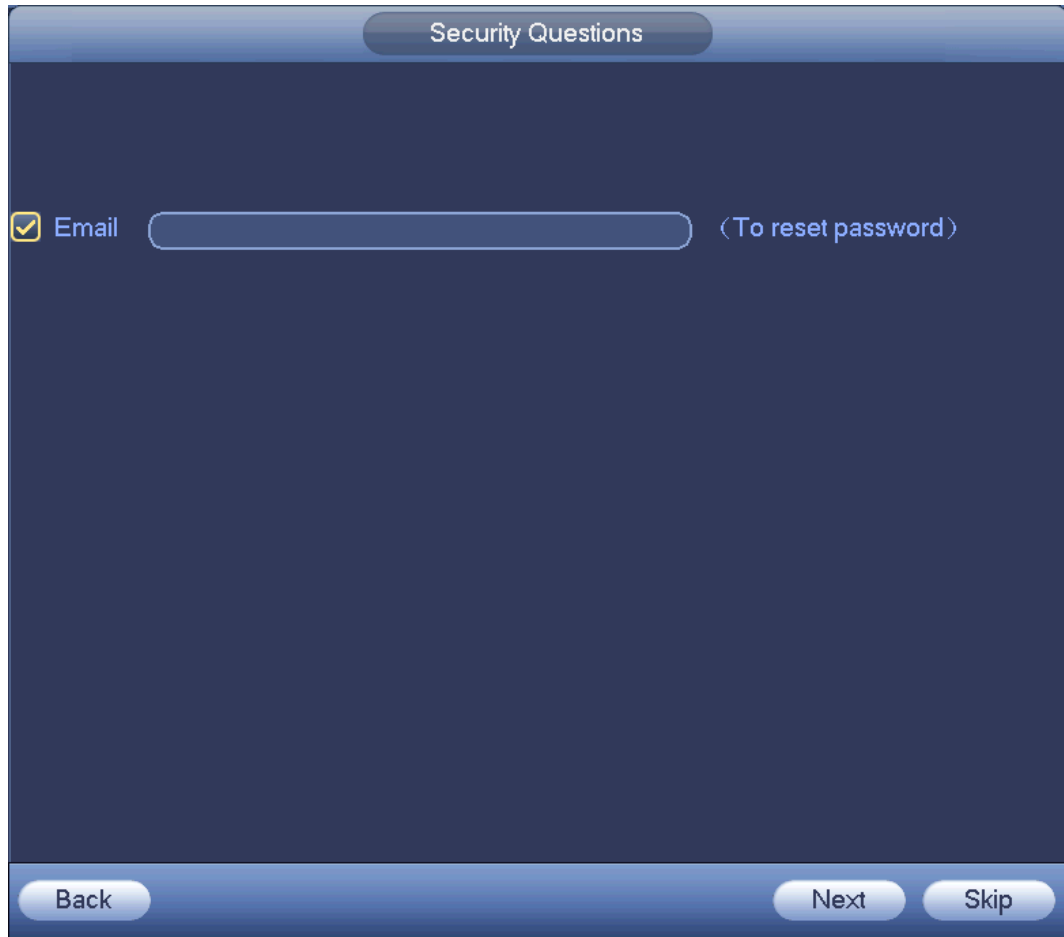

Figure 4-44

4. Set email information.

Email: Input an email address for reset password purpose.

 **Note**

Cancel the box and then click Next or Skip if you do not want to input email information here.

Step 4 Click Next button.

Enter Change IP address interface. See Figure 4-45.

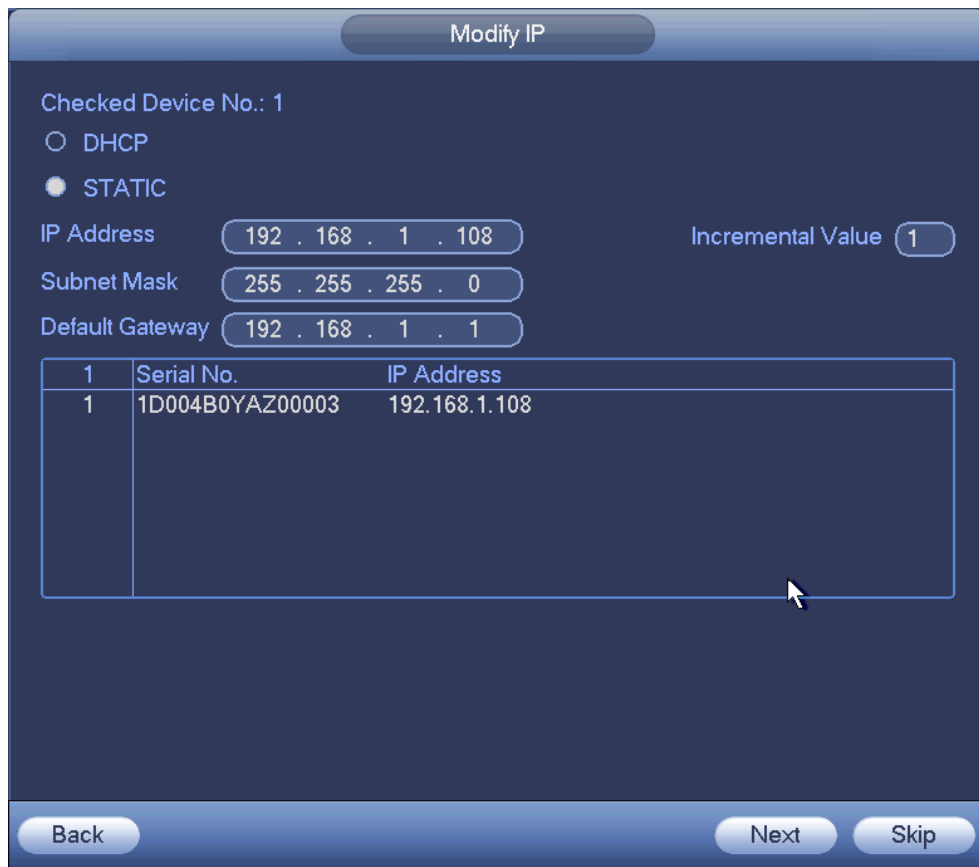

Figure 4-45

Step 5 Set camera IP address

Check DHCP, there is no need to input IP address, subnet mask, and default gateway. Device automatically allocates the IP address to the camera.

Check Static, and then input IP address, subnet mask, default gateway and incremental value.

 **Note**

- If it is to change several devices IP addresses at the same time, please input incremental value. Device can add the fourth address of the IP address one by one to automatically allocate the IP addresses.
- If there is IP conflict when changing static IP address, device pops up IP conflict dialogue box. If batch change IP address, device automatically skips the conflicted IP and begin the allocation according to the incremental value

Step 6 Click Next button.

Device begins initializing camera. See Figure 4-46.

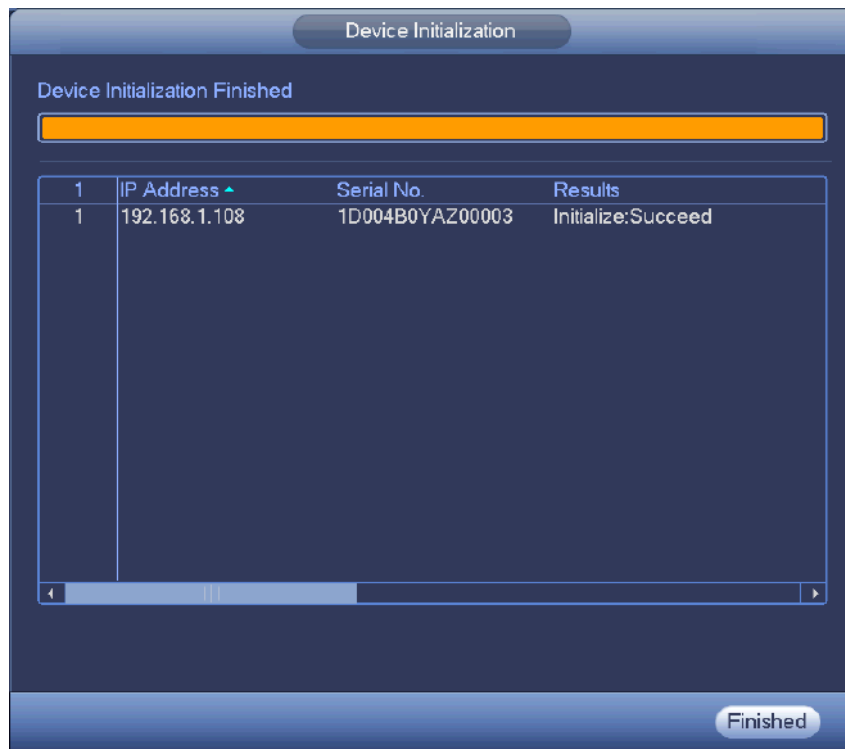

Figure 4-46

Step 7 Click Finish to complete the setup.

4.2.3 Short-Cut Menu to Register Camera

If you have not register a remote device to a channel, please go to the preview interface to add.

Step 1 On the preview interface,

Move your mouse to the center, there is an icon "+". See Figure 4-47.

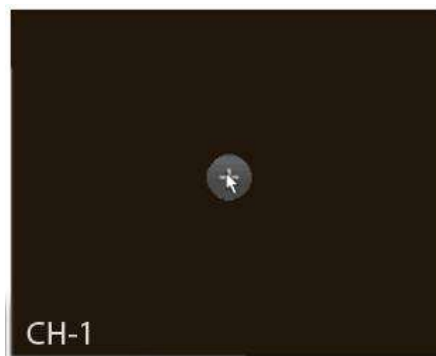

Figure 4-47

Step 2 Click "+", device pops up interface to add network camera. Refer to chapter 4.1.4.5 Registration for detailed information.

4.2.4 Image

It is to set network camera parameters according to different environments. It is to get the best video effect.

From main menu->setting->camera->image, you can see the image interface is shown as below. See Figure 4-48.

- Channel: Select a channel from the dropdown list.
- Saturation: It is to adjust monitor window saturation. The value ranges from 0 to 100. The default value is 50. The larger the number, the stronger the color is. This value has no effect on the general brightness of the whole video. The video color may become too strong if the value is too high. For the grey part of the video, the distortion may occur if the white balance is not accurate. Please note the video may not be attractive if the value is too low. The recommended value ranges from 40 to 60.
- Brightness: It is to adjust monitor window bright. The value ranges from 0 to 100. The default value is 50. The larger the number is, the brighter the video is. When you input the value here, the bright section and the dark section of the video will be adjusted accordingly. You can use this function when the whole video is too dark or too bright. Please note the video may become hazy if the value is too high. The recommended value ranges from 40 to 60.
- Contrast: It is to adjust monitor window contrast. The value ranges from 0 to 100. The default value is 50. The larger the number is, the higher the contrast is. You can use this function when the whole video bright is OK but the contrast is not proper. Please note the video may become hazy if the value is too low. If this value is too high, the dark section may lack brightness while the bright section may over exposure. The recommended value ranges from 40 to 60.
- Auto Iris: It is for the device of the auto lens. You can check the box before ON to enable this function. The auto iris may change if the light becomes different. When you disable this function, the iris is at the max. System does not add the auto iris function in the exposure control. This function is on by default.
- Mirror: It is to switch video up and bottom limit. This function is disabled by default.
- Flip: It is to switch video left and right limit. This function is disabled by default.
- BLC: It includes several options: BLC/WDR/HLC/OFF.
- ✧ BLC: The device auto exposures according to the environments situation so that the darkest area of the video is cleared
- ✧ WDR: For the WDR scene, this function can lower the high bright section and enhance the brightness of the low bright section. So that you can view these two sections clearly at the same time. The value ranges from 1 to 100. When you switch the camera from no-WDR mode to the WDR mode, system may lose several seconds record video.
- ✧ HLC: After you enabled HLC function, the device can lower the brightness of the brightest section according to the HLC control level. It can reduce the area of the halo and lower the brightness of the whole video.
- ✧ OFF: It is to disable the BLC function. Please note this function is disabled by default.
- Profile: It is to set the white balance mode. It has effect on the general hue of the video. This function is on by default. You can select the different scene mode such as auto, sunny, cloudy, home, office, night, disable and etc to adjust the video to the best quality.
- ✧ Auto: The auto white balance is on. System can auto compensate the color temperature to make sure the video color is proper.
- ✧ Sunny: The threshold of the white balance is in the sunny mode.
- ✧ Night: The threshold of the white balance is in the night mode.
- ✧ Customized: You can set the gain of the red/blue channel. The value ranges from 0 to 100.
- Day/night. It is to set device color and the B/W mode switch. The default setup is auto.
- ✧ Color: Device outputs the color video.
- ✧ Auto: Device auto select to output the color or the B/W video according to the device feature (The general bright of the video or there is IR light or not.)
- ✧ B/W: The device outputs the black and white video.

- ✧ Sensor: It is to set when there is peripheral connected IR light.
Please note some non-IR series product support sensor input function.



Figure 4-48

4.2.5 Encode

It is to set video encode parameters such as video bit rates, video overlay, snapshot settings.

4.2.5.1 Encode

It is to set IPC encode mode, resolution, bit stream type and etc.

Note

Some series products support three streams: main stream, sub stream 1, sub stream 2. The sub stream maximally supports 1080P.

From Main menu->Setting->System->Encode, you can see the following interface. See Figure 4-49.

- Channel: Select the channel you want.
- Type: It is to set device bit stream type.
- ✧ For main stream, there are three options: regular/motion detect/alarm. The sub stream supports regular bit streams only.
- ✧ The active control frame function (ACF) can record in different frame rates. For example, you can use high frame rate to record important events, record scheduled event in lower frame rate.
- ✧ Set different frame rates for different record events.

Note

Some series products do not support motion detect bit streams and alarm streams.

- Compression: Video encode mode.
- ✧ H.264: Main Profile encode mode.

- ◇ H.264H: High Profile encode mode.
- ◇ H.264B: Baseline Profile encode mode.
- ◇ H.265: Main Profile encode mode.
- ◇ MJPEG: System needs high bit streams to guarantee video definition. Use the recommended max bit stream value to get the better video effect.
- Smart Codec: This function is to reduce bit streams.

 **Note**

- ◇ Some series products support smart codec function.
- ◇ After changing smart code, please reboot network camera and some network camera functions (such as IVS, ROI, SVC, lobby mode and etc.) becomes null. Please think twice before the operation.
- Resolution: The resolution here refers to the capability of the network camera.

 **Note**

Different series products support different resolutions. Please refer to the actual interface for detailed information.

- Frame rate (FPS): The video frame amount displayed in each second. The higher the frame rate is, the clearer and more fluent the video is. The frame rate may vary depending on the resolution.
- Bit rate type: System supports two types: CBR and VBR.
 - ◇ Main stream: It is to set frame rate to change video quality. The higher the frame rate is, the better the video quality is. The referenced bit rate is the recommended value.
 - ◇ Sub stream: In CBR mode, the bit stream is near the specified value. In VBR mode, the video quality changes according to the bit stream value. But its max value is near the specified value.
- Reference bit rate: The reference bit rate depends on the resolution and frame rate you set.
- Video/audio: You can enable or disable the video/audio. The main stream is enabled by default. After enable the audio function, the record file is composite file consisting of the video and audio. For the sub stream 1, please enable video first and then enable audio function.
- Audio format: Set audio encode format.

 **Note**

Different series products support different audio encode mode. Please refer to the actual interface for detailed information.

- Sampling rate: Audio sampling rate refers to the sampling amount within 1 second. The higher the value is, the better the audio is. The default setup is 8K.
- Copy: After you complete the setup, you can click Copy button to copy current setup to other channel(s). You can see an interface is shown as in Figure 4-52. You can see current channel number is grey. Please check the number to select the channel or you can check the box ALL. Please click the OK button in Figure 4-52 and Figure 4-50 respectively to complete the setup. Please note, once you check the All box, you set same encode setup for all channels. Audio/video enable box, overlay button and the copy button is shield.

Please highlight icon  to select the corresponding function.



Figure 4-49

4.2.5.2 Overlay

Click overlay button, you can see an interface is shown in Figure 4-50.

- Cover area: Here is for you to cover area section. You can drag you mouse to set proper section size. In one channel video, system max supports 4 zones in one channel. You can set with Fn button or direction buttons.
- Preview/monitor: The cover area has two types. Preview and Monitor. Preview means the privacy mask zone cannot be viewed by user when system is in preview status. Monitor means the privacy mask zone cannot be view by the user when system is in monitor status.
- Time display: You can select system displays time or not when you playback. Please click set button and then drag the title to the corresponding position in the screen.
- Channel display: You can select system displays channel number or not when you playback. Please click set button and then drag the title to the corresponding position in the screen.



Figure 4-50

4.2.5.3 Snapshot

Here you can set snapshot mode, picture size, quality and frequency. See Figure 4-51.

- Snapshot mode: There are two modes: regular and trigger. If you set regular mode, you need to set snapshot frequency. If you set trigger snapshot, you need to set snapshot activation operation.
- Image size: Here you can set snapshot picture size.
- Image quality: Here you can set snapshot quality. The value ranges from 1 to 6.
- Interval: It is for you to set timing (schedule) snapshot interval.



Figure 4-51

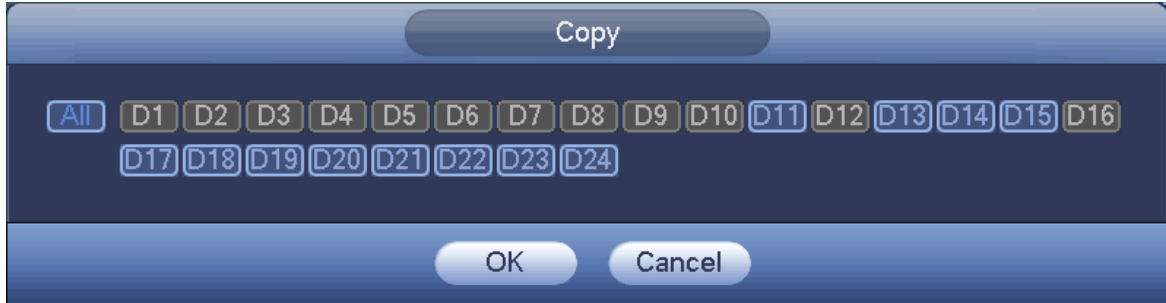

Figure 4-52

4.2.6 Channel Name

From main menu->Setting->Camera-Channel name, you can see an interface shown as in Figure 4-53. It is to modify channel name. It max supports 63-character.

Please note you can only modify the channel name of the connected network camera.



Figure 4-53

4.2.7 Remote Upgrade

It is to upgrade the connected network camera firmware. It includes online upgrade and file upgrade. From main menu->setting->camera->remote, the interface is shown as below. See Figure 4-54.

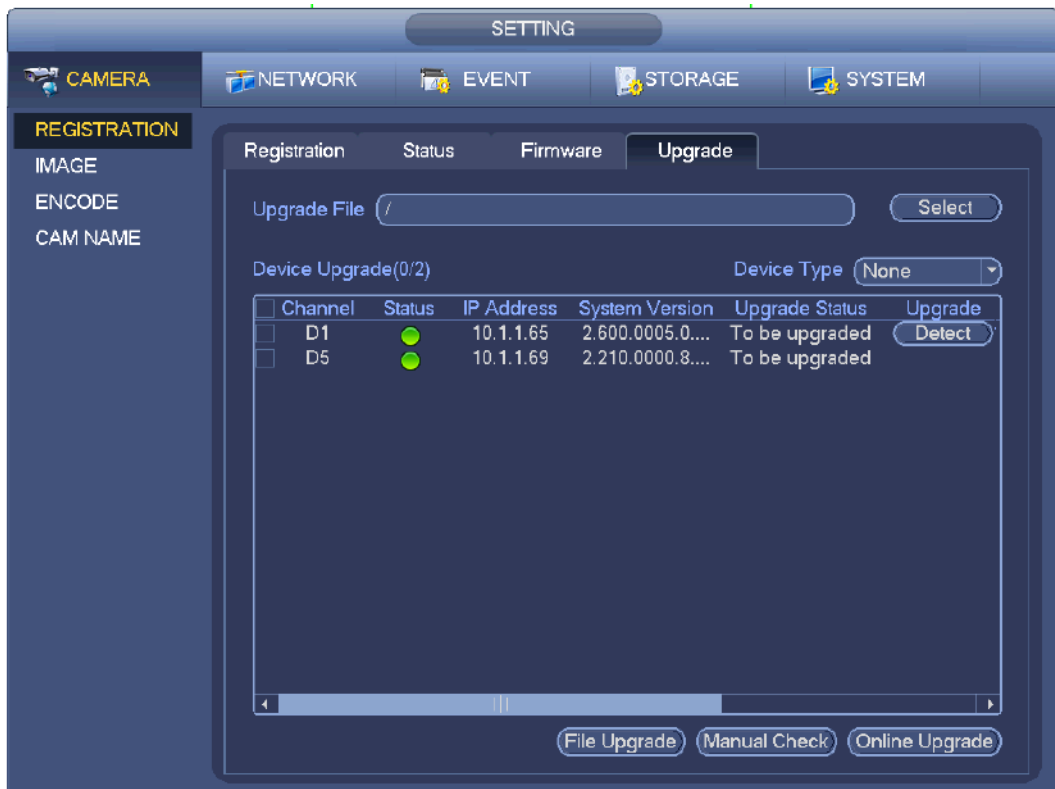

Figure 4-54

Online Upgrade

- Step 1 Select a remote device and then click the Detect button on the right side, or check a box to select a remote device and then click Manual Check.
System detects the new version on the cloud.
- Step 2 Select a remote device that has new version and then click online upgrade.
After successful operation, system pops up upgrade successful dialogue box.

File upgrade

- Step 1 Select a channel and then click File upgrade.
- Step 2 Select upgrade file on the pop-up interface.
- Step 3 Select the upgrade file and then click OK button.
After successful operation, system pops up upgrade successful dialogue box.

Note

If there are too much remote devices, select device type from the drop-down list to search the remote device you desire.

4.2.8 Remote Device Info

4.2.8.1 Device Status

Here you can view the IPC status of the corresponding channel such as motion detect, video loss, tampering, alarm and etc. See Figure 4-55.





- IPC status: : Front-end does not support. : Front-end supports. : There is alarm event from current front-end.
- Connection status: : Connection succeeded. : Connection failed.
- Refresh: Click it to get latest front-end channel status.



Figure 4-55

4.2.8.2 Firmware

It is to view channel, IP address, manufacturer, type, system version, SN, video input, audio input, external alarm and etc. See Figure 4-56.



Figure 4-56

4.3 Preview

After device booted up, the system is in multiple-channel display mode. See Figure 4-57. Please note the displayed window amount may vary. The following figure is for reference only. Please refer to chapter 1.3 Specifications for the window-amount your product supported.







Figure 4-57

4.3.1 Preview

If you want to change system date and time, you can refer to general settings (Main Menu->Setting->System->General). If you want to modify the channel name, please refer to the display settings (Main Menu->Camera->CAM name)

Please refer to the following sheet for detailed information.

SN	Icon	Function
1		When current channel is recording, system displays this icon.
2		When motion detection alarm occurs, system displays this icon.
3		When video loss alarm occurs, system displays this icon.
4		When current channel is in monitor lock status, system displays this icon.

Tips

- Preview drag: If you want to change position of channel 1 and channel 2 when you are previewing, you can left click mouse in the channel 1 and then drag to channel 2, release mouse you can switch channel 1 and channel 2 positions.
- Use mouse middle button to control window split: You can use mouse middle button to switch window split amount.

4.3.2 Navigation bar

On the preview interface, left click mouse, you can view the navigation bar. See Figure 4-58 or Figure 4-59.



Note

- Different series products may display different navigation bar icons. Refer to the actual product for detailed information.
- Go to the Main menu->Setting->System->General to enable navigation bar function; otherwise you cannot see the following interface.



Figure 4-58



Figure 4-59

4.3.2.1 Main Menu



Click button to go to the main menu interface.

4.3.2.2 Dual-screen operation

Important

This function is for some series only.



Click to select screen 2, you can view an interface shown as below. See Figure 4-60. It is a navigation bar for screen 2.



Figure 4-60

Click any screen split mode; HDMI2 screen can display corresponding screens. Now you can control two screens. See Figure 4-61.



Figure 4-61





Note

- Screen 2 function is null if tour is in process. Please disable tour function first,
- Right now, the screen 2 operation can only be realized on the navigation bard. The operations on the right-click menu are for screen 1 only.



4.3.2.3 Output Screen

Click  to select corresponding window-split mode and output channels.

4.3.2.4 Previous screen/next screen

Click  to go back to the previous screen, click  to go to the next screen.

4.3.2.5 Tour

Click button  to enable tour, the icon becomes , you can see the tour is in process.

Note

Close the tour or the triggered tour operation has cancelled, device restore the previous preview video.

4.3.2.6 PTZ

Click , system goes to the PTZ control interface. Please refer to chapter 4.4.2 PTZ for detailed information.

4.3.2.7 Color

Click button , system goes to the color interface. Please refer to chapter 4.3.6.1 Color for detailed information.

Please make sure system is in one-channel mode.

4.3.2.8 Image



Click , to go to the image interface. Please refer to chapter 4.2.4 Image for detailed information.

Please make sure system is in one-channel mode.

4.3.2.9 Search

Click button , system goes to search interface. Please refer to chapter 4.6.2 Search for detailed information.

4.3.2.10 Broadcast

Click , to go to broadcast interface. Select a group name and then click  to begin broadcast. Please refer to chapter 4.10.5 Broadcast for detailed information.

4.3.2.11 Alarm Status

Click button , system goes to alarm status interface. It is to view device status and channel status. Please refer to chapter 4.10.2.3.1 Alarm status for detailed information.

4.3.2.12 Channel Info

Click button , system goes to the channel information setup interface. It is to view information of the corresponding channel. See Figure 4-62.

CHANNEL INFO							
Channel	Motion Detect	Video Loss	Tampering	Record Status	Bit Rate(Kb/S)	Status	Record Mode
2	--	--	--	■	3934	●	Continuous
4	--	--	--	■	4245	●	Continuous
6	--	--	--	■	6159	●	Continuous

Refresh

Figure 4-62

4.3.2.13 Registration

Click , system goes to the registration interface. Please refer to chapter 4.1.4.6.3 Registration for detailed information.

4.3.2.14 Network

Click , system goes to the network interface. It is to set network IP address, default gateway and etc. Please refer to chapter 4.8 Network for detailed information.

4.3.2.15 HDD Manager

Click , system goes to the HDD manager interface. It is to view and manage HDD information. Please refer to chapter 4.9.1 HDD manager for detailed information.

4.3.2.16 USB Manager

Click , system goes to the USB Manager interface. It is to view USB information, backup and update. Please refer to chapter 4.10.8.1 File backup, chapter 4.10.8.3 Backup log, chapter 4.10.8.2 Import/export, and chapter 0 Upgrade for detailed information.

4.3.3 Preview Control Interface

Move your mouse to the top center of the video of current channel, you can see system pops up the preview control interface. See Figure 4-63. If your mouse stays in this area for more than 6 seconds and has no operation, the control bar automatically hides.



Figure 4-63

1) Instant playback



It is to playback the previous 5-60 minutes record of current channel.

Please go to the Main menu->Setting->->System->General to set real-time playback time.

System may pop up a dialogue box if there is no such record in current channel.

2) Digital zoom

It is to zoom in specified zone of current channel. It supports zoom in function of multiple-channel.

Click button , the button is shown as .

There are two ways for you to zoom in.

- Drag the mouse to select a zone, you can view an interface show as Figure 4-64.



Figure 4-64

- Put the middle button at the center of the zone you want to zoom in, and move the mouse, you can view an interface shown as in Figure 4-65.



Figure 4-65

Right click mouse to cancel zoom and go back to the original interface.

3) Manual record function



It is to back up the video of current channel to the USB device. System cannot backup the video of multiple-channel at the same time.



Click button , system begins recording. Click it again, system stops recording. You can find the record file on the flash disk.

4) Manual Snapshot

Click  to snapshot 1-5 times. The snapshot file is saved on the USB device or HDD. You can go to the Search interface (chapter 4.5) to view.

5) Bidirectional talk

If the connected front-end device supports bidirectional talk function, you can click this button. Click button  to start bidirectional talk function the icon now is shown as . Now the rest bidirectional talk buttons of digital channel becomes null too.

Click  again, you can cancel bidirectional talk and the bidirectional talk buttons of other digital channels become as .

6) Registration

Shortcut menu. Click it to go to the registration interface to add/delete remote device or view its corresponding information. Please refer to chapter 4.2.2 for detailed information.

7) Switch bit streams

Click  to switch the bit stream type of the main stream and sub stream.

- M: Main stream. Its bit streams are big and definition is high. It occupies large network bandwidth suitable for video wall surveillance, storage and etc.
- S: Sub stream. Its definition is low but occupies small network bandwidth. It is suitable for general surveillance, remote connection and etc. Some series products support two sub streams (S1, S2). Refer to chapter 4.2.5.1 Encode for detailed information.

4.3.4 Right Click Menu

After you logged in the device, right click mouse, you can see the short cut menu. Please see Figure 4-66 or Figure 4-67.

- Window split mode: You can select window amount and then select channels.
- Edit view (Sequence): Change channel display sequence on the preview window.
- Customized screen: Set customized screen split mode.
- PTZ: Click it to go to PTZ interface.
- Fisheye (optional): It is to realize fish eye operation.
- Auto focus: It is to set auto focus function. Please make sure the connected network camera supports this function.
- Color setting: Set video corresponding information.
- Search: Click it to go to Search interface to search and playback a record file.
- Record control: Enable/disable record channel.
- Alarm output: It is to set alarm output mode.
- Camera registration: Search and add a remote device.
- Alarm output: Generate alarm output signal manually.
- Main menu: Go to system main menu interface.

Tips:

Right click mouse to go back to the previous interface.



Figure 4-66

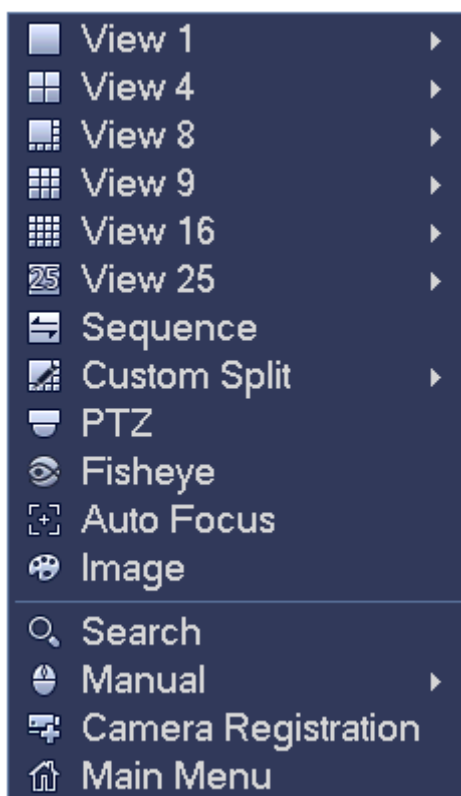

Figure 4-67

4.3.5 Edit View (Sequence)

It is to set customized view layout.







Warning

The preview layout restores default channel layout after Default operation. (Main menu->Setting->General->Default).

Step 1 On the preview interface, right click mouse and then click Edit view. Enter edit view interface. See Figure 4-68.



Note

- Enter edit view interface, device automatically switches to the max split amount mode.
- The channel list on the edit view interface displays the added camera channel number and channel name.  means camera is online.  means camera is offline.
- In case the channel amount has exceeded the device max split amount, the edit view interface can display the max screen number amount and current screen number. In Figure 4-68, click  or , switch the video from other channel.

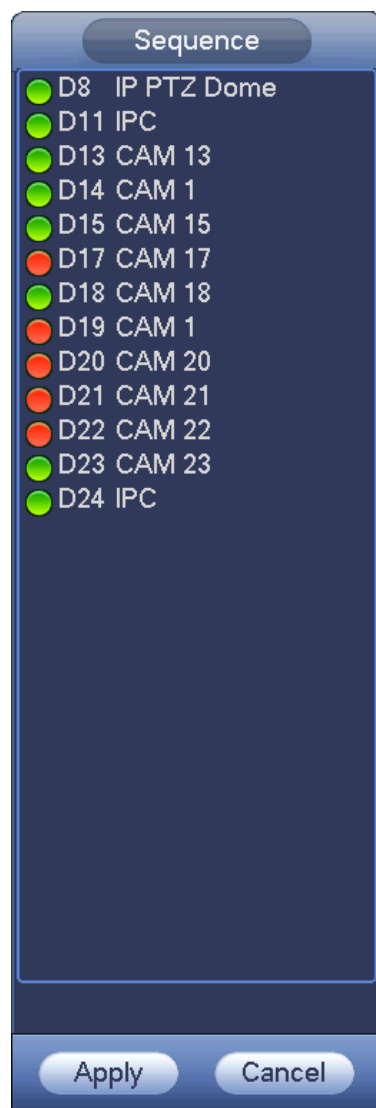

Figure 4-68

- Step 2 On the edit view interface, drag the channel to the desired window, or drag on the preview window to switch the position.
- Check the channel number at the right bottom corner to view the current channel sequence. See Figure 4-69.

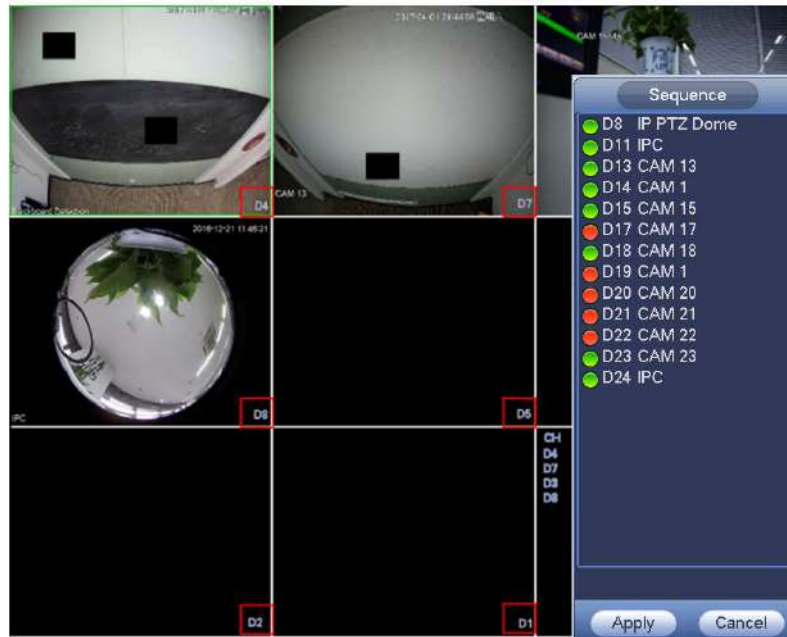

Figure 4-69

- Step 3 Click Apply to save current channel sequence.
- After you change the channel sequence, click Cancel button or right click mouse, device pops up the dialogue box. See Figure 4-70.
- Click OK to save current settings.
 - Click Cancel to exit without saving the settings.

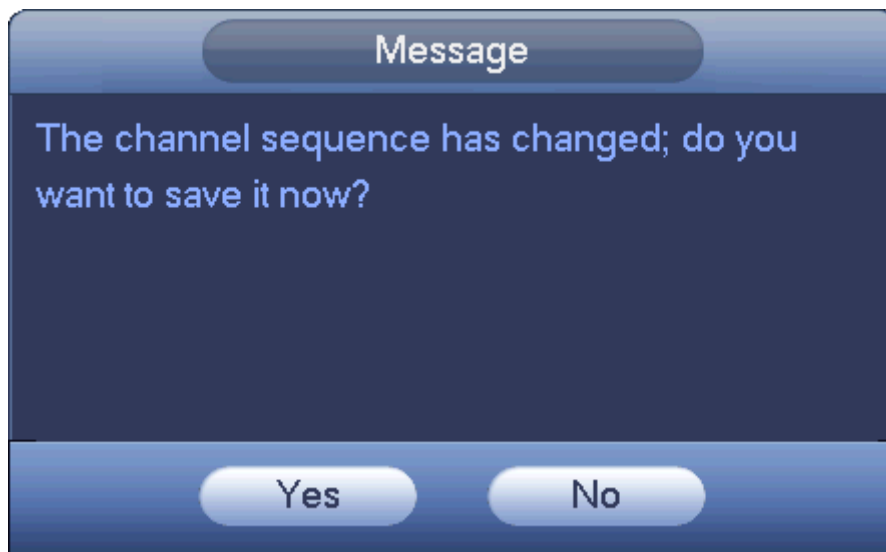

Figure 4-70

4.3.6 Preview Display Effect Setup

4.3.6.1 Video Color

Here you can set hue, brightness, contrast, saturation, gain, white level, color mode and etc. See Figure 4-71.



Figure 4-71

Please refer to the following sheet for detailed information.

Item	Note
Period	There are two periods in one day. You can set different sharpness, brightness, and contrast setup for different periods.
Effective Time	Check the box here to enable this function and then set period time.
Sharpness	The value here is to adjust the edge of the video. The value ranges from 0 to 100. The larger the value is, the clear the edge is and vice versa. Please note there is noise if the value here is too high. The default value is 50 and the recommended value ranges from 40 to 60.
Brightness	It is to adjust monitor window bright. The value ranges from 0 to 100. The default value is 50. The larger the number, the bright the video is. When you input the value here, the bright section and the dark section of the video will be adjusted accordingly. You can use this function when the whole video is too dark or too bright. Please note the video may become hazy if the value is too high. The recommended value ranges from 40 to 60.
Contrast	It is to adjust monitor window contrast. The value ranges from 0 to 100. The default value is 50. The larger the number, the higher the contrast is. You can use this function when the whole video bright is OK but the contrast is not proper. Please note the video may become hazy if the value is too low. If this value is too high, the dark section may lack brightness while the bright section may over exposure. The recommended value ranges from 40 to 60.
Saturation	It is to adjust monitor window saturation. The value ranges from

Item	Note
	0 to 100. The default value is 50. The larger the number, the strong the color is. This value has no effect on the general brightness of the whole video. The video color may become too strong if the value is too high. For the grey part of the video, the distortion may occur if the white balance is not accurate. Please note the video may not be attractive if the value is too low. The recommended value ranges from 40 to 60.
Gain	The gain adjust is to set the gain value. The default value may vary due to different device models. The smaller the value, the low the noise. But the brightness is also too low in the dark environments. It can enhance the video brightness if the value is high. But the video noise may become too clear.
Color mode	It includes several modes such as standard, color, bright, gentle. Select a color mode, the sharpness, brightness, contrast and etc can automatically switch to corresponding setup.

4.3.6.2 Display

From Main Menu->Setting->System->Display->Display, you can go to the following interface. See Figure 4-72.

Here you can set menu and video preview effect. All you operation here does not affect the record file and playback effect.



Figure 4-72

Now you can set corresponding information.

- Display the intelligent rule(s): Check the box to enable IVS function, system can display IVS rule on the preview interface. **Please note this function is for some series only.**
- Resolution: There are five options: 1280×1024 (Default), 1280×720, 1920×1080, 1024×768 and 3840×2160. Please note the system needs to reboot to activate current setup. **Please note 3840×2160 is for some series only.**
- VGA+HDMI2: It is for dual-screen operation. Please select from the dropdown list according to your actual situation. Click Apply button, system needs to restart to activate new setup. For example, 32+4 means for VGA, system max supports 32-window split and for HDMI2, system max supports 4-window split. **Please note this function is for some series only.**
- Transparency: Here is for you to adjust menu transparency. The higher the value is, the better transparent the menu is.
- Time display: You can select to display time or not when system is playback.
- Channel display: You can select to channel name or not when system is playback.
- Image enhance: Check the box; you can optimize the margin of the preview video.
- Original scale: Check the box here to select a corresponding channel; it can restore video original scale.

Click OK button to save current setup.

4.3.6.3 TV adjust



Note

Some series product supports TV adjust function. This function is disabled by default.

From Main Menu->Setting->System->Display->TV adjust; you can go to the following interface. See Figure 4-72. Here you can set margins and brightness.



Figure 4-73

4.3.6.4 Preview Tour Parameters

Set preview display mode, channel display sequence and tour setup.

- Set preview display mode: On the preview interface, right click mouse, you can view right-click menu. Now you can select preview window amount and channel.
- Set channel display mode: On the preview interface, if you want to change channel 1 and channel 16 position, please right click channel 1 video window and then drag to the channel 16 video window, release button, you can change channel 1 and channel 16 position.
- Tour setup: Here you can set preview window channel display mode and interval. Please follow the steps listed below.

From Main menu->Setting->System->Display->Tour, you can see an interface shown as in Figure 4-74.



Here you can set tour parameter.

- Enable tour: Check the box here to enable tour function. The general tour supports all types of window split mode.
- Interval: Input proper interval value here. The value ranges from 1-120 seconds.
- Motion tour type: System support 1/8-window tour. Please note you need to go to the main menu->Setting->Event->Video detect->Motion detect to enable tour function.
- Alarm tour type: System support 1/8-window tour. Please note you need to go to the main menu->Setting->Event->Alarm to enable tour function.
- Window split: It is to set window split mode.



Figure 4-74

Tips

On the navigation bar, click   to enable/disable tour.

Click Save button to save current setup.

4.3.6.5 Customized split

It is to set customized video split mode.

 **Note**

- This function is for some series products. Please refer to the actual product for detailed information.
- Device max supports 5 customized videos.

From Main menu->Setting->System->Display->Custom split, you can see an interface shown as in Figure 4-75.



Figure 4-75

Click  and then click  to select basic mode

In regular mode, drag the mouse in the preview frame; you can merge several small windows to one window so that you can get you desired split mode.

After the setup, the selected window has the red frame. See Figure 4-76.

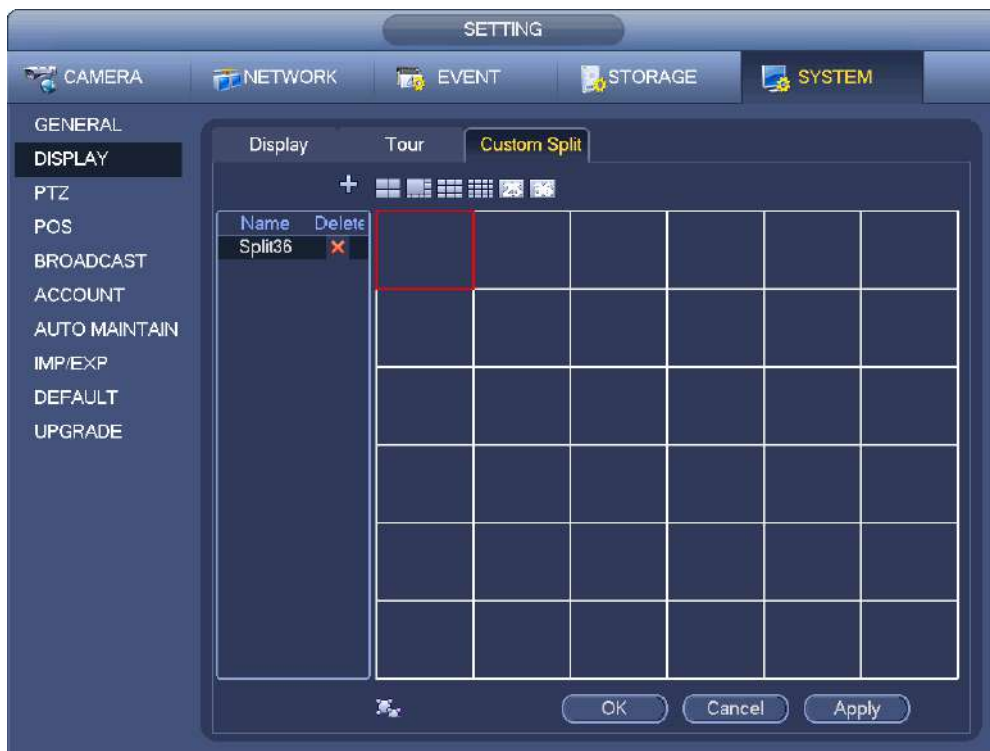



Figure 4-76

Select the merging window, the frame is red; you can click  to cancel the merge to restore regular mode.

Click Save to exit.

After the setup, you can go to the preview window, right click mouse and then select custom split. See Figure 4-77.

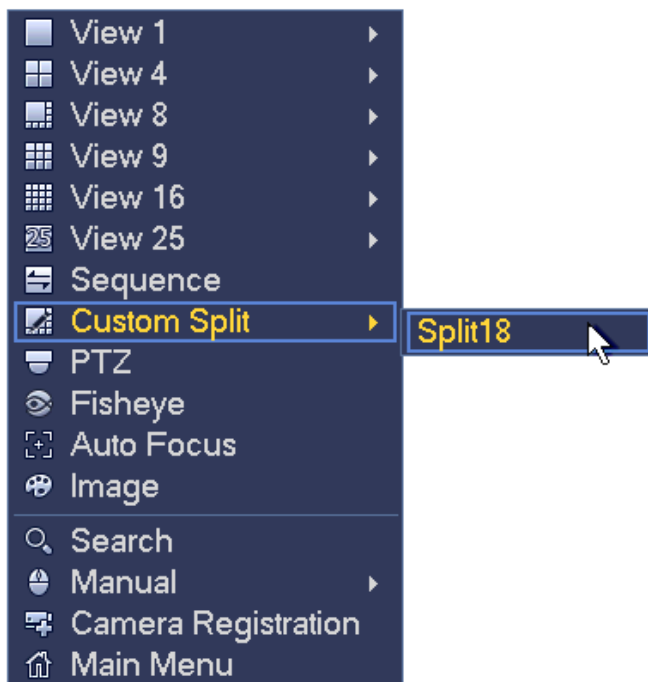

Figure 4-77

4.3.7 Fisheye (Optional)

Please note this function is for some series only.

4.3.7.1 Fisheye de-warp during preview interface

The fisheye camera (panoramic camera) has wide video of angle but its video is serious distorted. The de-warp function can present the proper and vivid video suitable for human eyes.

On the preview interface, select fisheye channel and then right click mouse, you can select fish eye. See Figure 4-78.



Figure 4-78

Now you can see an interface shown as in Figure 4-79. You can set fish eye installation mode and display mode.

Note

- For the non-fish eye channel, system pops up dialogue box to remind you it is not a fish eye channel and does not support de-warp function.
- If system resources are insufficient, system pops up the corresponding dialogue box too.

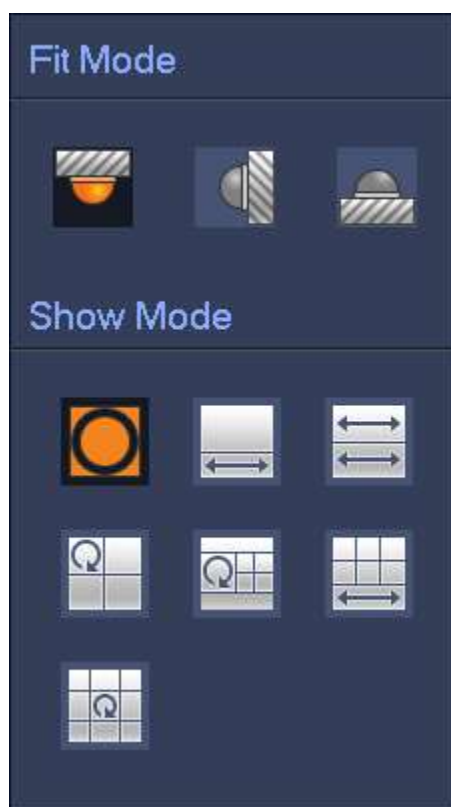













Figure 4-79

There are three installation modes: ceiling mount/wall mount/ground mount. The different installations modes have different de-warp modes.

Please refer to the following sheet for detailed information.

Installation modes	Icon	Note
 (Ceiling mount)  (Ground mount)		360°panorama original view
		1 de-warp window+1 panorama stretching
		2 panorama stretching view
		1 360° panorama view+3 de-warp windows
		1 360°panorama view+4 de-warp windows
		4 de-warp windows+1 panorama stretching
		1 360° panorama view+8 de-warp windows
 (Wall mount)		360°panorama original view
		Panorama stretching



	1 panorama unfolding view+3 de-warp windows
	1 panorama unfolding view +4 de warp windows
	1 panorama unfolding view +8 de warp windows





Figure 4-80

In Figure 4-80, you can adjust the color pane on the left pane or use your mouse to change the position of the small images on the right pane to realize fish eye de-warp.

4.3.7.2 Fish eye de-warp during playback

Step 1 On the main menu, click search button.

Step 2 Select 1-window playback mode and corresponding fish eye channel, click  to play.

Step 3 Right click the , you can go to the de-warp playback interface. For detailed information, please refer to chapter 4.3.7.1 fisheye de-warp during preview.

4.4 PTZ

Note

Before you control the PTZ, please make sure the PTZ decoder and the NVR network connection is OK and the corresponding settings are right.

4.4.1 PTZ Settings

Cable Connection

Please follow the procedures below to go on cable connection

- Connect the dome RS485 port to NVR RS485 port.
- Connect dome video output cable to NVR video input port.
- Connect power adapter to the dome.

In the main menu, from Setting->System->PTZ, you can see an interface is shown as in Figure 4-81. Here you can set the following items:

- Channel: Select the current camera channel.

- PTZ type: There are two types: local/remote. Please select local mode if you are connect RS485 cable to connect to the Speed dome (PTZ). Please select remote mode if you are connecting to the network PTZ camera.
- Protocol: Select corresponding PTZ protocol(such as PELCOD)
- Address: Default address is 1.
- Baud rate: Select corresponding baud rate. Default value is 9600.
- Data bit: Select corresponding data bits. Default value is 8.
- Stop bit: Select corresponding stop bits. Default value is 1.
- Parity: There are three options: odd/even/none. Default setup is none.



Figure 4-81

If you are connecting to network PTZ, the PTZ type shall be remote. See Figure 4-82.



Figure 4-82

4.4.2 PTZ Control

After completing all the setting please click save button. Right click mouse (click “Fn” Button in the front panel or click “Fn” key in the remote control). The interface is shown as in Figure 4-83. Please note you can only go to the PTZ control interface when you are in 1-window display mode.

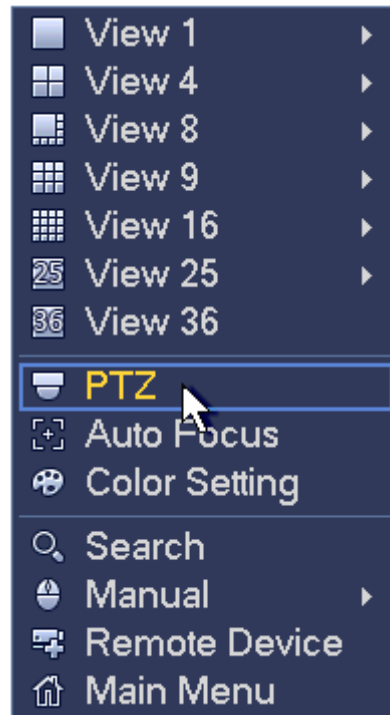

Figure 4-83



The PTZ setup is shown as in See Figure 4-84.

Please note the commend name is grey once device does not support this function.

The PTZ operation is only valid in one-window mode.

Here you can control PTZ direction, speed, zoom, focus, iris, preset, tour, scan, pattern aux function, light and wiper, rotation and etc.

Speed is to control PTZ movement speed. The value ranges from 1 to 8. The speed 8 is faster than speed 1. You can use the remote control to click the small keyboard to set.

You can click  and  of the zoom, focus and iris to zoom in/out, definition and brightness.

The PTZ rotation supports 8 directions. If you are using direction buttons on the front panel, there are only four directions: up/down/left/right.

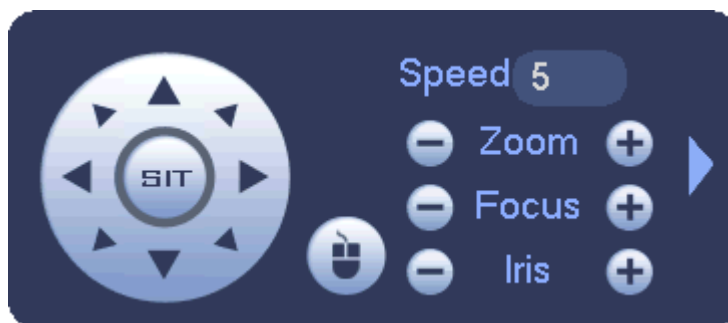













Figure 4-84

In the middle of the eight direction arrows, there is a 3D intelligent positioning key. See Figure 4-85. Please make sure your protocol supports this function and you need to use mouse to control.

Click this key, system goes back to the single screen mode. Drag the mouse in the screen to adjust section size. The dragged zone supports 4X to 16X speeds. It can realize PTZ automatically. The smaller zone you dragged, the higher the speed.



Figure 4-85

Name	Function key	function	Shortcut key	Function key	function	Shortcut key
Zoom		Near			Far	
Focus		Near			Far	
Iris		close			Open	

In Figure 4-84, click  to open the menu, you can set preset, tour, pattern, scan and etc. See Figure 4-86.



Figure 4-86

Please refer to the following sheet for detailed information.

Please note the above interface may vary due to different protocols. The button is grey and cannot be selected once the current function is null.

Right click mouse or click the ESC button at the front panel to go back to the Figure 4-84.

Icon	Function	Icon	Function
	Preset		Flip
	Tour		Reset
	Pattern		Aux
	Scan		Aux on-off button
	Rotate		Go to menu

4.4.2.1 PTZ Function Setup

Click , you can go to the following interface to set preset, tour, pattern, and scan. See Figure 4-87.



Figure 4-87

Preset Setup

In Figure 4-87, click preset button and use eight direction arrows to adjust camera to the proper position.

The interface is shown as in Figure 4-88.
Click Set button and then input preset number.
Click Set button to save current preset.



Figure 4-88

Tour Setup

In Figure 4-87, click tour button.

Input tour value and preset No. Click Add preset button to add current preset to the tour. See Figure 4-89.

Tips

Repeat the above steps to add more presets to the tour. Click Del preset button to remove it from the tour. Please note some protocols do not support delete preset function.



Figure 4-89

Pattern Setup

In Figure 4-87, click Pattern button and input pattern number.

Click Begin button to start direction operation. Or you can go back to Figure 4-84 to operate zoom/focus/iris/direction operation.

In Figure 4-87, click End button.



Figure 4-90

Scan Setup

In Figure 4-87, click Scan button.

Use direction buttons to set camera left limit and then click Left button.

Use direction buttons to set camera right limit and then click Right button. Now the scan setup process is complete.





Figure 4-91

4.4.2.2 Call PTZ Function

Call Preset

In Figure 4-86, input preset value and then click  to call a preset. Click  again to stop call.

Call Pattern

In Figure 4-86, input pattern value and then click  to call a pattern. Click  again to stop call.

Call Tour

In Figure 4-86, input tour value and then click  to call a tour. Click again  to stop call.

Call Scan

In Figure 4-86, input Scan value and then click  to call a tour. Click again  to stop call.

Rotate

In Figure 4-86, click  to enable the camera to rotate.

System supports preset, tour, pattern, scan, rotate, light and etc function.

Note:

- Preset, tour and pattern all need the value to be the control parameters. You can define it as you require.
- You need to refer to your camera user's manual for Aux definition. In some cases, it can be used for special process.

Aux

Click , system goes to the following interface. The options here are defined by the protocol. The aux number is corresponding to the aux on-off button of the decoder. See Figure 4-92.



Figure 4-92

4.5 Record File

Device adopts 24-hour continuous record by default. It supports customized record period and record type. Refer to chapter 4.1.4.6 Schedule for detailed information.

4.6 Playback and Search

4.6.1 Instant Playback

Please refer to chapter 4.3.2 for real-time playback information.

4.6.2 Search Interface

From Main menu->Search, or on the preview interface right click mouse and then select search item, you can go to the following interface. See Figure 4-93 or Figure 4-94.

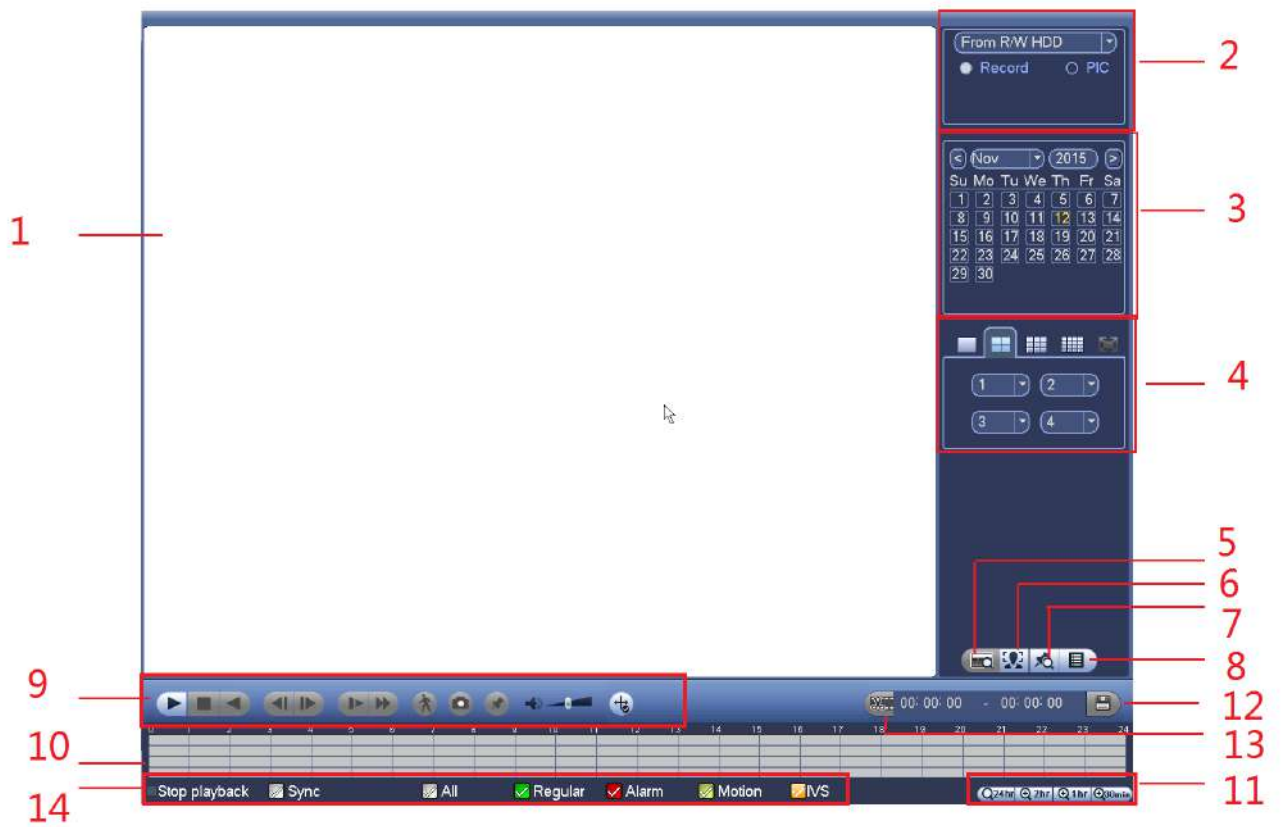

Figure 4-93

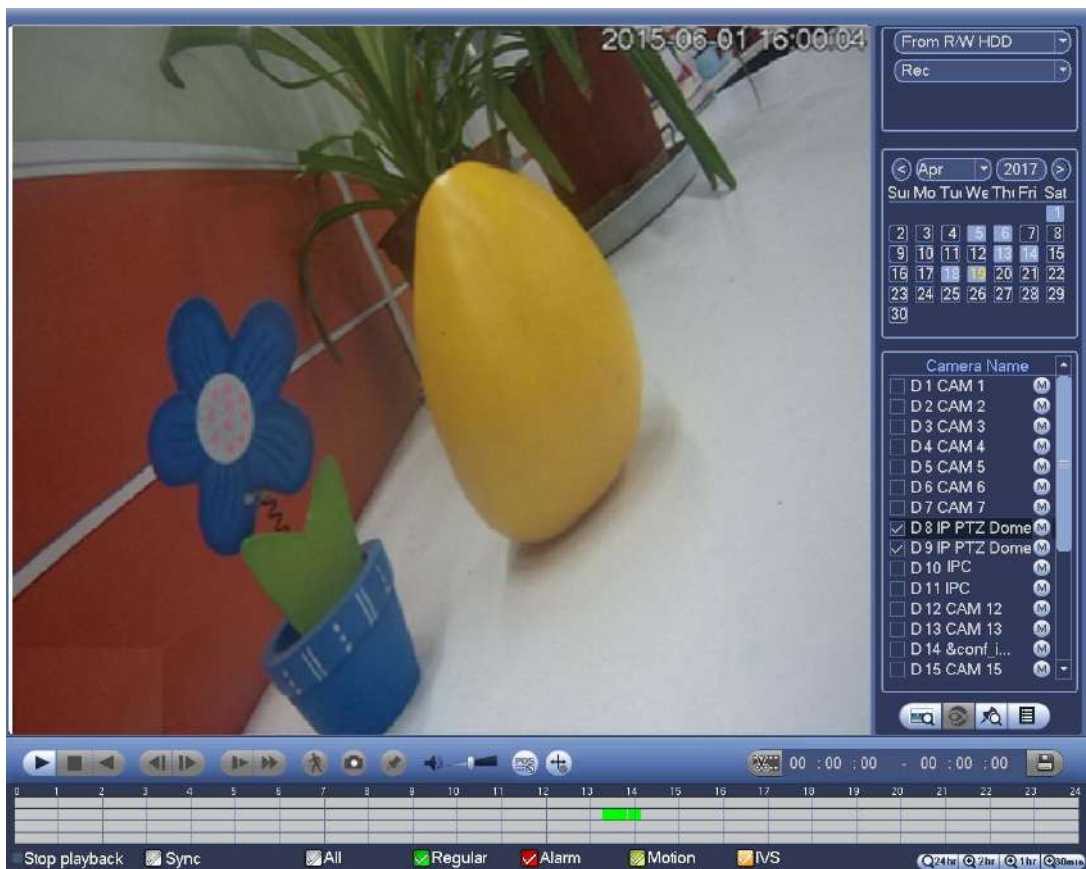

























Figure 4-94

Please refer to the following sheet for more information.

SN	Name	Function
1	Display window	<ul style="list-style-type: none"> ● Here is to display the searched picture or file. ● Support 1/4/9/16-window playback. (It depends on the product channel amount).
2	Search type	<ul style="list-style-type: none"> ● Here you can select to search the picture or the recorded file. ● You can select to play from the read-write HDD, from peripheral device or from redundancy HDD. ● Before you select to play from the peripheral device, please connect the corresponding peripheral device. You can view all record files of the root directory of the peripheral device. Click the Browse button; you can select the file you want to play. <p>Important</p> <ul style="list-style-type: none"> ● Redundancy HDD does not support picture backup function, but it supports picture playback function. You can select to play from redundancy HDD if there are pictures on the redundancy HDD.
3	Calendar	<ul style="list-style-type: none"> ● The blue highlighted date means there is picture or file. Otherwise, there is no picture or file. ● In any play mode, click the date you want to see, you can see the corresponding record file trace in the time bar.
4	Playback mode and channel selection pane.	<ul style="list-style-type: none"> ● Playback mode:1/4/9/16. (It may vary due to different series.) ◇ In 1-window playback mode: you can select 1-X channels (X depends on the product channel amount). ◇ In 4-window playback mode: you can select 4 channels according to your requirement. ◇ In 9-window playback mode, you can switch between 1-8, 9-16 and etc channels. ◇ In 16-window playback mode, you can switch between 1-16, 17-32 and etc channels. ● The time bar will change once you modify the playback mode or the channel option.
5	Card number search	The card number search interface is shown as below. Here you can view card number/field setup bar. You can implement advanced search. Current series product supports this function.
6	Face list	You can search when it is in 1-channel playback mode. Click it, system can filter all human faces and generate human face list. Double click the file; system begins playback the record or image of the corresponding human face.
7	Mark file list button	Click it to go to mark file list interface. You can view all mark information of current channel by time. Please refer to chapter 4.6.4 for detailed information. Please note only the product of this icon supports mark function.

8	File list switch button	<ul style="list-style-type: none"> ● Double click it, you can view the picture/record file list of current day. ● The file list is to display the first channel of the record file. ● The system can display max 128 files in one time. Use the ◀ and ▶ or the mouse to view the file. Select one item, and then double click the mouse or click the ENTER button to playback. ● You can input the period in the following interface to begin accurate search. ● File type:R—regular record; A—external alarm record; M—Motion detect record.  <ul style="list-style-type: none"> ● Lock file. Click the file you want to lock and click the button  to lock. The file you locked will not be overwritten. ● Search locked file: Click the button  to view the locked file. 																		
9	Playback control pane.	<table border="1"> <tr> <td data-bbox="464 779 555 1025">▶/ </td> <td data-bbox="555 779 1520 1025"> Play/Pause  There are three ways for you to begin playback. <ul style="list-style-type: none"> ● The play button ● Double click the valid period of the time bar. ● Double click the item in the file list. In slow play mode, click it to switch between play/pause. </td> </tr> <tr> <td data-bbox="464 1025 555 1070">■</td> <td data-bbox="555 1025 1520 1070">Stop</td> </tr> <tr> <td data-bbox="464 1070 555 1238">◀</td> <td data-bbox="555 1070 1520 1238"> Backward play In normal play mode, left click the button, the file begins backward play. Click it again to pause current play. In backward play mode, click ▶/ to restore normal play. </td> </tr> <tr> <td data-bbox="464 1238 555 1451"> ◀/ ▶ </td> <td data-bbox="555 1238 1520 1451"> In playback mode, click it to play the next or the previous section. You can click continuously when you are watching the files from the same channel. In normal play mode, when you pause current play, you can click ◀ and ▶ to begin frame by frame playback. In frame by frame playback mode, click ▶/ to restore normal playback. </td> </tr> <tr> <td data-bbox="464 1451 555 1574">▶·</td> <td data-bbox="555 1451 1520 1574"> Slow play In playback mode, click it to realize various slow play modes such as slow play 1, slow play 2, and etc. </td> </tr> <tr> <td data-bbox="464 1574 555 1686">▶▶</td> <td data-bbox="555 1574 1520 1686"> Fast forward In playback mode, click to realize various fast play modes such as fast play 1,fast play 2 and etc. </td> </tr> <tr> <td colspan="2" data-bbox="464 1686 1520 1731">Note: The actual play speed has relationship with the software version.</td> </tr> <tr> <td data-bbox="464 1731 555 1821"></td> <td data-bbox="555 1731 1520 1821">Smart search</td> </tr> <tr> <td data-bbox="464 1821 555 1919"></td> <td data-bbox="555 1821 1520 1919">The volume of the playback</td> </tr> </table>	▶/	Play/Pause  There are three ways for you to begin playback. <ul style="list-style-type: none"> ● The play button ● Double click the valid period of the time bar. ● Double click the item in the file list. In slow play mode, click it to switch between play/pause.	■	Stop	◀	Backward play In normal play mode, left click the button, the file begins backward play. Click it again to pause current play. In backward play mode, click ▶/ to restore normal play.	◀/ ▶	In playback mode, click it to play the next or the previous section. You can click continuously when you are watching the files from the same channel. In normal play mode, when you pause current play, you can click ◀ and ▶ to begin frame by frame playback. In frame by frame playback mode, click ▶/ to restore normal playback.	▶·	Slow play In playback mode, click it to realize various slow play modes such as slow play 1, slow play 2, and etc.	▶▶	Fast forward In playback mode, click to realize various fast play modes such as fast play 1,fast play 2 and etc.	Note: The actual play speed has relationship with the software version.			Smart search		The volume of the playback
▶/	Play/Pause  There are three ways for you to begin playback. <ul style="list-style-type: none"> ● The play button ● Double click the valid period of the time bar. ● Double click the item in the file list. In slow play mode, click it to switch between play/pause.																			
■	Stop																			
◀	Backward play In normal play mode, left click the button, the file begins backward play. Click it again to pause current play. In backward play mode, click ▶/ to restore normal play.																			
◀/ ▶	In playback mode, click it to play the next or the previous section. You can click continuously when you are watching the files from the same channel. In normal play mode, when you pause current play, you can click ◀ and ▶ to begin frame by frame playback. In frame by frame playback mode, click ▶/ to restore normal playback.																			
▶·	Slow play In playback mode, click it to realize various slow play modes such as slow play 1, slow play 2, and etc.																			
▶▶	Fast forward In playback mode, click to realize various fast play modes such as fast play 1,fast play 2 and etc.																			
Note: The actual play speed has relationship with the software version.																				
	Smart search																			
	The volume of the playback																			

			<p>Click the snapshot button in the full-screen mode, the system can snapshot 1 picture.</p> <p>System supports custom snap picture saved path. Please connect the peripheral device first, click snap button on the full-screen mode, you can select or create path. Click Start button, the snapshot picture can be saved to the specified path.</p>
			<p>Mark button.</p> <p>Please note this function is for some series product only. Please make sure there is a mark button in the playback control pane.</p> <p>You can refer to chapter 4.6.4 for detailed information.</p>
			<p>In 1-channel playback mode, click it to enable/disable display IVS rule information on the video.</p>
10	Time bar	<ul style="list-style-type: none"> ● It is to display the record type and its period in current search criteria. ● In 4-window playback mode, there are corresponding four time bars. In other playback mode, there is only one time bar. ● Use the mouse to click one point of the color zone in the time bar, system begins playback. ● The time bar is beginning with 0 o'clock when you are setting the configuration. The time bar zooms in the period of the current playback time when you are playing the file. ● The green color stands for the regular record file. The red color stands for the external alarm record file. The yellow stands for the motion detect record file. 	
11	Time bar unit	<ul style="list-style-type: none"> ● The option includes: 、、 和 。The smaller the unit, the larger the zoom rate. You can accurately set the time in the time bar to playback the record. ● The time bar is beginning with 0 o'clock when you are setting the configuration. The time bar zooms in the period of the current playback time when you are playing the file. 	
12	Backup	<ul style="list-style-type: none"> ● Select the file(s) you want to backup from the file list. You can check from the list. Then click the backup button, now you can see the backup menu. System supports customized path setup. After select or create new folder, click the Start button to begin the backup operation. The record file(s) will be saved in the specified folder. ● Check the file again you can cancel current selection. System max supports to display 32 files from one channel. ● After you clip on record file, click Backup button you can save it. ● For one device, if there is a backup in process, you cannot start a new backup operation. 	
13	Clip	<p>It is to edit the file.</p> <ul style="list-style-type: none"> ● Please click  to play the file you want to edit. ● Select clip start time on the time bar and then Click  to start clip. 	

		<ul style="list-style-type: none"> ● Select clip stop time on the time bar and then click  to stop clip. ● Click , system pops up file backup dialogue box for you to save. <p>Please note:</p> <ul style="list-style-type: none"> ● Clip function is for one-channel mode/multiple-channel mode. ● System max supports 1024 files backup at the same time. ● You cannot operate clip operation if there is any file has been checked in the file list.
14	Record type	In any play mode, the time bar will change once you modify the search type.
Other Functions		
15	Motion detection search	<ul style="list-style-type: none"> ● When system is playing, you can select a zone in the window to begin motion detection search. Click the motion detect button to begin play. ● Once the motion detect play has begun, click button again will terminate current motion detect file play. ● There is no motion detect zone by default. ● If you select to play other file in the file list, system switches to motion detect play of other file. ● During the motion detect play process, you cannot implement operations such as change time bar, begin backward playback or frame by frame playback.
16	Other channel synchronization switch to play when playback	When playing the file, click the number button, system can switch to the same period of the corresponding channel to play.
17	Digital zoom	When the system is in full-screen playback mode, left click the mouse in the screen. Drag your mouse in the screen to select a section and then left click mouse to realize digital zoom. You can right click mouse to exit.
18	Manually switch channel when playback	<p>During the file playback process, you can switch to other channel via the dropdown list or rolling the mouse.</p> <p>This function is null if there is no record file or system is in smart search process.</p>

 **Note**

All the operations here (such as playback speed, channel, time and progress) have relationship with hardware version. Some series NVRs do not support some functions or playback speeds.

4.6.2.1 Playback Control

The playback control interface is shown as below. See Figure 2-35.



Figure 4-95

Please refer to the following sheet for more information.

Icon	Function
	Play/Pause In slow play mode, click it to switch between play/pause.
	Backward play <ul style="list-style-type: none"> In normal play mode, left click the button, the file begins backward play. Click it again to pause current play. In backward play mode, click or to restore normal play.
	Display previous frame/next frame. <ul style="list-style-type: none"> When pause the normal playback file, click or to playback frame by frame. In frame by frame playback mode, click or to resume normal playback mode.
	Slow play In playback mode, click it to realize various slow play modes such as slow play 1, slow play 2, and etc.
	Fast forward In playback mode, click to realize various fast play modes such as fast play 1, fast play 2 and etc.
	Adjust the volume of the playback
	Smart search . You can refer to chapter 4.6.3 for detailed information.
	Click the snapshot button in the full-screen mode, the system can snapshot 1 picture. System supports custom snap picture saved path. Please connect the peripheral device first, click snap button on the full-screen mode, you can select or create path. Click Start button, the snapshot picture can be saved to the specified path.
	Mark button. Please note this function is for some series product only. Please make sure there is a mark button in the playback control pane. You can refer to chapter 4.6.4 for detailed information.
	Display/hide POS information. In 1-channel playback mode, you can click it to display/hide POS information on the video.

Icon	Function
	<p>Note This function is for some series only. In 1-channel playback mode, click it to enable/disable display IVS rule information on the video.</p>

4.6.2.2 Clip

This function allows you to clip some footages to a new file and then save to the USB device. See Figure 2-37. Please follow the steps listed below.

Step 1 Select a record first and then click  to playback.

Step 2 Select a time at the time bar and then click  to start clip,

Step 3 Select a time at the time bar and then click  to stop clip,

Step 4 Click , system pops up dialogue box to save the clip file.



Figure 4-96

Note

- Clip function is for one-channel/multiple-channel.
- Max save 1024 files at the same time.
- This function is not for the file already checked in the file list.

4.6.2.3 Record Backup

This function is to backup files you checked in the file list, or the file you just clip.

Click , enter the following interface. See Figure 4-97.

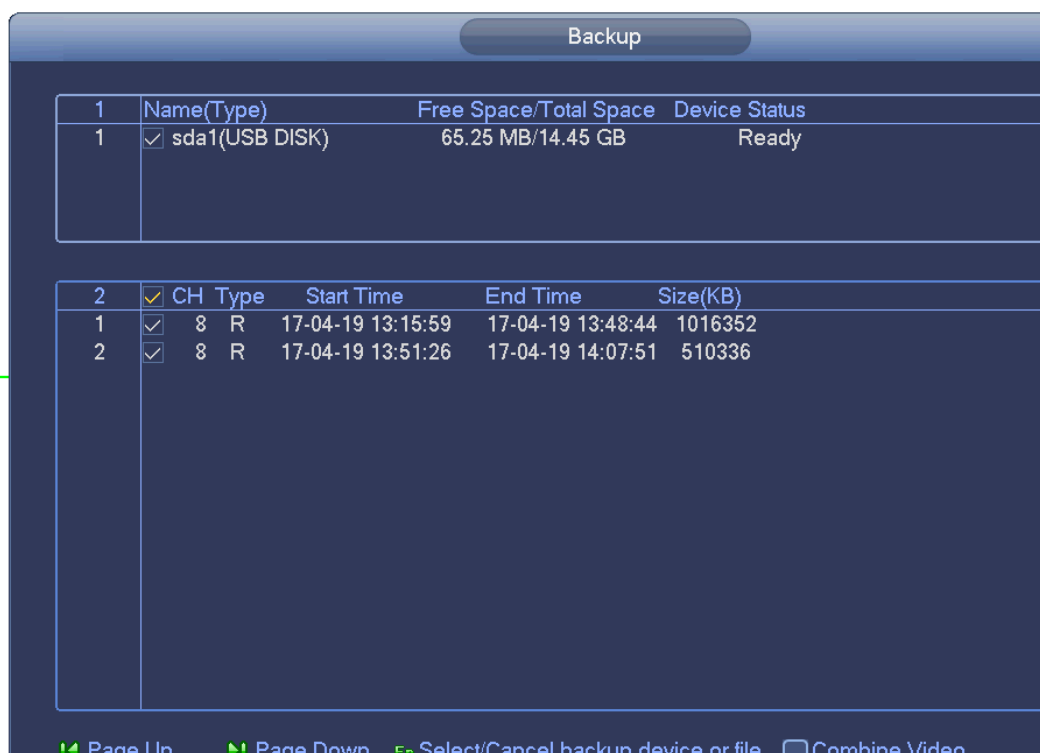

Figure 4-97

Click Backup to begin the process.

4.6.3 Smart Search Playback

Note

This function is for some series product only.

During playback process, it can analyze the motion detect zone in the scene and give the analysis result.

This function is for channel that already enabled motion detect function (main menu->Setting->Event->Video detect->Motion detect).

Please follow the steps listed below.

Step 1 Select a channel to playback video and then click . You can view the grids on the playback video.

Note

- This function is for one-channel playback mode.
- If you are in multiple-channel playback mode, double click a channel first to switch to one-channel playback mode.

Step 2 Left click mouse and then drag to select smart search zones(22*18 (PAL) , 22*15 (NTSC)).

Step 3 Click  to go to smart search and playback. System is going to playback all motion detect record footages.

Step 4 Click  again to stop smart search function.

4.6.4 Mark Playback

Please make sure your purchased device support this function. You can use this function only if you can see the mark playback icon on the Search interface (Figure 4-93 or Figure 4-94).

When you are playback record, you can mark the record when there is important information. After playback, you can use time or the mark key words to search corresponding record and then play. It is very easy for you to get the important video information.

- Add Mark

When system is playback, click Mark button , you can go to the following interface. See Figure 4-98.

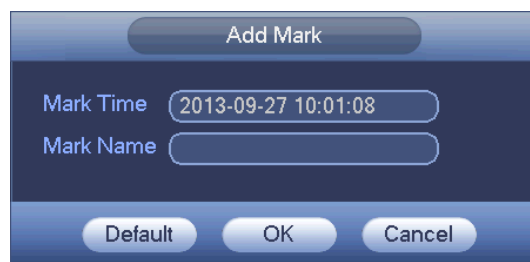



Figure 4-98

- Playback Mark

During 1-window playback mode, click mark file list button  in Figure 4-93 or Figure 4-94, you can go to mark file list interface. Double click one mark file, you can begin playback from the mark time.

- Play before mark time

Here you can set to begin playback from previous N seconds of the mark time.

Note

Usually, system can playbacks previous N seconds record if there is such kind of record file. Otherwise, system playbacks from the previous X seconds when there is such as kind of record.

- Mark Manager

Click the mark manager button  on the Search interface (Figure 4-93 or Figure 4-94); you can go to Mark Manager interface. See Figure 4-99. System can manage all the record mark information of current channel by default. You can view all mark information of current channel by time.

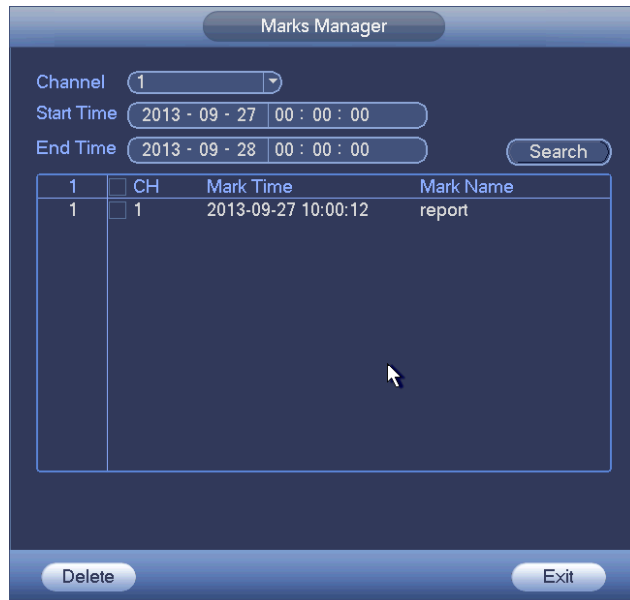

Figure 4-99

- **Modify**

Double click one mark information item, you can see system pops up a dialogue box for you to change mark information. You can only change mark name here.

- **Delete**

Here you can check the mark information item you want to delete and then click Delete button, you can remove one mark item. .



Note

- After you go to the mark management interface, system needs to pause current playback. System resume playback after you exit mark management interface.
- If the mark file you want to playback has been removed, system begins playback from the first file in the list.

4.6.5 Playback Image

Here you can search and play the image. Please follow the steps listed below.

Step 1 From main menu->Search, or on the preview window right click mouse and then click Search, you can go to the search interface.

Step 2 At the top right corner, select image and then input playback interval.

Step 3 Select date and channel, click  to play.

4.6.6 Splice Playback

For the large record file, you can use splice playback function to play the same file in several sections at the same time. It is very convenient for you to find the video footages you desire.

On the main menu, click Search button, or right click mouse and then select Search. You can go to Figure 4-93 or Figure 4-94

On the right pane, check the box to enable splice playback function, and then set channel, date, split mode. The splice playback interface is shown as below. Each section has a small triangle; you can adjust



Figure 4-100



Note

Select split mode, so that the record can be spliced in several sections.

Select splice file.

- Click Playback, system playbacks from the first of current date by default.
- Click time bar, system playbacks from the time you click.
- Click , you can select on the file list.



Note

- The splice playback is for 1-window playback mode.
- System supports 1/4/8/16-split mode. Slight different may be found here. The 4-channel series product supports 4-split mode. The 8-channel series product support 8-split mode. The 16-channel or higher series product supports 16-split mode.
- The min period of each section is 5 minutes. For the record is less than 20 minutes, if you select 4-split mode (or more than 4-split mode), system can auto adjust so that the each section period is 5 minutes. In this situation, some channel may have no video.

4.6.7 Smart Playback

It is to search and playback the IVS file, human face file and plate recognition record.



Note

- There are two types to realize intelligent analytics function.
- ◇ Smart network camera supports intelligent functions: Some smart camera supports the intelligent functions. For NVR, it just displays the intelligent alarm information from the smart network camera and set or playback the record file.
- ◇ NVR supports intelligent functions: The connected network camera does not support intelligent video analytics function. The NVR supports the analytics function.
- This function is to playback the intelligent record file of the smart camera.

4.6.7.1 IVS File

It is to search and playback the IVS record file.

Step 1 From main menu->Operation->Smart Play.

Enter the smart play interface. See Figure 4-101.



Figure 4-101

- Step 2 Select detection type as behavior analytics.
- Step 3 Select a channel.
Enter the following interface. See Figure 4-102.

 **Note**

The IVS function is for one-channel mode only.

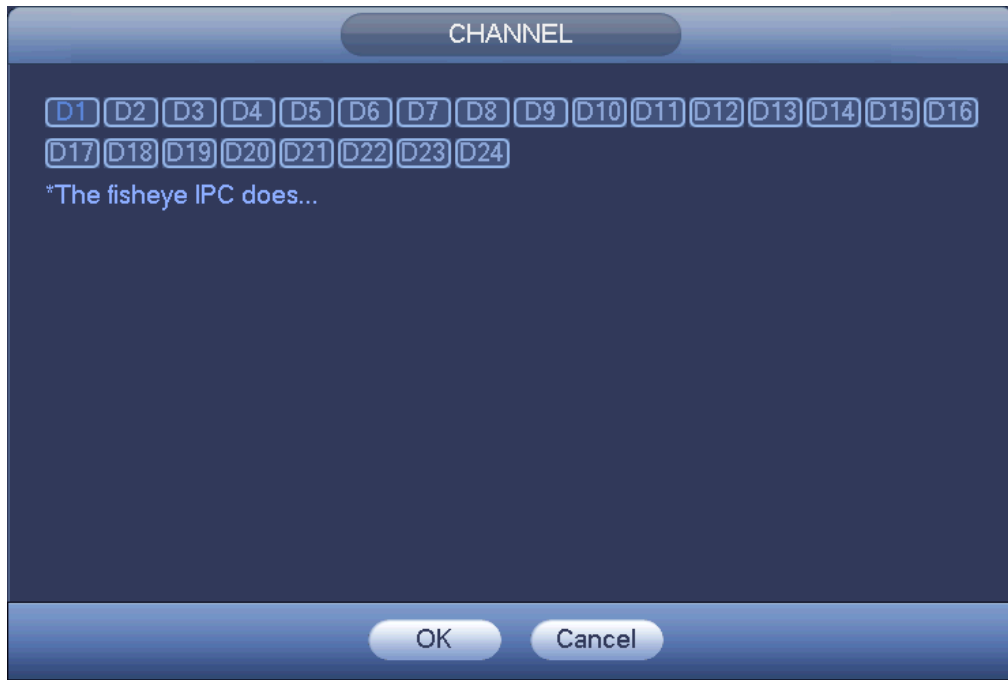

Figure 4-102

- Step 4 Select a channel number and then click OK.
- Step 5 Set detection type as IVS and then set start time and end time.
- Step 6 Click Historic Analysis.
Device displays the corresponding image. See Figure 4-103.

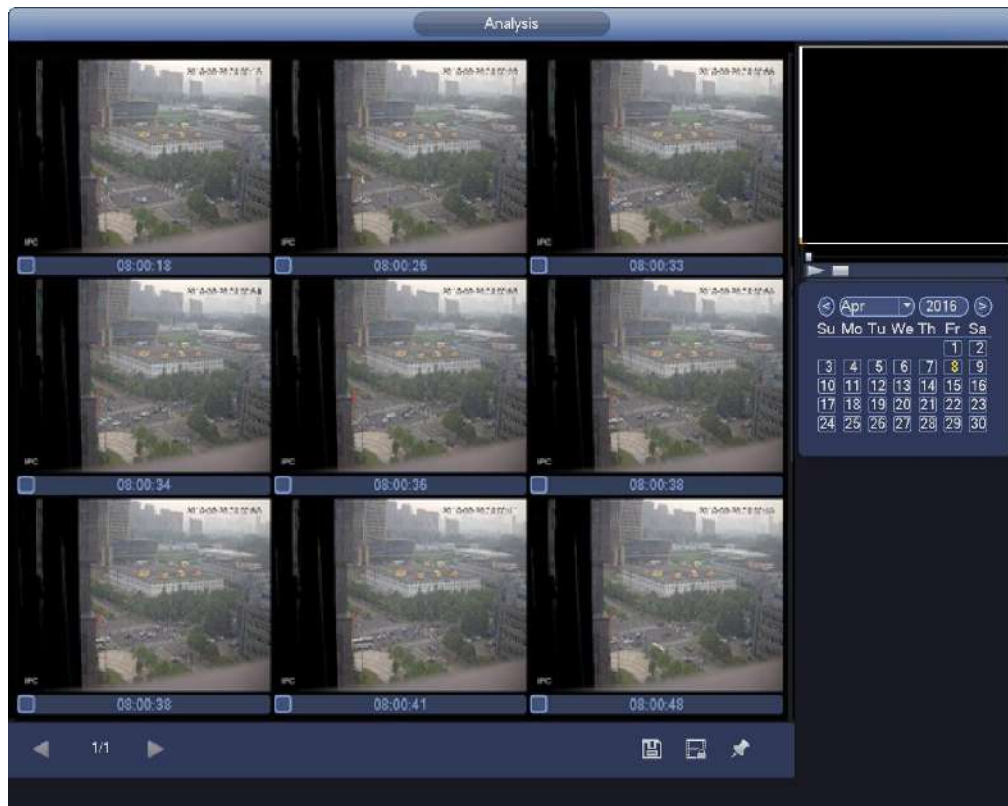





Figure 4-103

- Step 7 Click the image; you can view the record file.

- Select a file and then click , you can save current file to peripheral storage device.
- Select a file and then click , you can lock current file in case it will be overwritten in the future
- Select a file and then click , you can mark the time of the detected event.

4.6.7.2 Search Human Face (Optional)

Human face detection is to analyze the video from the camera and check there is any human face or not. It is to search and playback human face record.

Step 1 From main menu->Operation->Smart Play.

Enter the smart play interface.

Step 2 Select detection type as face detection.

Enter human face detection and playback interface. See Figure 4-104.

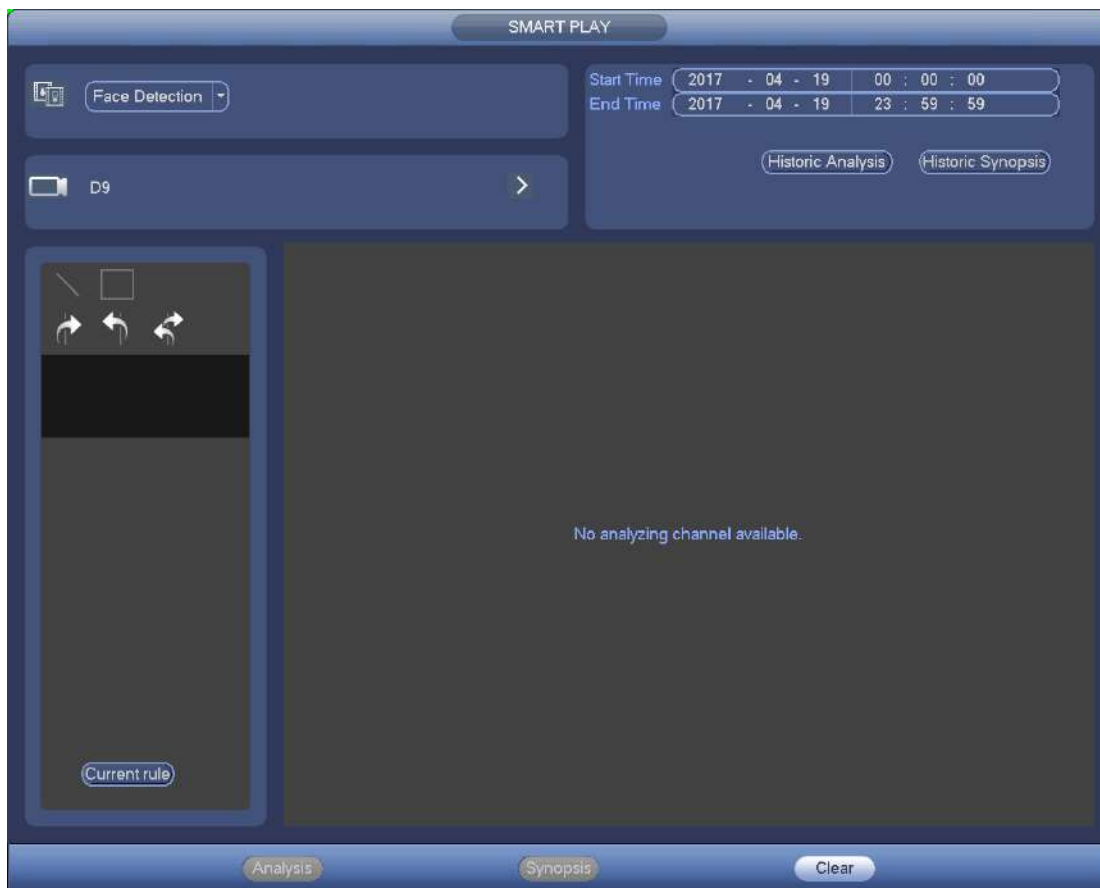

Figure 4-104

Step 3 Set channel, start time and end time.

Step 4 Click Historic analysis.

Device displays the searched human face image. See Figure 4-105.

Note

The following human face has been modified for privacy reason. The actual snapshot image has

high definition.

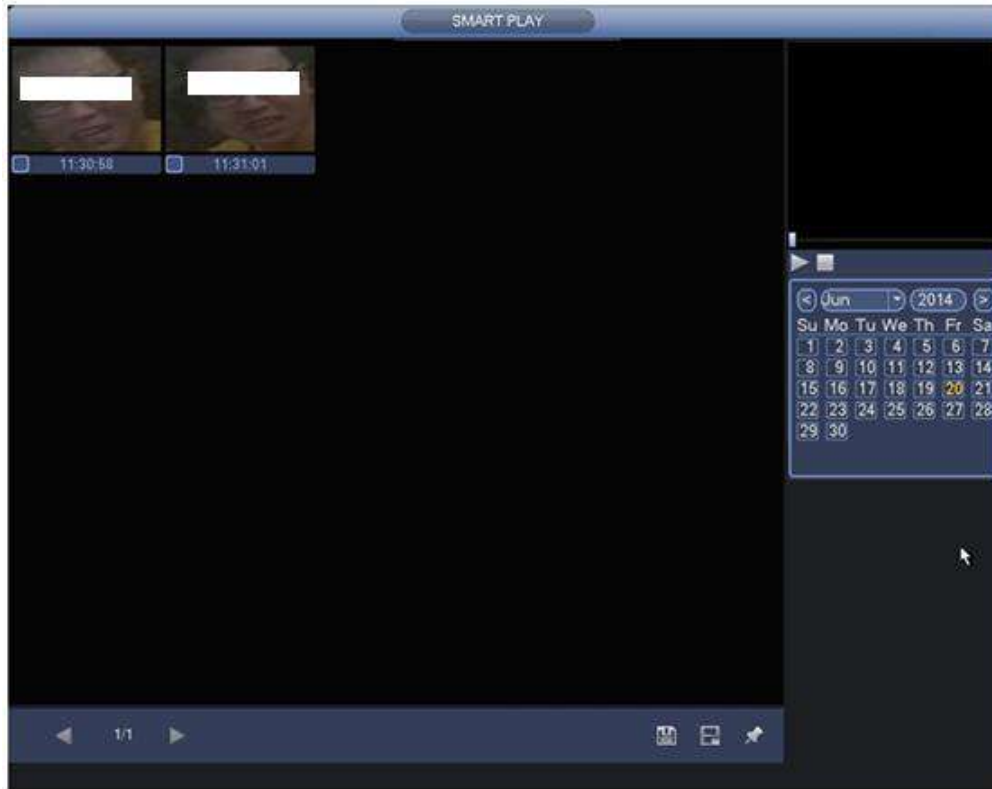





Figure 4-105

Step 5 Click the image; you can view the record file.

- Select a file and then click , you can save current file to peripheral storage device.
- Select a file and then click , you can lock current file in case it will be overwritten in the future
- Select a file and then click , you can mark the time of the detected event.

4.6.7.3 Plate recognition

It is to search and playback the record file containing the plate number.

Step 1 From main menu->Operation->Smart Play.

Enter the smart play interface. See Figure 4-106.

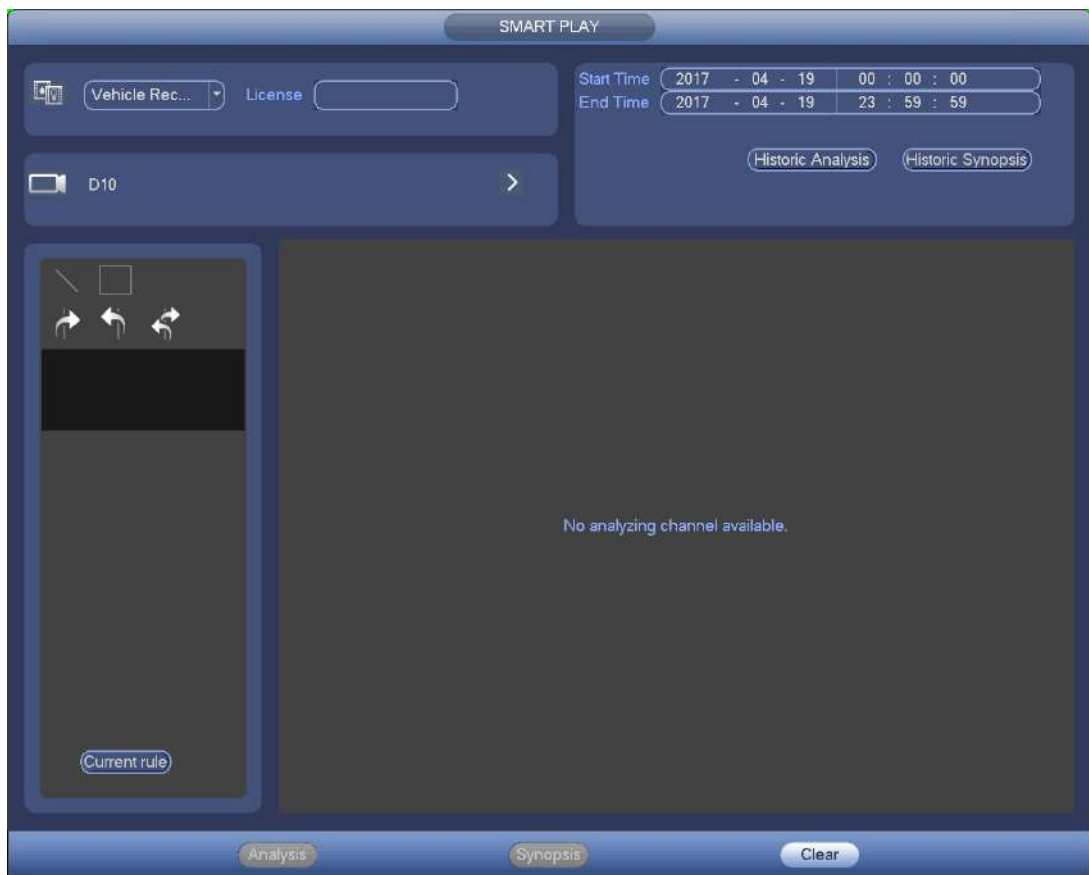

Figure 4-106

Step 2 Set plate number, channel number, start time, end time.

 **Note**

Device supports fuzzy plate number search function.



Device searches all plate numbers by default if you do not input plate number information.

The plate number search and playback function is for one-channel mode only.

Step 3 Click Historic Analytics.

Device displays the corresponding image.

Step 4 Click the image; you can view the record file.

- Select a file and then click , you can save current file to peripheral storage device.
- Select a file and then click , you can lock current file in case it will be overwritten in the future
- Select a file and then click , you can mark the time of the detected event.

4.6.8 File List

Click , system displays file list. It displays the first channel of the record. See Figure 4-107.

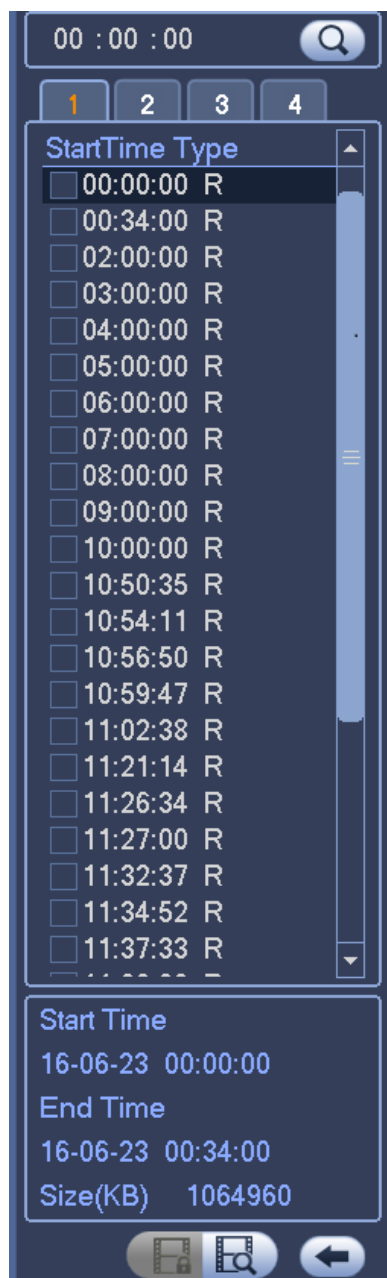





Figure 4-107

- Check a file name, double click file or click  to play.
- Input accurate time at the top column, you can search records of current day.
- System max displays 128 record files in one list.
- Click  to go back to the calendar/channel selection interface.

Lock or Unlock File

In Figure 4-107, select a file first and then click . You can lock it in case it is overwritten in the future.

Note

NVR cannot lock a file when it is writing or overwriting.

Click  you can view the locked file. See Figure 4-108.

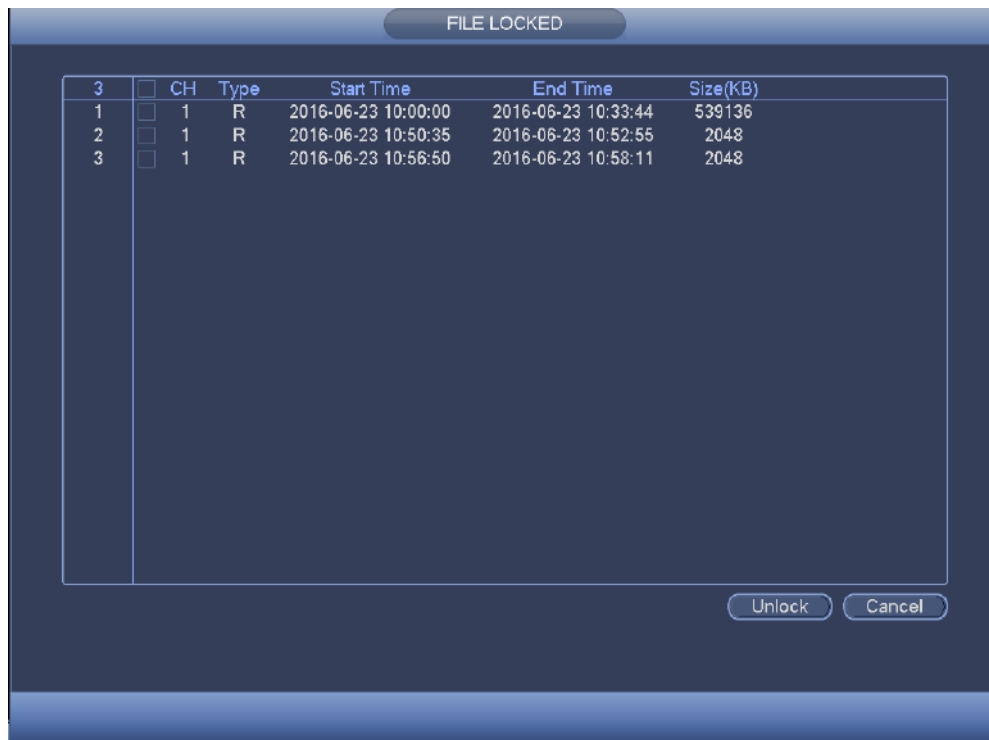

Figure 4-108

Select a file in the above figure and then click Unlock, you can unlock it.

4.6.9 Other Aux Functions

4.6.9.1 Digital Zoom

In 1-window playback mode, left click mouse to select any zone on the screen, you can zoom in current zone. Right click mouse to exit.

4.6.9.2 Switch Channel

During playback mode, select from the dropdown list to switch playback channel. This function is not for the channel of no record. The smart search channel does not support this function either.

4.7 Event Manager

4.7.1 Video Detect

The video detect adopts the computer image and graphics process technology. It can analyze the video and check there is considerable changing degree or not. Once video has changed considerably (such as there is any moving object, video is distorted), system can trigger the corresponding alarm activation operations.





In the main menu, from Setting to Detect, you can see motion detect interface. See Figure 4-109. There are four detection types: motion detection, video loss, tampering and scene changing.

4.7.1.1 Motion Detect

After analysis video, system can generate a motion detect alarm when the detected moving signal reached the sensitivity you set here.

Detection menu is shown as below. See Figure 4-109.

- Event type: From the dropdown list you can select motion detection type.
- Channel: Select a channel from the dropdown list to set motion detect function.

- Enable: Check the box here to enable motion detect function.
 - Region: Click select button, the interface is shown as in Figure 4-110. Here you can set motion detection zone. There are four zones for you to set. Please select a zone first and then left drag the mouse to select a zone. The corresponding color zone displays different detection zone. You can click Fn button to switch between the arm mode and disarm mode. In arm mode, you can click the direction buttons to move the green rectangle to set the motion detection zone. After you completed the setup, please click ENTER button to exit current setup. Do remember click save button to save current setup. If you click ESC button to exit the region setup interface system will not save your zone setup.
 - Sensitivity: System supports 6 levels. The sixth level has the highest sensitivity.
 - Anti-dither: Here you can set anti-dither time. The value ranges from 5 to 600s. The anti-dither time refers to the alarm signal lasts time. It can be seem as the alarm signal activation stays such as the buzzer, tour, PTZ activation, snapshot, channel record. The stay time here does not include the latch time. During the alarm process, the alarm signal can begin an anti-dither time if system detects the local alarm again. The screen prompt, alarm upload, email and etc will not be activated. For example, if you set the anti-dither time as 10 second, you can see the each activation may last 10s if the local alarm is activated. During the process, if system detects another local alarm signal at the fifth second, the buzzer, tour, PTZ activation, snapshot, record channel will begin another 10s while the screen prompt, alarm upload, email will not be activated again. After 10s, if system detects another alarm signal, it can generate an alarm since the anti-dither time is out.
 - Period: Click set button, you can see an interface is shown as in Figure 4-112. Here you can set motion detect period. System only enables motion detect operation in the specified periods. It is not for video loss or the tampering. There are two ways for you to set periods. Please note system only supports 6 periods in one day.
- ✧ In Figure 4-112, Select icon  of several dates, all checked items can be edited together. Now the icon is shown as . Click  to delete a record type from one period.
- ✧ In Figure 4-112. Click button  after one date or a holiday, you can see an interface shown as in Figure 4-113. There are four record types: regular, motion detection (MD), Alarm, MD & alarm.
- Alarm output: when an alarm occurs, system enables peripheral alarm devices.
 - Latch: when motion detection complete, system auto delays detecting for a specified time. The value ranges from 1-300(Unit: second)
 - Show message: System can pop up a message to alarm you in the local host screen if you enabled this function.
 - Alarm upload: System can upload the alarm signal to the network (including alarm center) if you enabled current function.
 - Send email: System can send out email to alert you when an alarm occurs.
 - Record channel: System auto activates motion detection channel(s) to record once an alarm occurs. Please make sure you have set MD record in Schedule interface(Main Menu->Setting->Schedule) and schedule record in manual record interface(Main Menu->Advanced->Manual Record)
 - PTZ activation: Here you can set PTZ movement when an alarm occurs. Such as go to preset, tour & pattern when there is an alarm. Click “select” button, you can see an interface is shown as in Figure 4-111.

- Record Delay: System can delay the record for specified time after alarm ended. The value ranges from 10s to 300s.
- Tour: Here you can enable tour function when alarm occurs. System one-window tour.
- Snapshot: You can enable this function to snapshot image when a motion detect alarm occurs.
- Video matrix Check the box here to enable this function. When an alarm occurs, SPOT OUT port displays device video output. It displays video (1-window tour) from alarm activation channel you select at the Record channel item.
- Buzzer: Highlight the icon to enable this function. The buzzer beeps when alarm occurs.

Please highlight icon  to select the corresponding function. After all the setups please click save button, system goes back to the previous menu.

Note:

In motion detection mode, you cannot use copy/paste to set channel setup since the video in each channel may not be the same.

In Figure 4-110, you can left click mouse and then drag it to set a region for motion detection. Click Fn to switch between arm/withdraw motion detection. After setting, click enter button to exit.



Figure 4-109

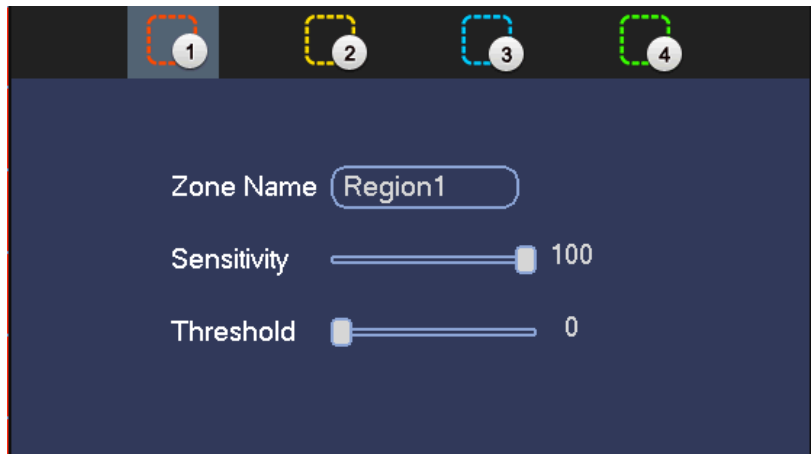

Figure 4-110



Figure 4-111

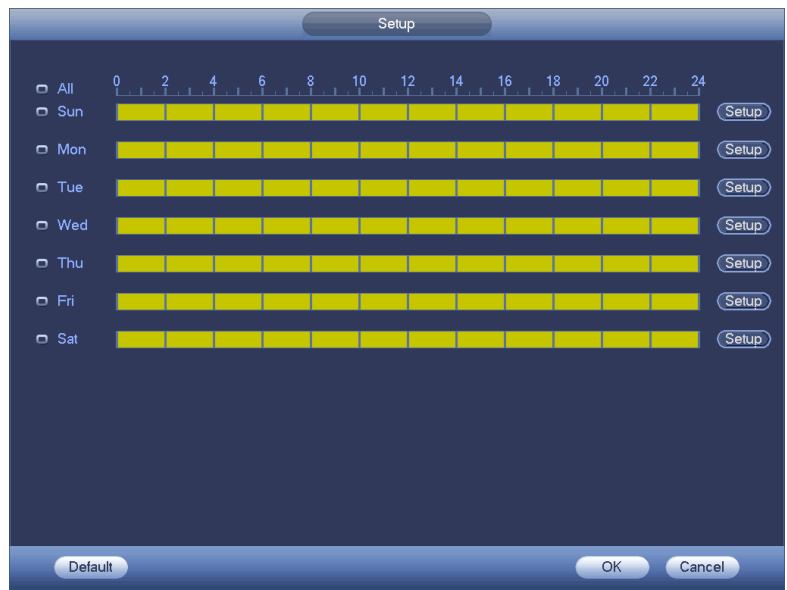

Figure 4-112



Figure 4-113

Motion detect here only has relationship with the sensitivity and region setup. It has no relationship with other setups.

4.7.1.2 Tampering

When someone viciously masks the lens, or the output video is in one-color due to the environments light change, the system can alert you to guarantee video continuity. Tampering interface is shown as in Figure 4-114. You can enable “Alarm output” or “Show message” function when tampering alarm occurs.

- Sensitivity: The value ranges from 1 to 6. It mainly concerns the brightness. The level 6 has the higher sensitivity than level 1. The default setup is 3.

Tips:

You can enable preset/tour/pattern activation operation when video loss occurs.

Please refer to chapter 4.7.1.1 motion detection for detailed information.



Note

- In Detect interface, copy/paste function is only valid for the same type, which means you cannot copy a channel setup in video loss mode to tampering mode.
- About Default function. Since detection channel and detection type may not be the same, system can only restore default setup of current detect type. For example, if you click Default button at the tampering interface, you can only restore default tampering setup. It is null for other detect types.
- System only enables tampering function during the period you set here. It is null for motion detect or video loss type.

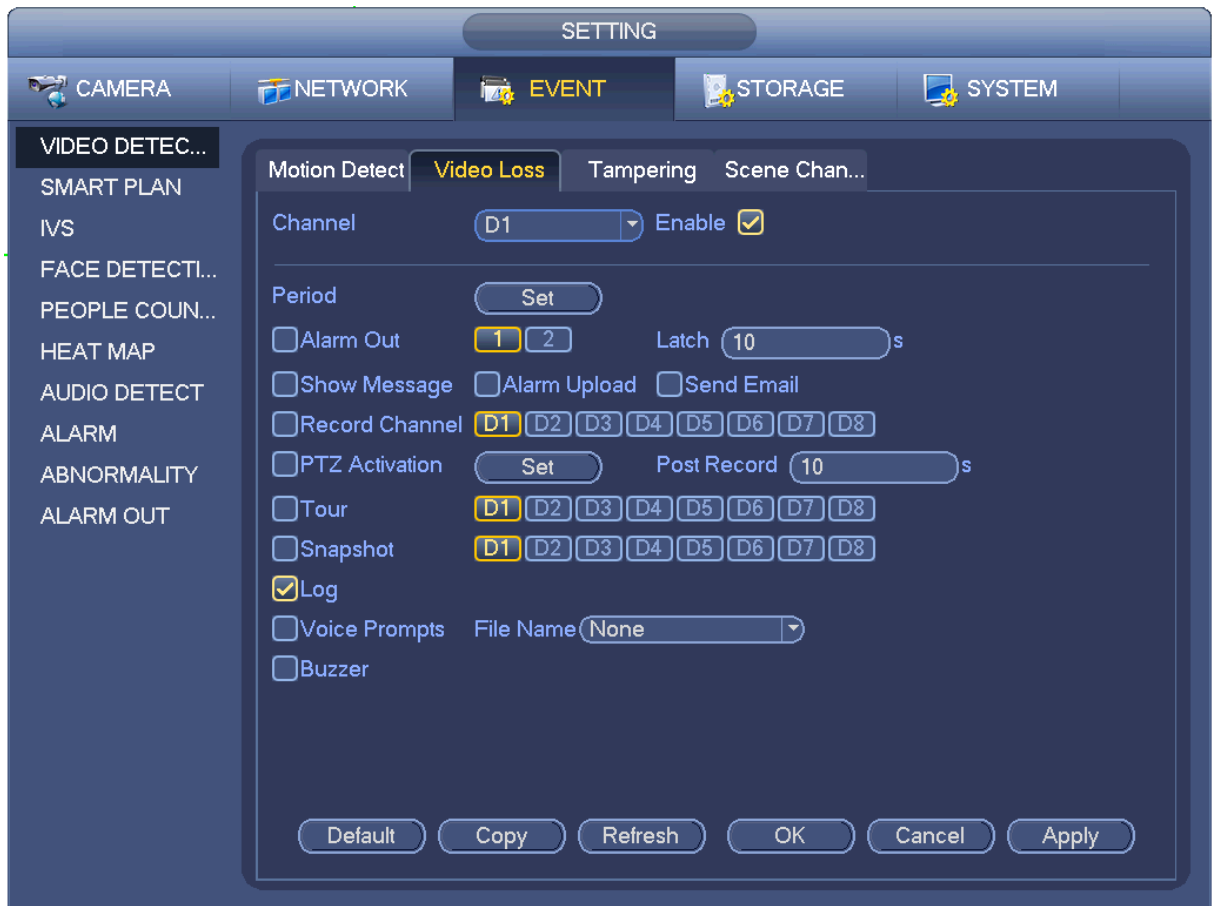

Figure 4-114

4.7.1.3 Video Loss

After connected the system to the remote device, system can generate an alarm once the remote device has lost the video. System can trigger the corresponding alarm operations.

In Figure 4-109, select video loss from the type list. You can see the interface is shown as in Figure 4-115. This function allows you to be informed when video loss phenomenon occurred. You can enable alarm output channel and then enable show message function.

You can refer to chapter 4.7.1.1 Motion detect for detailed information.

Tips:

You can enable preset/tour/pattern activation operation when video loss occurs.



Figure 4-115

4.7.1.1 Scene Changing

When the detected scene has changed, system can generate an alarm.

From main menu->Setting->Event->Video detect->Scene change, the interface is shown as in Figure 4-116.

Please refer to chapter 4.7.1.1Motion detect for detailed information.



Figure 4-116

4.7.2 Smart Plan

The smart plan is for the smart network camera. If you do not set a rule here, you cannot use the intelligent functions in IVS (Chapter 4.7.3), Face detection (Chapter 4.7.4) and People counting (Chapter 4.7.5) when you are connecting to a smart network camera.

There are two types to realize intelligent analytics function.

Note

- Smart network camera supports intelligent functions: Some smart camera supports the intelligent functions. For NVR, it just displays the intelligent alarm information from the smart network camera and set or playback the record file.
- NVR supports intelligent functions: The connected network camera does not support intelligent video analytics function. The NVR supports the analytics function.

In this interface, you can quickly add an intelligent rule for one preset. The intelligent rule includes human face detection, behavior analytics and people counting.

From main menu->Setting->Event->Smart plan, the interface is shown as below. See Figure 4-117.



Figure 4-117

Please select a channel number and a preset. Click Add.
The preset is now on the list. See Figure 4-118.

 **Note**

Some smart camera does not need to add the preset. Please refer to the actual product for detailed information.

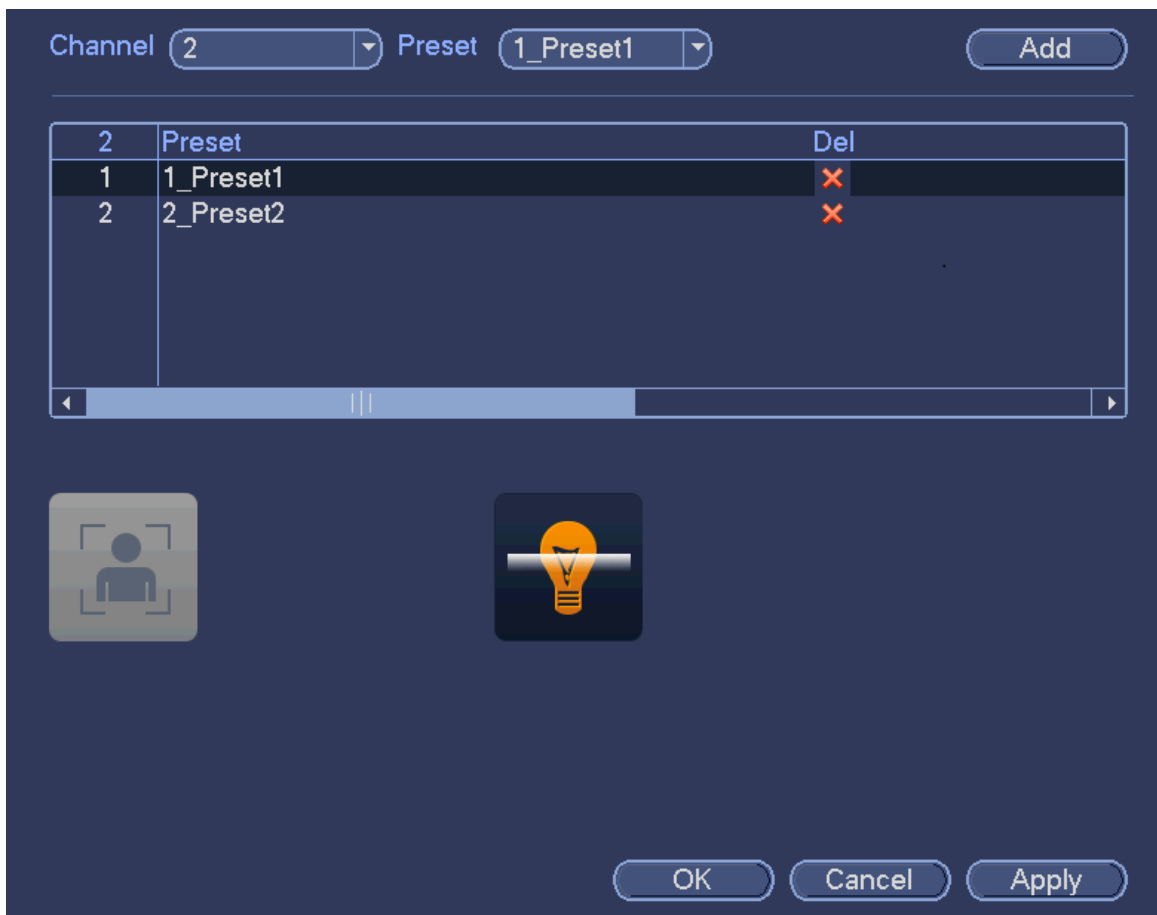

Figure 4-118

Select a smart plant from the dropdown list and then click the corresponding intelligent plan icon. See Figure 4-118.

 **Note**

- The NVR supports general behavior analytics (IVS), human face detection, heat map, and people counting. Different network camera supports different smart plans. Please refer to the actual product for detailed information.
- The general behavior analytics (IVS) and human face detection function cannot be valid at the same time. For example, when add the IVS plan to the preset 1, the human face detection icon becomes grey.

Click OK to complete the setup.

4.7.3 IVS (General Behavior Analytics) (Optional)

The general behavior analysis refers to the system to analyze and process the video and extract the key information from the video. Once the video can match the previously set detection rule, system can trigger the corresponding alarm operations.

 **Note**

- This function is for some series product only. Please refer to the actual product for detailed information.
- The IVS function and the human face detection function cannot be valid at the same time.

The IVS function environment shall meet the following requirements:

- The object total size shall not be more than 10% of the whole video.
- The object size on the video shall not be more than 10pixels*10 pixels. The abandoned object size shall be more than 15pixels*15 pixels (CIF resolution). The object width shall not be more than 1/3 of the video height and width. The recommended height is 10% of the video.
- The object and the background brightness different shall be more than 10 grey levels.
- The object shall remain on the video for more than 2 seconds. The moving distance is larger than its own width and shall not be smaller than 15pixels (CIF resolution).
- The surveillance environment shall not be too complicated. The IVS function is not suitable for the environment of too many objects or the changing light.
- The surveillance environment shall not contain glasses, reflection light from the ground, and water. Free of tree branches, shadow, mosquito and bugs. Do not use the IVS function in the backlight environment, avoid direct sunlight.

From main menu->Setting->Event->Behavior Analytics, you can go to the behavior analytics interface. Here you can set general behavior analytics rule. System can generate an alarm as the mode you previously set once there is any object violates the rule. See Figure 4-119.



Figure 4-119

Select a channel from the dropdown list.

Click Add button to add a rule and then select a rule type from the dropdown list.

Set corresponding parameters.

Click Apply button to complete the setup.

4.7.3.1 Tripwire (Optional)

System generates an alarm once there is any object crossing the tripwire in the specified direction.

- The tripwire supports customized setup. It can be a straight line or a curve.
- Support one-direction or dual-direction detection.

- Support several tripwires at the same scene suitable for complicated environment.
- Support object size filter.

From main menu->Setting->Event->Behavior analytics, the interface is shown as below. See Figure 4-120.



Figure 4-120



Click Draw button  to draw the tripwire. See Figure 4-121.



Figure 4-121

Select direction, and then input customized rule name.

- Preset: Select a preset you want to use behavior analytics.
- Name: Input customized rule name.
- Direction (A→B/B→A/A↔B): System can generate an alarm once there is any object crossing in the specified direction.

- Target filter: Click , you can set filter object size. Each rule can set two sizes (min size/max size).
Once the object is smaller than the min size or larger than the max size, there is no alarm. Please make sure the max size is larger than the min size.

Now you can draw a rule. Left click mouse to draw a tripwire. The tripwire can be a direct line, curve or polygon. Right click mouse to complete.

Tips

Click  to delete the corresponding rule.

Click , you can see the following interface. See Figure 4-122.

You can refer to the following information to set other parameters.

- Channel: Select a channel from the dropdown list to set tripwire function.
- Enable: Check the box here to enable tripwire function.
- Rule: input customized rule name here.
- Period: Click set button, you can see an interface is shown as in Figure 4-112. Here you can set tripwire period. System only enables tripwire operation in the specified periods. There are two ways for you to set periods. Please note system only supports 6 periods in one day.

✧ In Figure 4-112, Select icon  of several dates, all checked items can be edited together.

Now the icon is shown as . Click  to delete a record type from one period.

✧ In Figure 4-112. Click button  after one date or a holiday, you can see an interface shown as in Figure 4-113.

- Alarm output: when an alarm occurs, system enables peripheral alarm devices.
- Latch: when tripwire complete, system auto delays detecting for a specified time. The value ranges from 1-300(Unit: second)
- Show message: System can pop up a message to alarm you in the local host screen if you enabled this function.
- Alarm upload: System can upload the alarm signal to the network (including alarm center) if you enabled current function.
- Send email: System can send out email to alert you when an alarm occurs.
- Record channel: System auto activates tripwire channel(s) to record once an alarm occurs. Please make sure you have set intelligent record in Schedule interface(Main Menu->Setting->Schedule) and schedule record in manual record interface(Main Menu->Advanced->Manual Record)
- PTZ activation: Here you can set PTZ movement when an alarm occurs. Such as go to preset, tour & pattern when there is an alarm. Click “select” button, you can see an interface is shown as in Figure 4-111.
- Record Delay: System can delay the record for specified time after alarm ended. The value ranges from 10s to 300s.
- Tour: Here you can enable tour function when an alarm occurs. System one-window tour.
- Snapshot: You can enable this function to snapshot image when a motion detect alarm occurs.
- Buzzer: Highlight the icon to enable this function. The buzzer beeps when an alarm occurs.



Figure 4-122



Figure 4-123

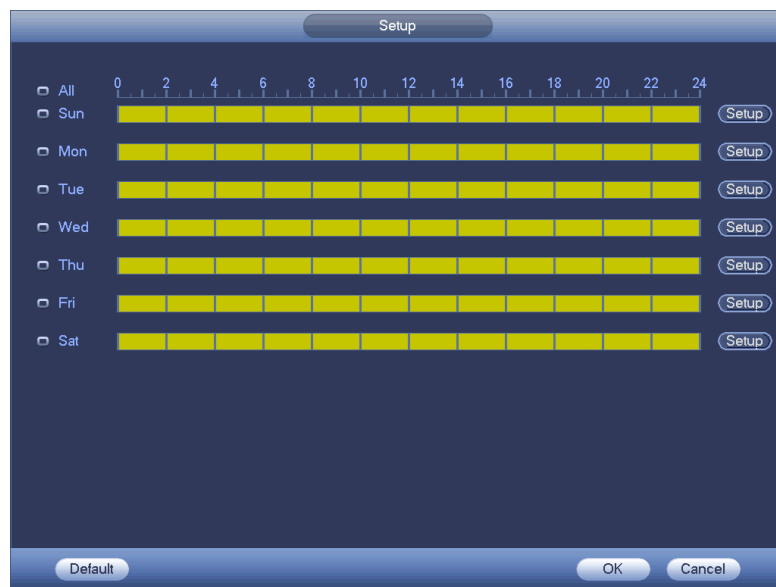

Figure 4-124



Figure 4-125

After you set the corresponding parameters, click OK button in Figure 4-122., and then click the Apply button in Figure 4-120 to complete the setup.

4.7.3.2 Intrusion (Cross warning zone) (Optional)

System generates an alarm once there is any object entering or exiting the zone in the specified direction. From main menu->Setting->Event->Behavior analytics, click Add button and then select type as intrusion, the interface is shown as below. See Figure 4-126.

- System supports customized area shape and amount.
- Support enter/leave/both detection.
- Can detect the moving object operation in the specified zone, customized trigger amount and staying time.
- Support objects filter function.



Figure 4-126

Click draw button  to draw the zone. See Figure 4-127.

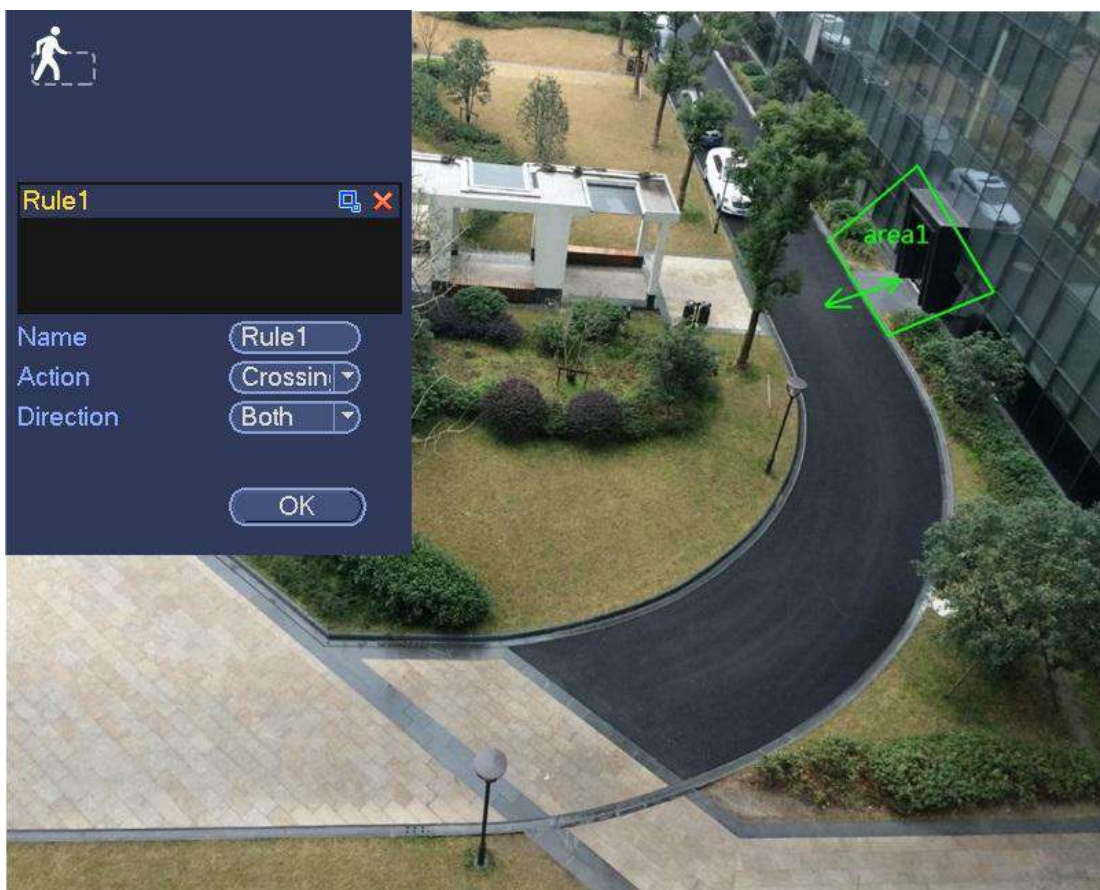



Figure 4-127

Select direction, and then input customized rule name.

- Preset: Select a preset you want to use behavior analytics.
- Name: Input customized rule name.
- Direction (A→B/B→A/A↔B): System can generate an alarm once there is any object crossing in the specified direction.
- Target filter: Click , you can set filter object size. Each rule can set two sizes (min size/max size).

Once the object is smaller than the min size or larger than the max size, there is no alarm. Please make sure the max size is larger than the min size.

Now you can draw a rule. Left click mouse to draw a warning zone. Right click mouse to complete the setup.

Tips

Click  to delete the corresponding rule.

Click , you can refer to chapter 4.7.3.1 to set other parameters.

Click Apply to complete the setup.

4.7.3.3 Abandoned Object Detect (Optional)

System generates an alarm when there is abandoned object in the specified zone.

From main menu->Setting->Event->Behavior analytics, select the type as abandoned object, the object interface is shown as below. See Figure 4-128.

- System supports customized area shape and amount.
- Support duration setup.
- Support objects filter function.



Figure 4-128

Click draw button  to draw the zone. See Figure 4-129.

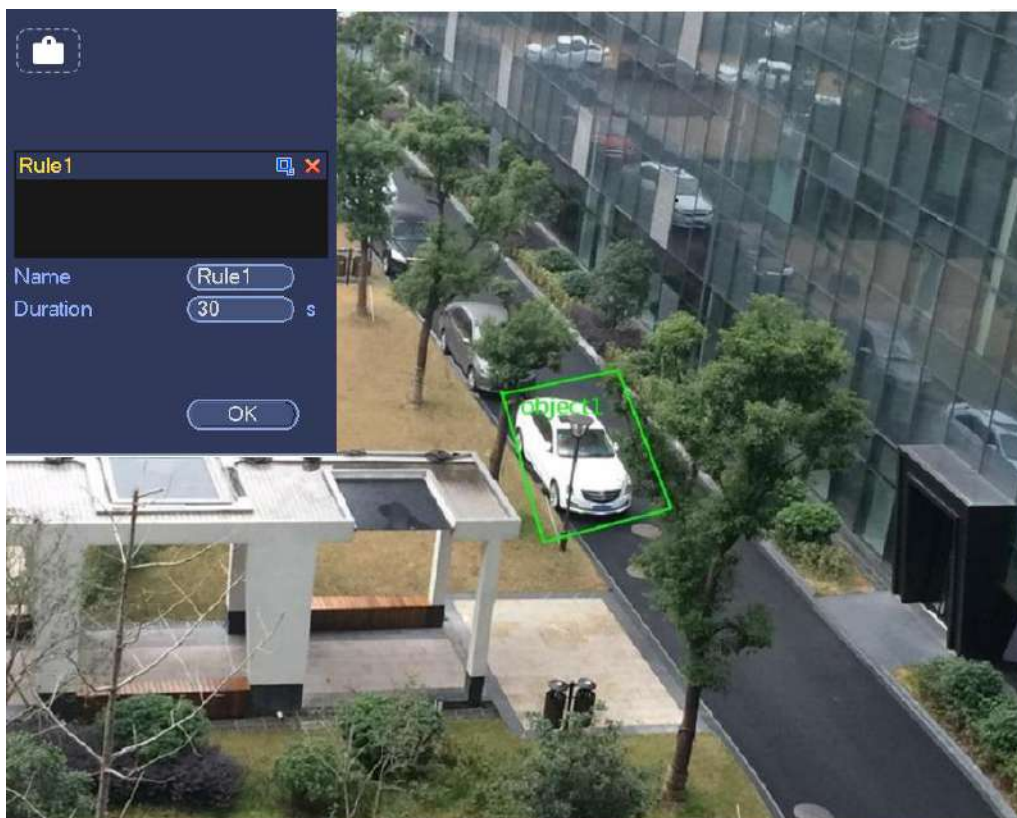



Figure 4-129

- Preset: Select a preset you want to use behavior analytics.
- Name: Input customized rule name.
- Duration: System can generate an alarm once the object is in the zone for the specified period.
- Target filter: Click , you can set filter object size. Each rule can set two sizes (min size/max size). Once the object is smaller than the min size or larger than the max size, there is no alarm. Please make sure the max size is larger than the min size.

Now you can draw a rule. Left click mouse to draw a zone, until you draw a rectangle, you can right click mouse.

Tips

Click  to delete the corresponding rule.

Click , you can refer to the chapter 4.7.3.1 to set other parameters.

Click Apply to complete the setup.

4.7.3.4 Missing Object Detection (Optional)

System generates an alarm when there is missing object in the specified zone.

From main menu->Setting->Event->Behavior analytics, select the type as abandoned object, the object interface is shown as below. See Figure 4-130.

- System supports customized area shape and amount.
- Support duration setup.
- Support objects filter function.



Figure 4-130

Click Draw button  to draw a zone. See Figure 4-131.

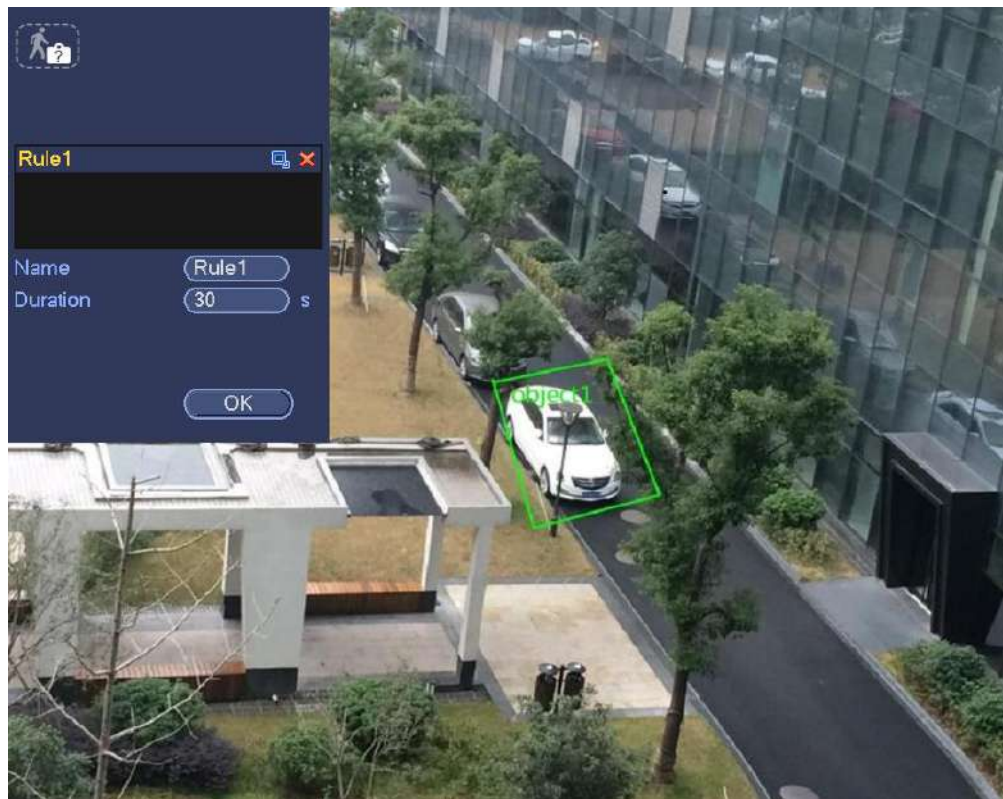



Figure 4-131

- Preset: Select a preset you want to use behavior analytics.
- Name: Input customized rule name.
- Duration: System can generate an alarm once the object in the zone is missing for the specified period.

- Target filter: Click , you can set filter object size. Each rule can set two sizes (min size/max size). Once the object is smaller than the min size or larger than the max size, there is no alarm. Please make sure the max size is larger than the min size.

Now you can draw a rule. Left click mouse to draw a zone, until you draw a rectangle, you can right click mouse.

Tips

Click  to delete the corresponding rule.

Click , you can refer to the chapter 4.7.3.1 to set other parameters.

Click Apply to complete the setup.

4.7.3.5 Loitering Detection (Optional)

System can generate an alarm once the object is staying in the specified zone longer than the threshold. From main menu->Setting->Event->Behavior analytics, select the type as loitering, the object interface is shown as below. See Figure 4-132.

- System supports customized area shape and amount.
- Support duration setup.
- Support objects filter function.



Figure 4-132

Click draw button  to draw the zone. See Figure 4-133.

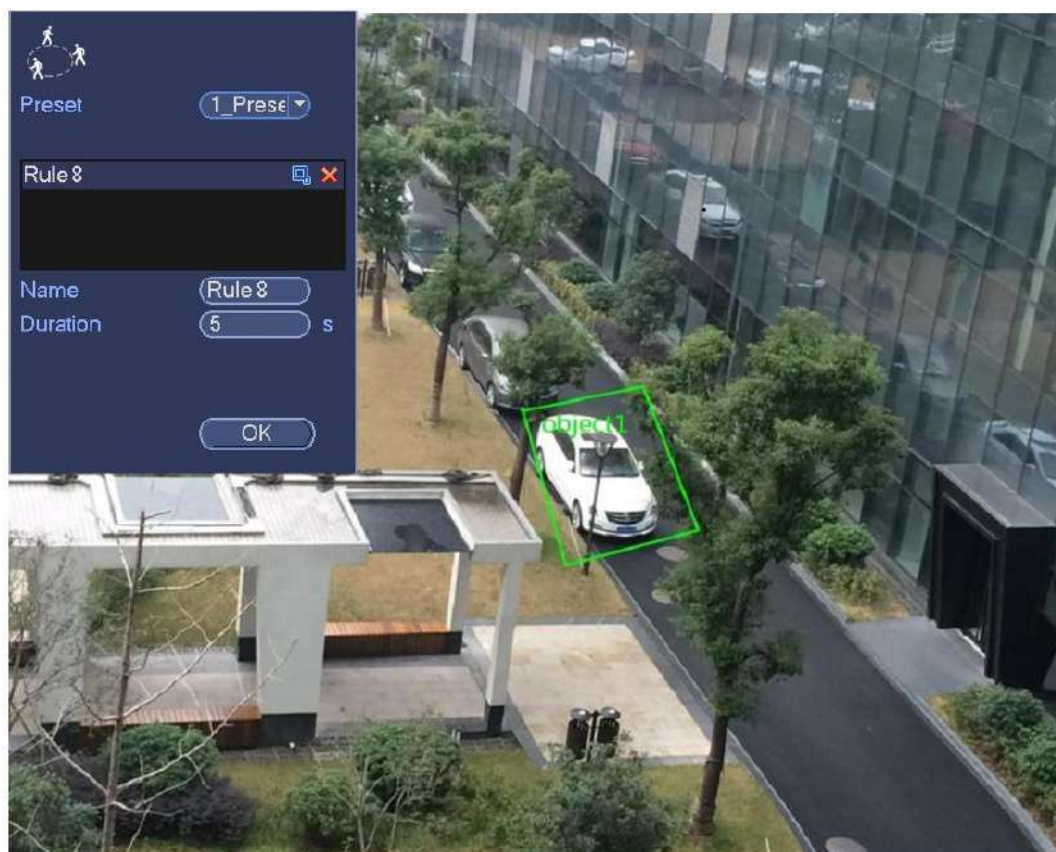



Figure 4-133

- Preset: Select a preset you want to use behavior analytics.
- Name: Input customized rule name.
- Duration: System can generate an alarm once the object is in the zone for the specified period.
- Target filter: Click , you can set filter object size. Each rule can set two sizes (min size/max size). Once the object is smaller than the min size or larger than the max size, there is no alarm. Please make sure the max size is larger than the min size.

Now you can draw a rule. Left click mouse to draw a zone, until you draw a rectangle, you can right click mouse.

Tips

Click  to delete the corresponding rule.

Click , you can refer to the chapter 4.7.3.1 to set other parameters.

Click Apply to complete the setup.

4.7.3.6 Crowd Gathering Detection (Optional)

System can generate an alarm once the people amount gathering in the specified zone is larger than the threshold.

From main menu->Setting->Event->Behavior analytics, select the type as crowd gathering detect, the interface is shown as below. See Figure 4-134.

- Customized zone and amount setup.
- Duration setup.
- Sensitivity setup.
- Min gathering zone setup.



Figure 4-134

Click draw button  to draw the zone. See Figure 4-135.

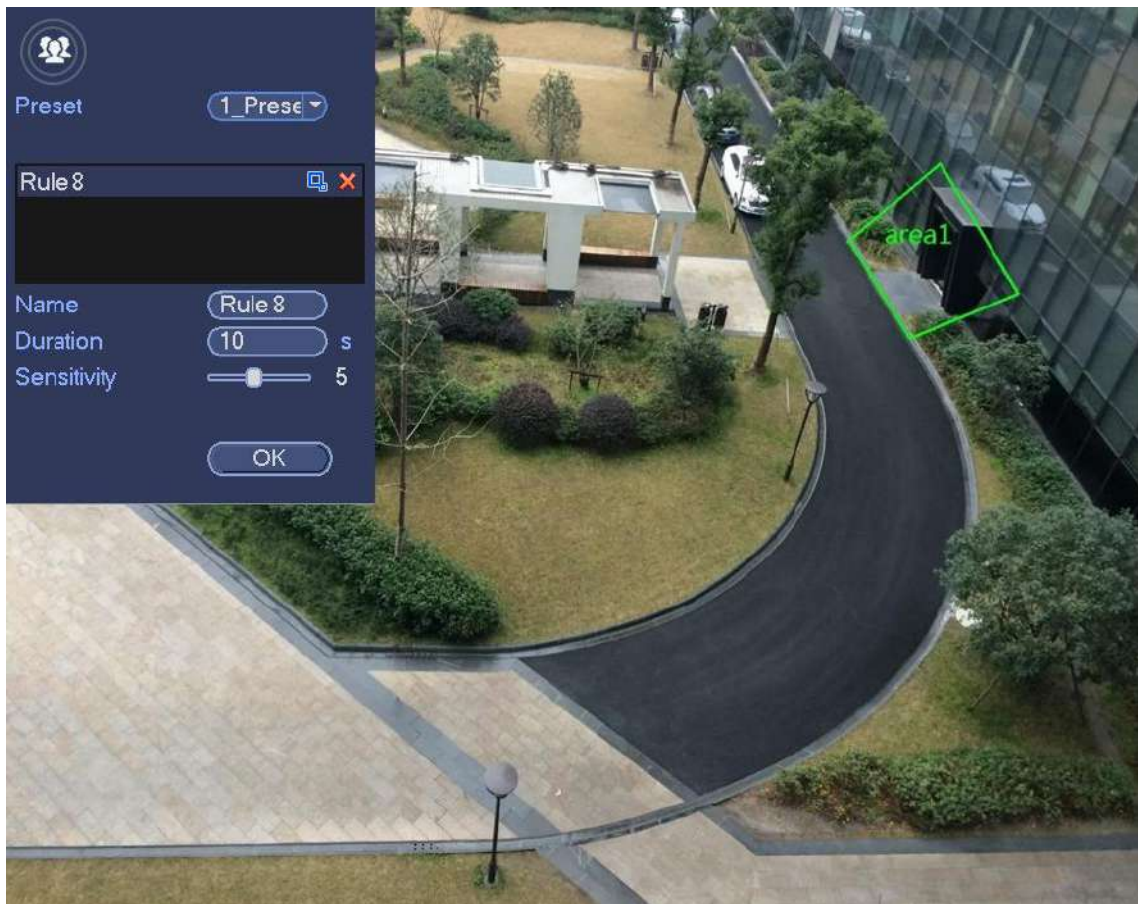



Figure 4-135

- Preset: Select a preset you want to use behavior analytics.
- Name: Input customized rule name.
- Duration: System can generate an alarm once the object is in the zone for the specified period.
- Sensitivity: It is to set alarm sensitivity. The value ranges from 1 to 10. The default setup is 5.
- Target filter: Click , you can set filter object size. Each rule can set two sizes (min size/max size). Once the object is smaller than the min size or larger than the max size, there is no alarm. Please make sure the max size is larger than the min size.

Now you can draw a rule. Left click mouse to draw a zone, until you draw a rectangle, you can right click mouse.

Tips

Click  to delete the corresponding rule.

Click , you can refer to the chapter 4.7.3.1 to set other parameters.

Click Apply to complete the setup.

4.7.3.7 Fast moving (Optional)

It is to detect the fast moving object in the specified zone.

From main menu->Setting->Event->Behavior analytics, select the type as fast moving, the interface is shown as below. See Figure 4-136.



Figure 4-136

Click draw button  to draw the zone. See Figure 4-137.

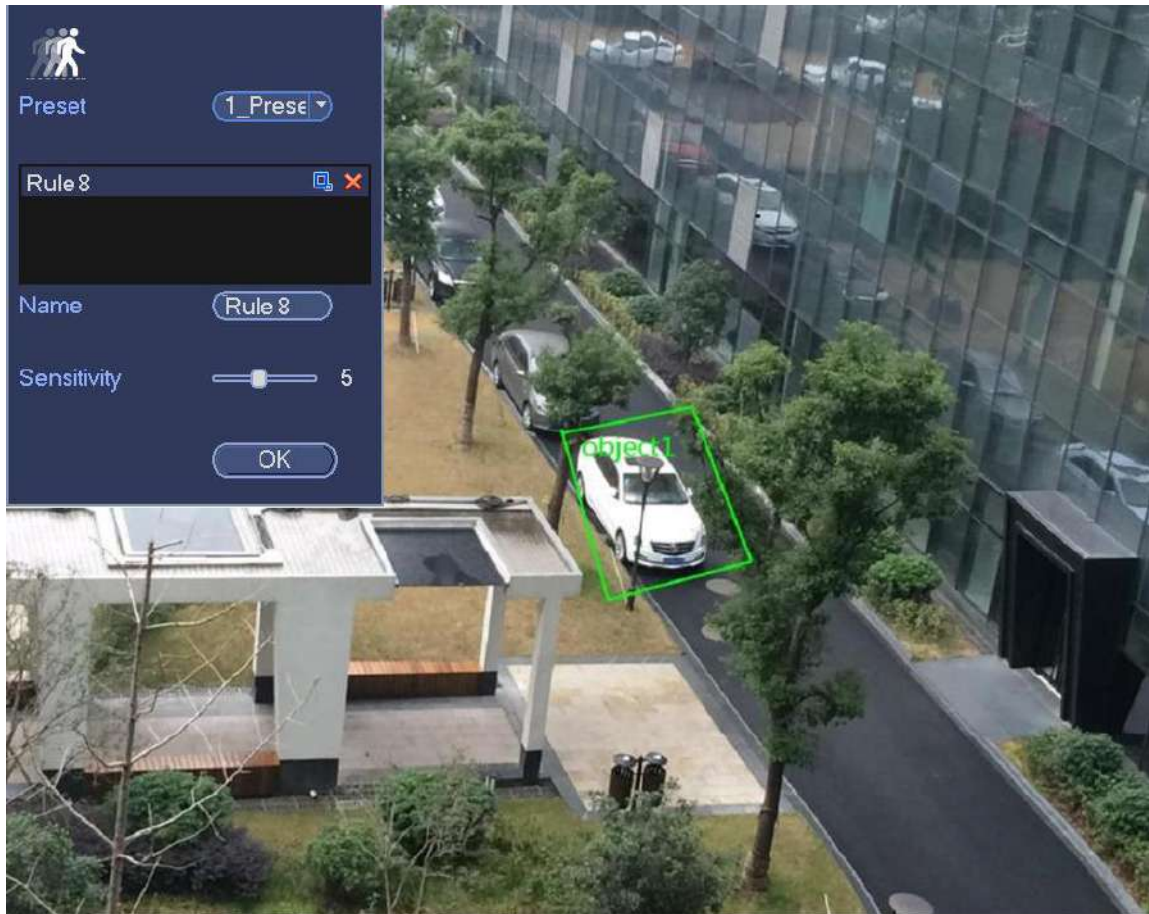



Figure 4-137

- Preset: Select a preset you want to use behavior analytics.
- Name: Input customized rule name.
- Sensitivity: It is to set alarm sensitivity. The value ranges from 1 to 10. The default setup is 5.
- Target filter: Click , you can set filter object size. Each rule can set two sizes (min size/max size). Once the object is smaller than the min size or larger than the max size, there is no alarm. Please make sure the max size is larger than the min size.

Now you can draw a rule. Left click mouse to draw a zone, until you draw a rectangle, you can right click mouse.

Tips

Click  to delete the corresponding rule.

Click , you can refer to the chapter 4.7.3.1 to set other parameters.

Click Apply to complete the setup.

4.7.3.1 Global Setup (Optional)

After set one horizontal gauge and three vertical gauge and the actual distances between each gauge, the system can estimate the network camera internal parameters (internal geometrical features and optical properties) and external parameters (the network camera position and direction on the actual environment), it can confirm the actual distance on the current surveillance environment.

From main menu->Setting->Event->IVS (Behavior analytics), enter the following interface. See Figure



Figure 4-138

Click Global config button, the interface is shown as below. See Figure 4-139.

- Channel: Please select a channel from the dropdown list.
- Preset: Select a preset you want to set the rule. Please note, you need to add a preset first, otherwise, you cannot see the preset dropdown list. If there is no preset, you can draw a rule in current channel.
- Calibration zone:
 - ✧ Click Add zone , you can draw a calibration zone at the left pane of the interface. Select a zone and then click Delete zone button; you can remove the selected zone.
 - ✧ Select gauge type (horizontal/tilt), you can set the corresponding length. You can draw three tilt gauges and one horizontal gauge at the left pane of the interface.
 - Select Width/Height and then click Verify, you can draw a line in the calibration zone, and then you can see its actual length.
 - Refresh preset: Click it to get the latest preset setup.

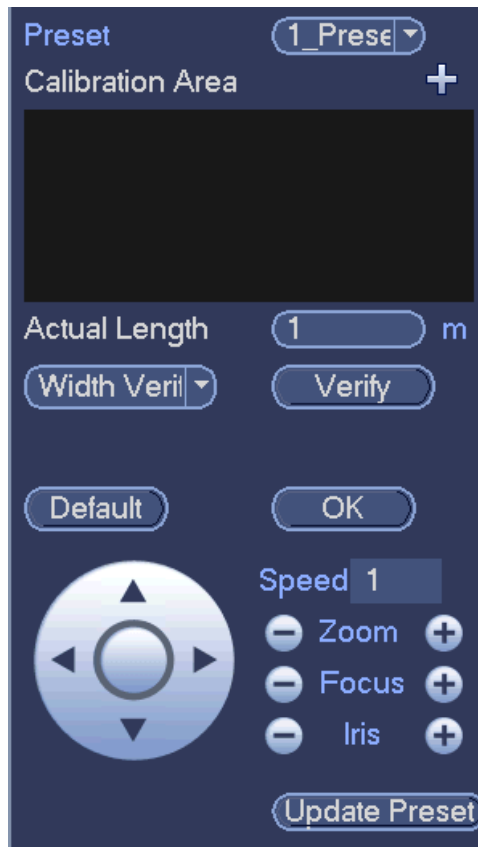

Figure 4-139

4.7.4 Face Detect (Optional)

System processes and analyzes the video from the camera. System can generate an alarm when it detects there is any human face information.

From main menu->Setting->Event->Face detect, the interface is shown as in Figure 4-140.

- Face ROI: Check the box here, system can enhance the human face display pane.



Note

Make sure the connected camera supports human face detect function if you want to use face ROI function.

- Log: Check the box here, system can record face detect log.

You can refer to the chapter 4.7.1.1 Motion detect to set other parameters.



Figure 4-140

4.7.5 People Counting (Optional)

System adopts video image and graphics analysis technology. System can calculate the entry/exit people amount in the specified zone on the video. It can generate an alarm when the amount has exceeded the threshold.

From main menu->Setting->Event->People counting, you can see an interface shown as in Figure 4-141.

- Enable: Check the box to enable people counting function.
- OSD overlay: Check the box here; you can view the people amount on the surveillance video.
- Rule setup: Click Set button, you can set people counting zone, name, and direction (entry/exit).
- Entry No.: It is to set people entry amount. System can generate an alarm once the amount has exceeded the threshold.
- Exit No.: It is to set people exit amount. System can generate an alarm once the amount has exceeded the threshold.
- Remaining No.: It is to set people staying amount in the zone. System can generate an alarm once the amount has exceeded the threshold.

You can refer to the chapter 4.7.1.1 motion detect to set other parameters.

Click OK to complete the setup.



Figure 4-141

After you set the people counting function, from main menu->Info->Event->People counting, you can view people counting statistics report. Please refer to chapter 4.7.1.1 Motion detect for detailed information.

4.7.6 Heat Map

Heat map technology can monitor the active objects distribution status on the specified zone during a period of time, and use the different colors to display on the heat map.

- Step 1 From main menu->Setting->Event->Heat map.
Enter heat map interface. See Figure 4-142.



Figure 4-142

Step 2 Select a channel number and then check the box to enable the function.

Step 3 Click Setup button.

Enter setup interface. See Figure 4-143.

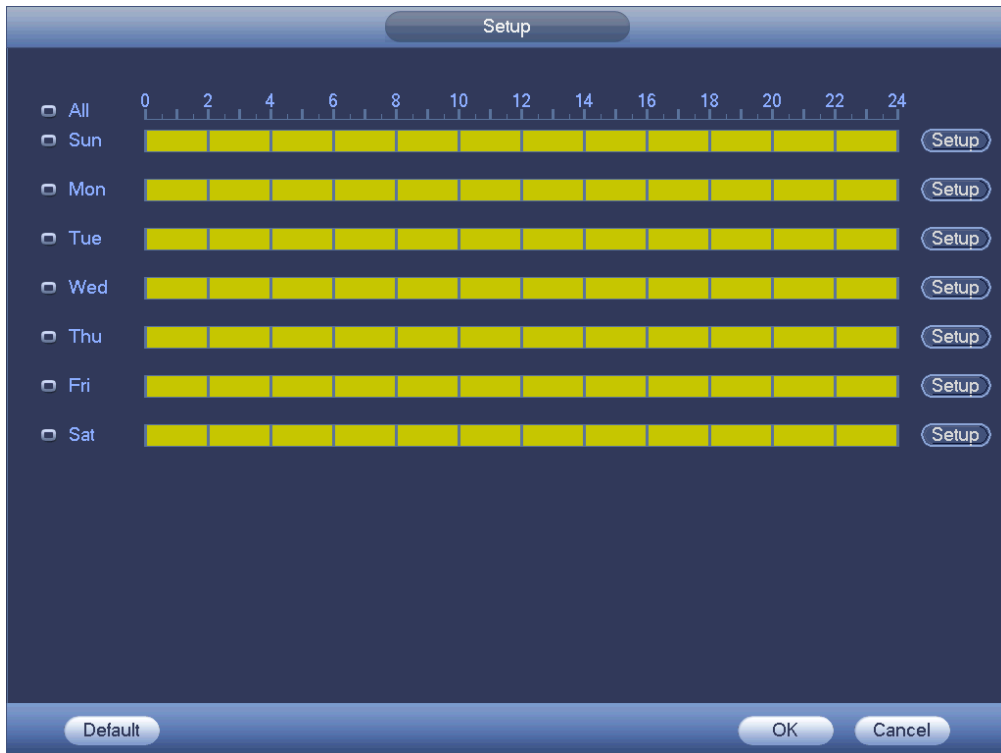

Figure 4-143

Step 4 Set arm/disarm period. Refer to chapter 4.7.1.1 Motion detect for detailed setup information.

Step 5 Click Apply button to complete setup.

 **Note**

After set the heat map parameters, go to main menu->Info->Event->Heat map to view heat map report. Refer to chapter 4.10.2.3.3 for detailed setup information.

4.7.7 Plate Recognition

4.7.7.1 Plate recognition settings

Device can generate an alarm when it detects the corresponding plate information.

Please follow the steps listed below.

Step 1 From main menu->Setting->Event->Plate recognition->Plate recognition.

Enter plate recognition interface. See Figure 4-144.



Figure 4-144

Step 2 Check Enable to enable plate recognition function.

Step 3 Select a channel number and then click the Rule to set the plate recognition name and detection zone.

Step 4 Click Regular, blacklist, whitelist to set.

 **Note**

Before use blacklist alarm or whitelist alarm function, please add the corresponding plate information. Refer to chapter 4.7.7.2 B/W list for detailed information.

- Regular: In this interface, device triggers an alarm when it detects all plate numbers.
- Blacklist: In this interface, device triggers an alarm when it detects plate number in the blacklist.

- **Whitelist:** In this interface, device triggers an alarm when it detects plate number in the whitelist.

4.7.7.2 B/W List

It is to set the blacklist and the whitelist. It includes add, delete, import, export blacklist/whitelist.

After setting the blacklist/whitelist, in the plate snapshot list on the preview interface, the blacklist plate number is red, the whitelist plate number is green, the regular plate number is white.

Add blacklist/whitelist

Step 1 From main menu->Setting->Event->Plate recognition->B/W list.

Enter B/W list interface. See Figure 4-145.

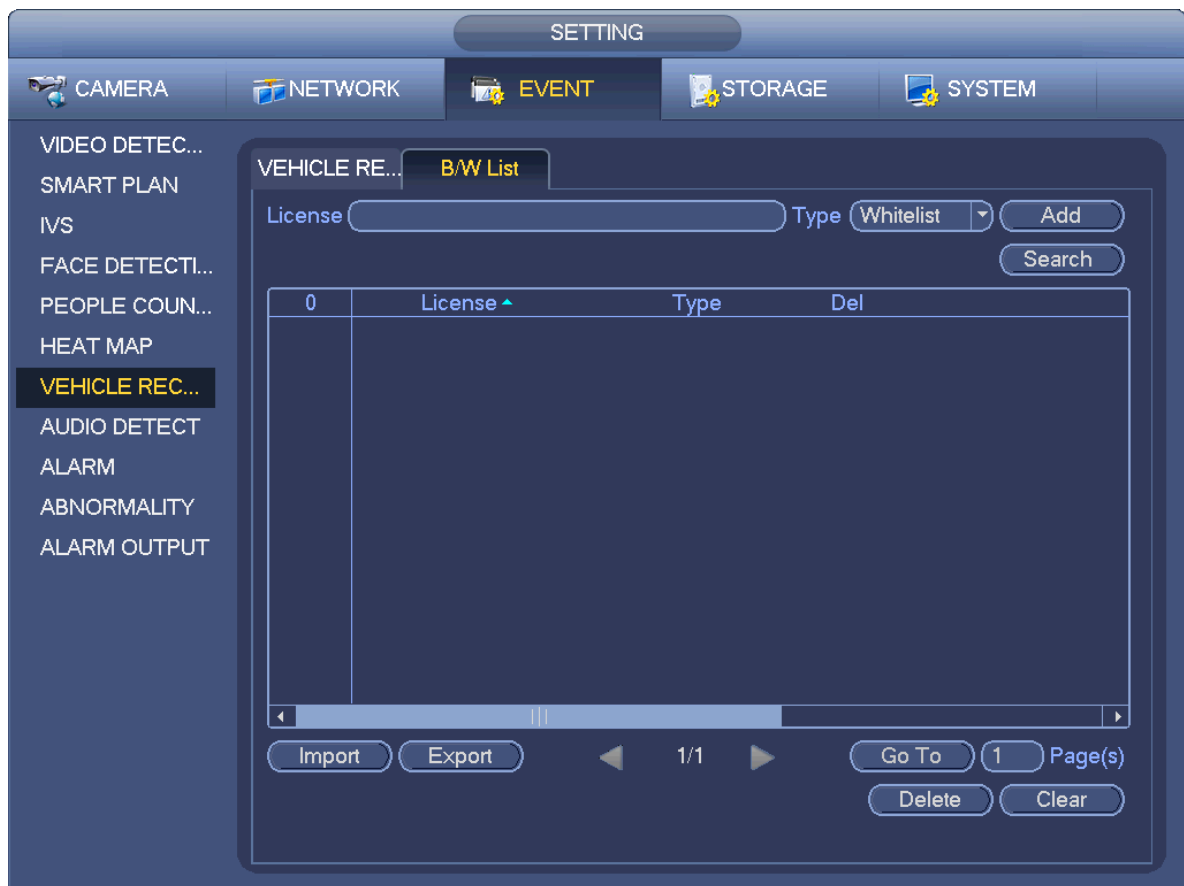



Figure 4-145

Step 2 Set plate number and then select type as blacklist or whitelist.

Step 3 Click Add button.

Delete blacklist/whitelist

Set type as blacklist, whitelist or all, click Search button, device displays the corresponding information.

- Check the box before the plate number and then click Delete to delete a plate number. Or click  of the corresponding plate number to delete.
- Click Clear to delete all plate information on the blacklist/whitelist.

Import/export blacklist/whitelist

Device support blacklist/whitelist import/export function via the USB device. The import file supports .csv and xlsx. The export file is .csv.

- Import blacklist/whitelist: Set the type as blacklist or whitelist and then click Import button. Select the corresponding file and then click Open button to import.
- Export blacklist/whitelist: Set the type as blacklist or whitelist and then click Export button. Select the file save path and then click Save.

Note

When export the blacklist, the file name is “TrafficBlackList_20160321114429_xx.csv”. When export whitelist, the file name is “TrafficRedList_20160321114429_xx.csv”. The “20160321114429” is file import/export date.

4.7.8 Audio Detect (Optional)

System can generate an alarm once it detect the audio is not clear, the tone color has changed or the is abnormal or audio volume changes.

From main menu->Setting->Event->Audio detect, you can see an interface shown as in Figure 4-146.

- Input abnormal: Check the box here, system can generate an alarm once the audio input is abnormal.
- Intensity change: Check the box here, system can generate an alarm once the audio volume becomes strong.
- Sensitivity: It refers to the audio recognition sensitivity. The higher the value is, the higher the sensitivity is.
- Threshold: It is to set intensity change threshold. The smaller the value is, the higher the sensitivity is.
- Log: Check the box here, system can record audio detect alarm log.

Refer to the chapter 4.7.1.1 Motion Detect to set other parameters.

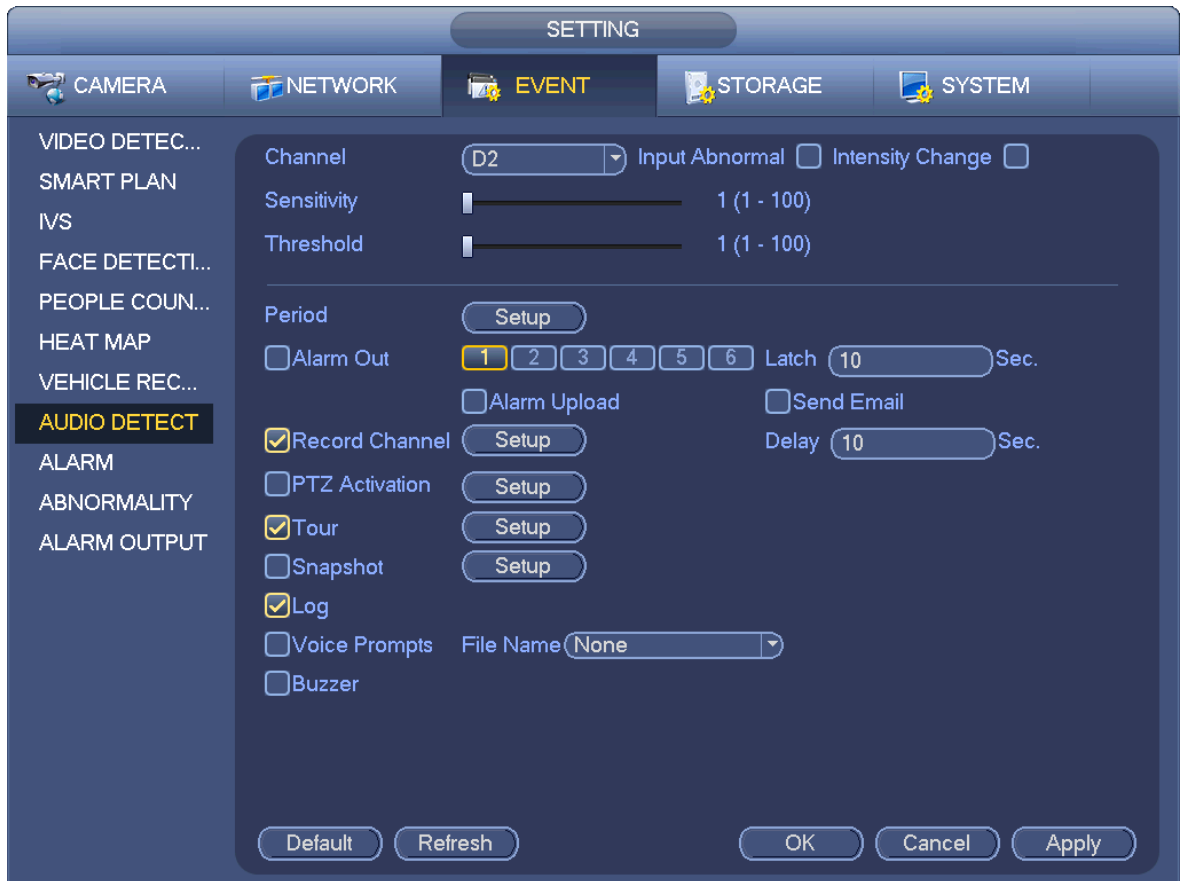

Figure 4-146

4.7.9 Alarm Settings

In the main menu, from Setting->Event->Alarm, you can see alarm setup interface.

- Alarm in: Here is for you to select channel number.

In the main menu, from Setting->Event->Alarm, you can see alarm setup interface. See Figure 4-147.

There are four alarm types. See Figure 4-147 to Figure 4-150.

- ✧ Local alarm: After connect the alarm device to the NVR alarm input port, system can trigger the corresponding alarm operations when there is alarm signal from the alarm input port to the NVR.
- ✧ Network alarm: NVR trigger corresponding alarm operations when it receives the alarm signal via the network transmission.
- ✧ IPC external alarm: When the network camera connected peripheral device has triggered an alarm, it can upload the alarm signal to the NVR via the network transmission. The system can trigger the corresponding alarm operations.
- ✧ IPC offline alarm: When the network connection between the NVR and the network camera is off, the system can trigger the corresponding alarm operations.
- Enable: Please you need to highlight this button to enable current function.
- Type: normal open or normal close.
- Period: Click set button, you can see an interface is shown as in Figure 4-152. There are two ways for you to set periods. There are max 6 periods in one day. There are four record types: regular, motion detection (MD), Alarm, MD & alarm.

✧ In Figure 4-152, Select icon  of several dates, all checked items can be edited together.

Now the icon is shown as . Click  to delete a record type from one period.

✧ In Figure 4-152. Click button  after one date or a holiday, you can see an interface shown as in Figure 4-153. There are four record types: regular, motion detection (MD), Alarm, MD & alarm.

- PTZ activation: When an alarm occurred, system can activate the PTZ operation. The PTZ activation lasts an anti-dither period. See Figure 4-151.
- Anti-dither: Here you can set anti-dither time. The value ranges from 5 to 600s. The anti-dither time refers to the alarm signal lasts time. It can be seen as the alarm signal activation stays such as the buzzer, tour, PTZ activation, snapshot, channel record. The stay time here does not include the latch time. During the alarm process, the alarm signal can begin an anti-dither time if system detects the local alarm again. The screen prompt, alarm upload, email and etc will not be activated. For example, if you set the anti-dither time as 10 second, you can see the each activation may last 10s if the local alarm is activated. During the process, if system detects another local alarm signal at the fifth second, the buzzer, tour, PTZ activation, snapshot, record channel will begin another 10s while the screen prompt, alarm upload, email will not be activated again. After 10s, if system detects another alarm signal, it can generate an alarm since the anti-dither time is out.
- Alarm output: The number here is the device alarm output port. You can select the corresponding ports(s) so that system can activate the corresponding alarm device(s) when an alarm occurred.
- Latch: When the anti-dither time ended, the channel alarm you select in the alarm output may last the specified period. The value ranges from 1 to 300 seconds. This function is not for other alarm activation operations. The latch is still valid even you disable the alarm event function directly.
- Show message: System can pop up a message to alarm you in the local host screen if you enabled this function.
- Alarm upload: System can upload the alarm signal to the network (including alarm center and the WEB) if you enabled current function. System only uploads the alarm channel status. You can go to the WEB and then go to the Alarm interface to set alarm event and alarm operation. Please go to the Network interface to set alarm center information.
- Send email: System can send out the alarm signal via the email to alert you when alarm occurs. Once you enable the snap function, system can also send out an image as the attachment. Please go to the Main Menu->Setting ->Network->Email interface to set.
- Record channel: you can select proper channel to record alarm video (Multiple choices).
 - ✧ You need to set alarm record mode as Schedule in Record interface (Main Menu->Advanced->Record). Please note the manual record has the highest priority. System record all the time no matter there is an alarm or not if you select Manual mode.
 - ✧ Now you can go to the Schedule interface (Main Menu->Setting->Schedule) to set the record type, corresponding channel number, week and date. You can select the record type:Regular/MD/Alarm/MD&Alarm. Please note, you cannot select the MD&Alarm and MD(or Alarm) at the same time.
 - ✧ Now you can go to the Encode interface to select the alarm record and set the encode parameter (Main Menu->Setting->Encode).
 - ✧ Finally, you can set the alarm input as the local alarm and then select the record channel. The select channel begins alarm record when an alarm occurred. Please note system begins the

alarm record instead of the MD record if the local alarm and MD event occurred at the same time.

- **Tour:** Here you can enable tour function when an alarm occurs. System supports 1/8-window tour. Please go to chapter 4.3.6.2 Display for tour interval setup. Please note the tour setup here has higher priority than the tour setup you set in the Display interface. Once there two tours are both enabled, system can enable the alarm tour as you set here when an alarm occurred. If there is no alarm, system implements the tour setup in the Display interface.
- **Snapshot:** You can enable this function to snapshot image when an alarm occurs.
- **Buzzer:** Highlight the icon to enable this function. The buzzer beeps when an alarm occurs.



Figure 4-147

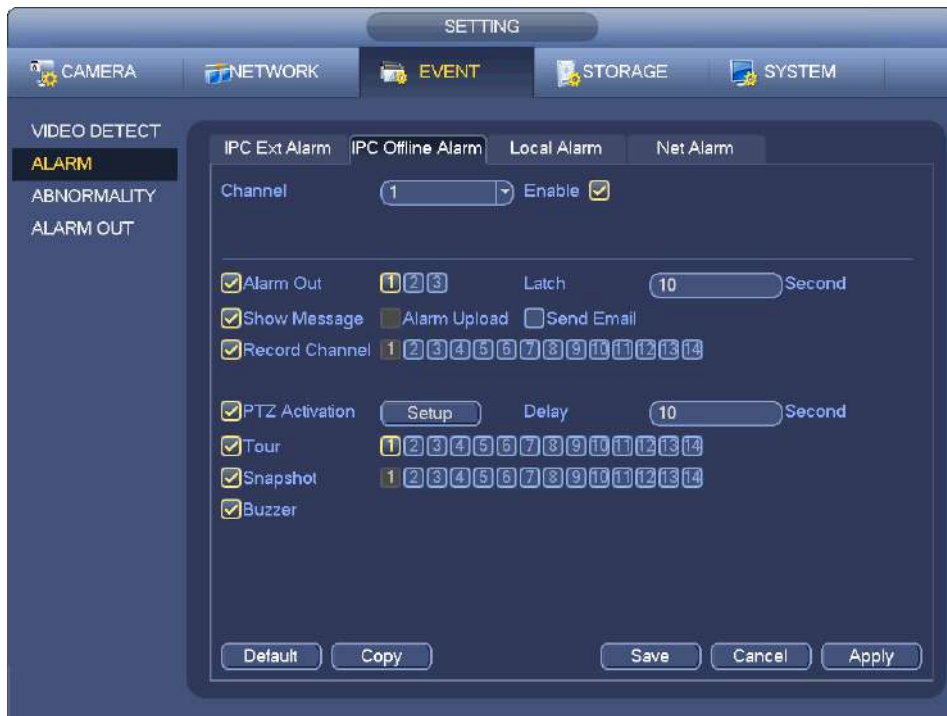

Figure 4-148



Figure 4-149



Figure 4-150



Figure 4-151



Figure 4-152



Figure 4-153

Please highlight icon  to select the corresponding function. After setting all the setups please click save button.

4.7.10 Abnormality

There are three types: Disk/Network/User.

- ✧ Disk: Disk error, no disk, no space. See Figure 4-154.
- ✧ Network: Disconnection, IP conflict, MAC conflict. See Figure 4-155.
- ✧ User: Illegal login. Figure 4-156.

- Alarm output: Please select alarm activation output port (multiple choices).
- Less than: System can alarm you when the HDD space is less than the threshold you set here (For HDD no space type only).
- Attempts: In user interface, select illegal login from the dropdown list. Here you can set login attempts. The value ranges from 1 to 10.
- Lock time: In user interface, select illegal login from the dropdown list. Here you can set account lock time. The value ranges from 1 to 30 minutes.
- Latch: Here you can set corresponding delaying time. The value ranges from 1s-300s. System automatically delays specified seconds in turning off alarm and activated output after external alarm cancelled.
- Show message: system can pop up the message in the local screen to alert you when alarm occurs.
- Alarm upload: System can upload the alarm signal to the network (including alarm center) if you enabled current function. For disconnection event, IP conflict event and MAC conflict event, this function is null.
- Send email: System can send out email to alert you when alarm occurs.
- Buzzer: Highlight the icon to enable this function. The buzzer beeps when an alarm occurs.

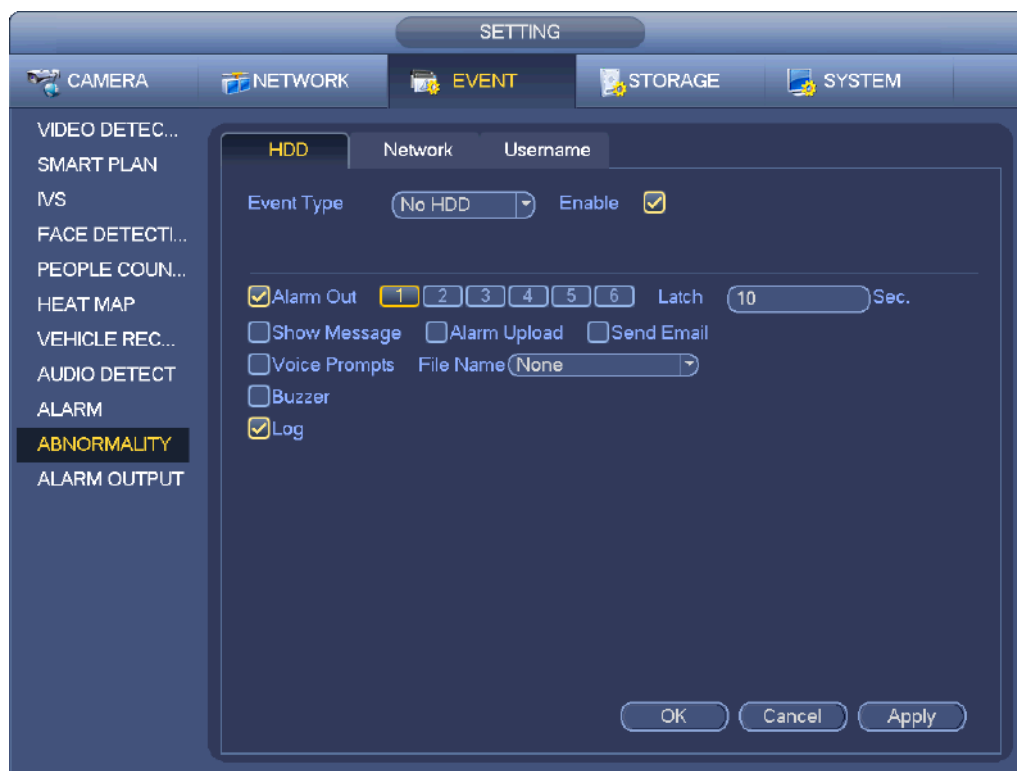

Figure 4-154



Figure 4-155



Figure 4-156

4.7.11 Alarm output

From Main menu->Setting->Event->Alarm output, you can see an interface shown as in Figure 4-157.

Here is for you to set proper alarm output (Auto/manual/stop). Connect the alarm device to the system alarm output port, and set the mode as auto, system can trigger the corresponding operations when an alarm occurs.

- Auto: Once an alarm event occurs, system can generate an alarm.
- Manual: Alarm device is always on the alarming mode.
- Stop: Disable alarm output function.

Click OK button of the alarm reset, you can clear all alarm output status.



Figure 4-157

Please highlight icon  to select the corresponding alarm output. After all the setups please click OK button.

4.7.12 POS

Connect the device with the POS, the device can receive the POS information and overlay corresponding info on the video.

Note

- For the local-end, this function supports 1/4-window display and 1-window playback.
- This function is for the cashier of the supermarket and etc. The device can get the information from the POS and then overlay the txt information on the video.

Step 1 From main menu->Setting->System->POS, the interface is shown as below. See Figure 4-158.

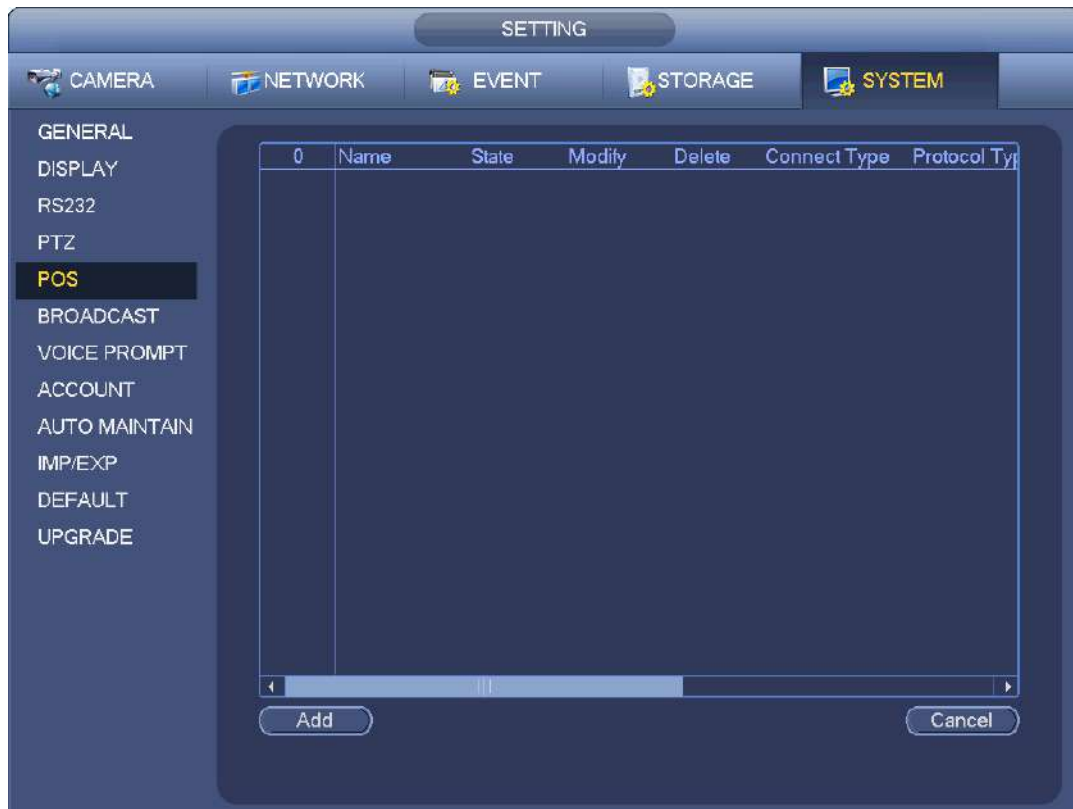



Figure 4-158

Step 2 Click Add button, the interface is shown as below. See Figure 4-159.

Set parameters.

- Enable: Check the box to enable POS function.
- Name: Set POS name.

1. Click 
2. Input POS name on the pop-up dialogue box.
3. Click OK button.

 **Note**

The POS name shall be unique.

System max supports 64 English letters.

- Event: Set POS arm/disarm period, record channel and etc. Click Setup to go to the interface. For detailed information, please refer to chapter 4.7.1.1 motion detect.
- Privacy: After enable this function, once the overlay information contain the privacy character, it displays as *. For example, the privacy character is 12,56,89, the local preview and WEB surveillance information is shown as **34**7** if the overlay information is 123456789. For detailed information, please refer to chapter 4.7.12.1 privacy setup.
- Protocol type: The default setup is POS.
- Connection type: It is to set and NVR connection mode. It includes UDP,TCP,RS232,RS485. After set the connection type, please click the Setup button to set the corresponding parameters. For detailed information, please refer to chapter 4.7.12.2 connection type.
- Convert: It is to set font type.
- Overlay: It is to set overlay mode. It includes turn and roll.

- ◇ Turn: Once the overlay information has reached 8 lines, NVR turn to the next page.
- ◇ Roll: Once the overlay information has reached 8 lines, NVR displays the next new line and delete the oldest line.
- Network overtime: Once there is no POS data for the specified period, NVR automatically deletes POS information after specified period.
- Font size: The overlay font size.
- Color: The overlay font color.
- POS Info: Check the box to overlay information on the local preview window.
- Advanced: Click  to enter advanced settings interface.
- Transaction start/transaction end: It is to set transaction start and end character. The overlay information only displays the character after the start string and before the end string. For example, the start character is 12 and the end character is 90, NVR displays 34567 on local preview and Web preview interface if the sending out information is 123456789.
- Line delimiter: After set the line delimiter, the overlay information after the delimiter is displayed in the new line. For example, the line delimiter is 45 and the overlay information is 123456789, NVR displays 123 in the first line and displays 6789 in the second line.
- Hex: Check the Hex to switch ASCII code.
- Case insensitive: Check the box to enable case insensitive function.
 - ◇ When this function is enabled, set the start character as “aa”, NVR cannot distinguish the upper and lower case when sending out information “11aA23456”. The NVR overlays information is “23456” on local surveillance and Web preview.
 - ◇ When this function is disabled, set the start character as “aa”, NVR can distinguish the upper and lower case when sending out information “11aA23456”. The NVR does not overlay information local surveillance and Web preview.

4.7.12.1 Privacy Setup

Step 1 Click Setup

Enter Setup interface. See Figure 4-159,



Figure 4-159

Step 2 Set privacy information.

Step 3 Click OK button.

4.7.12.2 Connection type

- **Connection type is UDP or TCP.**

Step 1 Click Setup.

Enter Setup interface. See Figure 4-160.



Figure 4-160

Step 2 Source IP and port refers to POS IP address and port.

 **Note**

Destination IP and port refers to NVR IP address and port. System can auto get and display.

Step 3 Click OK to complete setup.

- **Connection mode is RS232 or RS485.**

Step 1 Click Setup.

Enter Setup interface. See Figure 4-161.



Figure 4-161

Step 2 Set address, baud rate, data bit, stop bit and parity.

 **Note**

Make sure the parameters here are the same with the POS setup.

Step 3 Click OK to complete setup.

4.8 Network

4.8.1 Network Settings

4.8.1.1 TCP/IP

The single network adapter interface is shown as in Figure 4-162 and the dual network adapters interface is shown as in Figure 4-163.

- Network Mode : Includes multiple access, fault tolerance, and load balancing
 - ◇ Multiple-address mode: eth0 and eth1 operate separately. You can use the services such as HTTP, RTP service via eth0 or the eth1. Usually you need to set one default card (default setup is eth0) to request the auto network service form the device-end such as DHCP, email, FTP and etc. In multiple-address mode, system network status is shown as offline once one card is offline.

- ✧ Network fault-tolerance: In this mode, device uses bond0 to communicate with the external devices. You can focus on one host IP address. At the same time, you need to set one master card. Usually there is only one running card (master card). System can enable alternate card when the master card is malfunction. The system is shown as offline once these two cards are both offline. Please note these two cards shall be in the same LAN.
- ✧ Load balance: In this mode, device uses bond0 to communicate with the external device. The eth0 and eth1 are both working now and bearing the network load. Their network load are general the same. The system is shown as offline once these two cards are both offline. Please note these two cards shall be in the same LAN.
- Default Network Card: Please select eth0/eth1/bond0(optional) after enable multiple-access function
- Main Network Card: Please select eth0/eth1 (optional).after enable multiple access function.

Note: The dual-Ethernet port series support the above three configurations and supports functions as multiple-access, fault-tolerance and load balancing.

- IP Version: There are two options: IPv4 and IPv6. Right now, system supports these two IP address format and you can access via them.
- MAC address: The host in the LAN can get a unique MAC address. It is for you to access in the LAN. It is read-only.
- IP address: Here you can use up/down button (▲▼) or input the corresponding number to input IP address. Then you can set the corresponding subnet mask the default gateway.
- Default gateway: Here you can input the default gateway. Please note system needs to check the validity of all IPv6 addresses. The IP address and the default gateway shall be in the same IP section. That is to say, the specified length of the subnet prefix shall have the same string.
- DHCP: It is to auto search IP. When enable DHCP function, you cannot modify IP/Subnet mask /Gateway. These values are from DHCP function. If you have not enabled DHCP function, IP/Subnet mask/Gateway display as zero. You need to disable DHCP function to view current IP information. Besides, when PPPoE is operating, you cannot modify IP/Subnet mask /Gateway.
- MTU: It is to set MTU value of the network adapter. The value ranges from 1280-7200 bytes. The default setup is 1500 bytes. Please note MTU modification may result in network adapter reboot and network becomes off. That is to say, MTU modification can affect current network service. System may pop up dialog box for you to confirm setup when you want to change MTU setup. Click OK button to confirm current reboot, or you can click Cancel button to terminate current modification. Before the modification, you can check the MTU of the gateway; the MTU of the NVR shall be the same as or is lower than the MTU of the gateway. In this way, you can reduce packets and enhance network transmission efficiency.

The following MTU value is for reference only.

- ✧ 1500: Ethernet information packet max value and it is also the default value. It is the typical setup when there is no PPPoE or VPN. It is the default setup of some router, switch or the network adapter.
- ✧ 1492: Recommend value for PPPoE.
- ✧ 1468: Recommend value for DHCP.
- Preferred DNS server: DNS server IP address.
- Alternate DNS server: DNS server alternate address.
- Transfer mode: Here you can select the priority between fluency/video qualities.
- LAN download: System can process the downloaded data first if you enable this function. The download speed is 1.5X or 2.0X of the normal speed.

- LAN download: System can process the downloaded data first if you enable this function. The download speed is 1.5X or 2.0X of the normal speed.

After completing all the setups please click save button, system goes back to the previous menu.



Figure 4-162



Figure 4-163

4.8.1.2 Connection

The connection setup interface is shown as in Figure 4-164.

- Max connection: The max client login amount (such as WEB, platform, cellphone and etc). The value ranges from 1 to 128(default).
- TCP port: Default value is 37777.
- UDP port: Default value is 37778.
- HTTP port: Default value is 80.
- HTTPS port: Default value is 443.
- RTSP port: Default value is 554.

Important: System needs to reboot after you changed and saved any setup of the above four ports. Please make sure the port values here do not conflict.



Figure 4-164

4.8.1.3 WIFI AP

Note

This function is for some series product only.

4.8.1.3.1 WIFI AP

The WIFI AP interface is shown as below. See Figure 4-165. Here you can set WIFI hotspot, so that the network camera can use the hotspot to connect to the network.

- 2.4GHz/5GHz: Please check the box to enable the function.
- SSID: It is to set SSID name. You can use this name to search the device.
- Password: It is to set SSID password. You can use this password to connect to the network.
- Security: Select authentication mode from the dropdown list.
- Channel: Please select a channel from the dropdown list. The default setup is auto.
- Mode: There three options: high/middle/low. Please select from the dropdown list.



Figure 4-165

4.8.1.3.2 Advanced

Click Advanced, you can see an interface shown as below. See Figure 4-166.

- IPv4 address: Input WIFI AP IP address.
- IPv4 net mask: Input WIFI AP network mask.
- IPv4 gateway: Input WIFI AP gateway.
- Start IP/End IP: Input start IP and end IP of the network cameras. The NVR can allocate the IP addresses in the range you specified here.
- Upgrade: Click it to upgrade WIFI AP module.



Figure 4-166

4.8.1.4 WIFI

The WIFI interface is shown as below. See Figure 4-167.

- Enable: Check the box here to enable WIFI function.
- Refresh: You can click it to search the hotspot list again. It can automatically add the information such as the password if you have set it before.
- Disconnect: Here you can click it to turn off the connection.
- Connect: Here you can click it to connect to the hotspot. System needs to turn off current connection and then connect to a new hotspot if there is connection of you selected one.

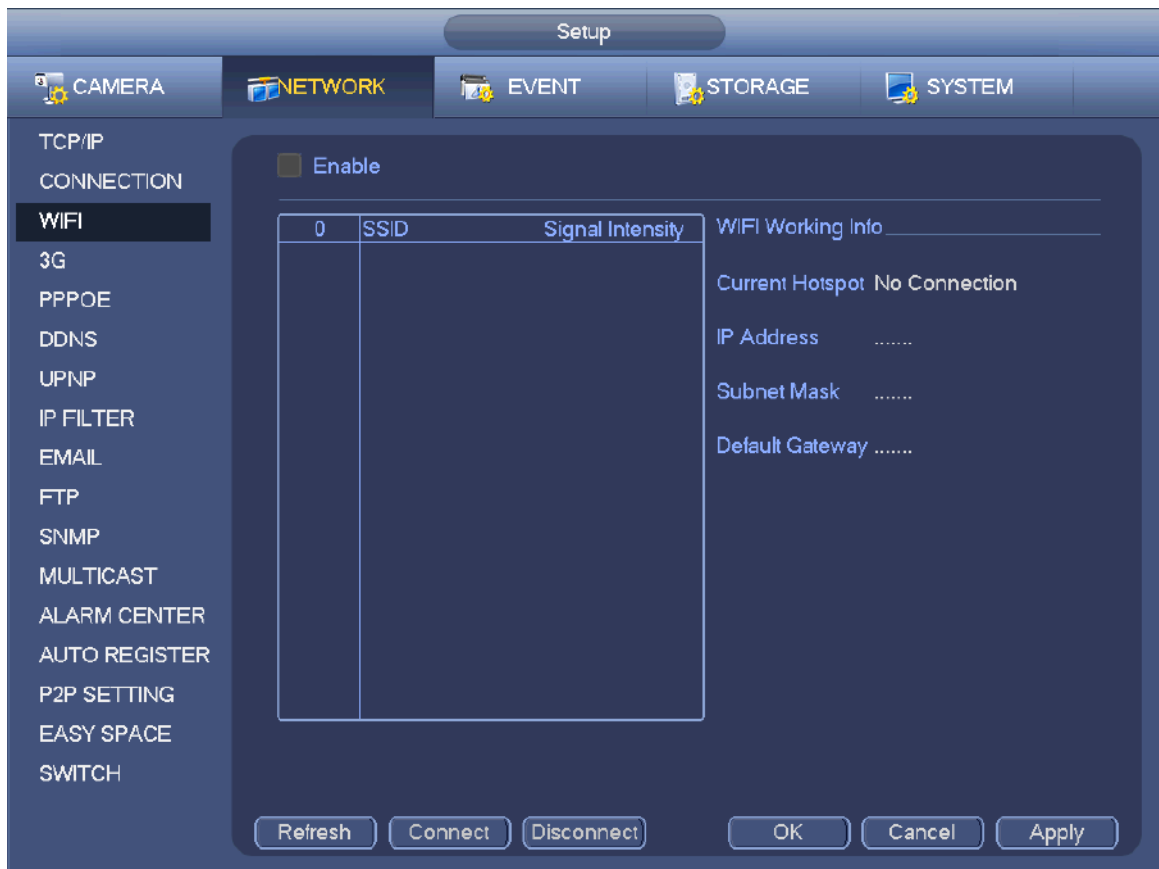

Figure 4-167

- WIFI working status: Here you can view current connection status.

Please note:

- After successful connection, you can see WIFI connection icon at the top right corner of the preview interface.
- When the hotspot verification type is WEP, system displays as AUTO since the device cannot detect its encryption type.
- System does not support verification type WPA and WPA2. The display may become abnormal for the verification type and encryption type.

After device successfully connected to the WIFI, you can view the hotspot name, IP address, subnet mask, default gateway and etc. Right now system support TOTOLINK_N2200UP module.

4.8.1.5 3G

3G setup interface is shown as below. See Figure 4-168.

Please refer to the following contents for the parameter information.

- Pane 1: Display 3G signal intensity after you enabled 3G function.
- Pane 2: Display 3G module configuration information after you enabled 3G function.
- Pane 3: Display 3G module status information after you enabled 3G function.

It is to display current wireless network signal intensity such as EVDO, CDMA1x, WCDMA, WCDMA, EDGE and etc.

- 3G module: It is to display current wireless network adapter name.
- 3G Enable/Disable: Check the box here to enable 3G module.
- Network type: There are various network types for different 3G network modules. You can select according to your requirements.

- APN: It is the wireless connection server. It is to set you access the wireless network via which method.
- AUTH: It is the authentication mode. It supports PAP/CHAP.
- Dial number: Please input 3G network dialup number you got from your ISP.
- User name: It is the user name for you to login the 3G network.
- Password: It is the password for you to login the 3G network.
- Pulse interval: You can set dialup duration. Once you disable the extra stream, the connection time begins. For example, if you input 5 seconds here, then 3G network connection period is 5 seconds. The device automatically disconnect when time is up. If there is no extra stream, 3G network connection is valid all the time. **If the alive time is 0, then the 3G network connection is valid all the time.**
- Dial: Here you can enable or disable 3G network connection/disconnection manually.
- 3G wireless network: Here is to display wireless network status, SIM card status, dial status. If the 3G connection is OK, then you can see the device IP address the wireless network automatically allocates.

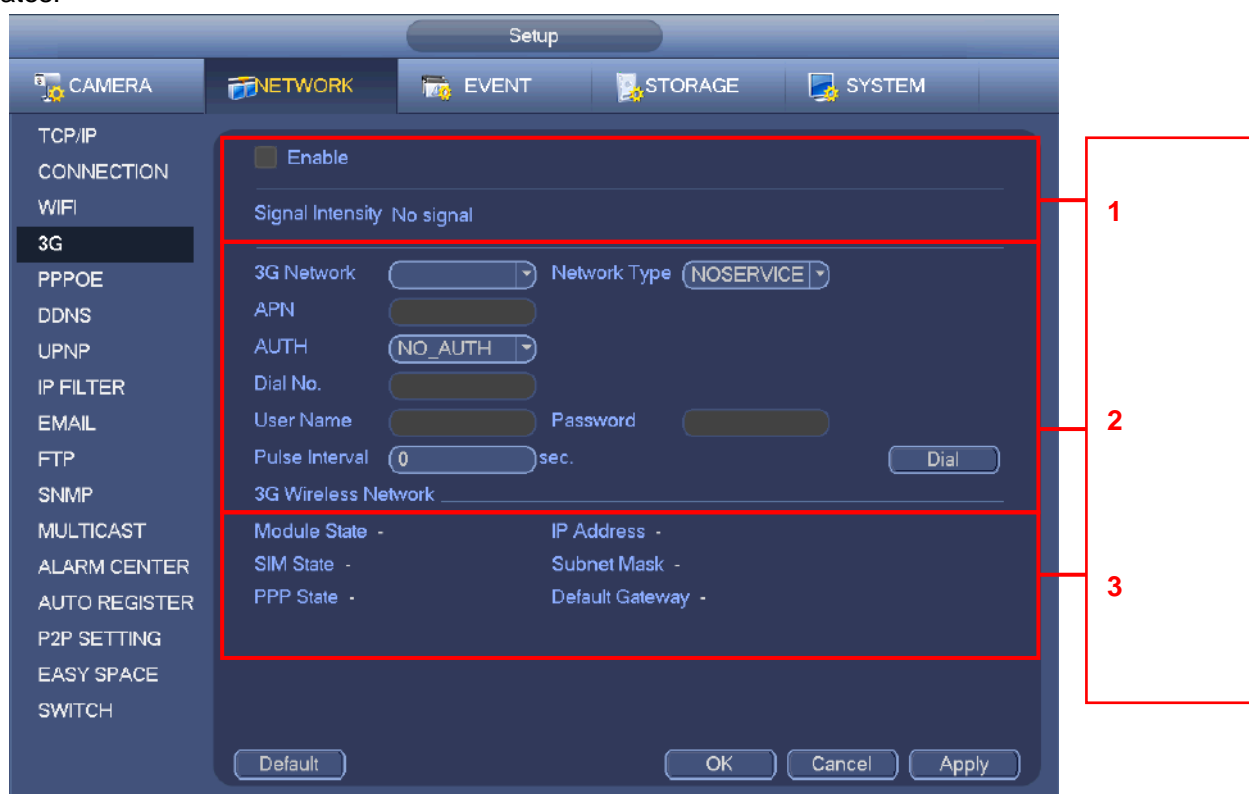

Figure 4-168

4.8.1.6 PPPoE

PPPoE interface is shown as in Figure 4-169.

Input “PPPoE name” and “PPPoE password” you get from your ISP (Internet service provider).

Click save button, you need to restart to activate your configuration.

After rebooting, NVR will connect to internet automatically. The IP in the PPPoE is the NVR dynamic value. You can access this IP to visit the unit.

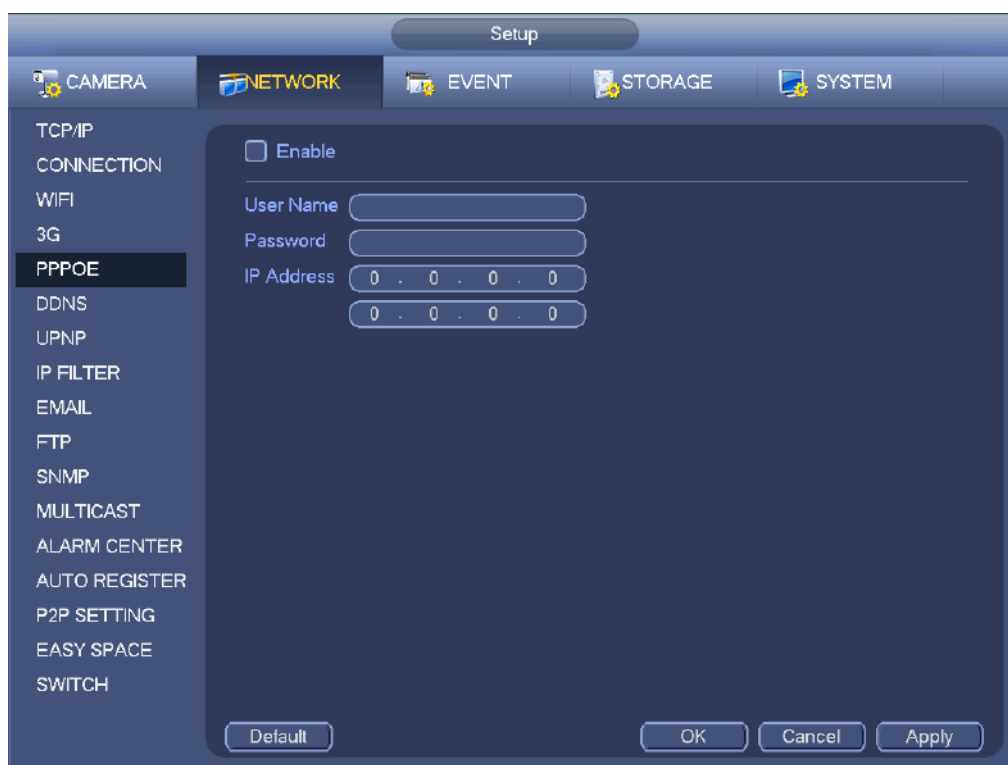

Figure 4-169

4.8.1.7 DDNS

DDNS(Dynamic Domain Name Server) is to dynamically refresh the DNS domain name and IP address if the device IP address has changed frequently. The user can use the domain to access the device.

Preparation

Before the operation, make sure the device supports DNS type and go to the DDNS service provider website to register the domain name via the PC.



Note

After you successfully registered and logged in the DDNS website, you can view all connected device information of current login user.

DDNS setup interface is shown as in Figure 4-170.

- Type/address:
 - ✧ Dahua DDNS is www.dahuaddns.com.
 - ✧ Dyndns DDNS is members.dyndns.org.
 - ✧ NO-IP DDNS is dynupdate.no-ip.com.
 - ✧ CN99 DDNS is members.3322.org.
- Domain: The domain name registered on the DDNS service provider website.
- User name/password: Input the user name and password got from the DDNS service provider. Make sure you have logged in the DDNS service provider website to register an account (user name and password).
- Interval: After DDNS boots up, it sends out refresh query regularly. The unit is minute.

Click Apply or Save to complete setup. Open a browser and input domain name, click Enter button.

The setting is right if you can view device WEB interface. Otherwise, please check the parameters.



Figure 4-170

4.8.1.8 UPnP

The UPnP protocol is to establish a mapping relationship between the LAN and the WAN. Please input the router IP address in the LAN in Figure 4-162. See Figure 4-171.

- UPNP on/off :Turn on or off the UPNP function of the device.
- Status: When the UPNP is offline, it shows as “Unknown”. When the UPNP works it shows “Success”
- Router LAN IP: It is the router IP in the LAN.
- WAN IP: It is the router IP in the WAN.
- Port Mapping list: The port mapping list here is the one to one relationship with the router’s port mapping setting.
- List:
 - ◇ Service name: Defined by user.
 - ◇ Protocol: Protocol type
 - ◇ Internal port: Port that has been mapped in the router.
 - ◇ External port: Port that has been mapped locally.
- Default: UPNP default port setting is the HTTP, TCP and UDP of the NVR.
- Add to the list: Click it to add the mapping relationship.
- Delete: Click it to remove one mapping item.

Double click one item; you can change the corresponding mapping information. See Figure 4-172.

Important:

When you are setting the router external port, please use 1024~5000 port. Do not use well-known port 1~255 and the system port 256~1023 to avoid conflict.

For the TCP and UDP, please make sure the internal port and external port are the same to guarantee the proper data transmission.



Figure 4-171



Figure 4-172

4.8.1.9 Email

The email interface is shown as below. See Figure 4-173.

- SMTP server: Please input your email SMTP server IP here.
- Port: Please input corresponding port value here.
- User name: Please input the user name to login the sender email box.

- Password: Please input the corresponding password here.
- Sender: Please input sender email box here.
- Title: Please input email subject here. System support English character and Arabic number. Max 32-digit.
- Receiver: Please input receiver email address here. System max supports 3 email boxes. System automatically filters same addresses if you input one receiver repeatedly.
- SSL enable: System supports SSL encryption box.
- Interval: The send interval ranges from 0 to 3600 seconds. 0 means there is no interval.
- Health email enable: Please check the box here to enable this function. This function allows the system to send out the test email to check the connection is OK or not.
- Interval: Please check the above box to enable this function and then set the corresponding interval. System can send out the email regularly as you set here. Click the Test button, you can see the corresponding dialogue box to see the email connection is OK or not.

Please note system will not send out the email immediately when the alarm occurs. When the alarm, motion detection or the abnormality event activates the email, system sends out the email according to the interval you specified here. This function is very useful when there are too many emails activated by the abnormality events, which may result in heavy load for the email server.

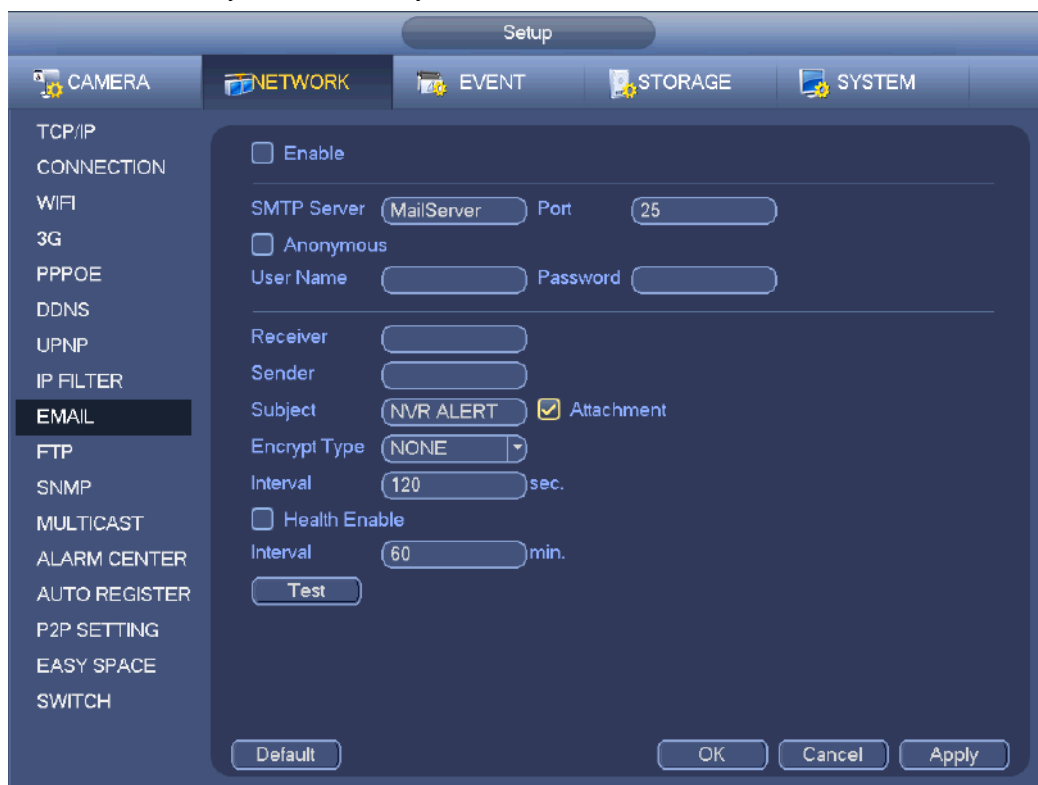

Figure 4-173

4.8.1.10 SNMP

SNMP is an abbreviation of Simple Network Management Protocol. It provides the basic network management frame of the network management system. The SNMP widely used in many environments. It is used in many network device, software and system.

You can set in the following interface. See Figure 4-174.



Figure 4-174

Please enable the SNMP function. Use the corresponding software tool (MIB Builder and MG-SOFT MIB Browser). You still need two MIB file: BASE-SNMP-MIB, NVR-SNMP-MIB) to connect to the device. You can get the device corresponding configuration information after successfully connection.

Please follow the steps listed below to configure.

- In Figure 4-174, check the box to enable the SNMP function. Input the IP address of the PC than is running the software in the Trap address. You can use default setup for the rest items.
- Compile the above mentioned two MIB file via the software MIB Builder.
- Run MG-SOFT MIB Browser to load the file from the previous step to the software.
- Input the device IP you want to manage in the MG-SOFT MIB Browser. Please set the corresponding version for your future reference.
- Open the tree list on the MG-SOFT MIB Browser; you can get the device configuration. Here you can see the device has how many video channels, audio channels, application version and etc.

Note

Port conflict occurs when SNMP port and Trap port are the same.

4.8.1.11 Multicast

Multicast setup interface is shown as in Figure 4-175.



Figure 4-175

Here you can set a multiple cast group. Please refer to the following sheet for detailed information.

- IP multiple cast group address
 - 224.0.0.0-239.255.255.255
 - “D” address space
 - The higher four-bit of the first byte=“1110”
- Reserved local multiple cast group address
 - 224.0.0.0-224.0.0.255
 - TTL=1 When sending out telegraph
 - For example
 - 224.0.0.1 All systems in the sub-net
 - 224.0.0.2 All routers in the sub-net
 - 224.0.0.4 DVMRP router
 - 224.0.0.5 OSPF router
 - 224.0.0.13 PIMv2 router
- Administrative scoped addressees
 - 239.0.0.0-239.255.255.255
 - Private address space
 - Like the single broadcast address of RFC1918
 - Cannot be used in Internet transmission
 - Used for multiple cast broadcast in limited space.

Except the above mentioned addresses of special meaning, you can use other addresses. For example:

Multiple cast IP: 235.8.8.36

Multiple cast PORT: 3666.

After you logged in the Web, the Web can automatically get multiple cast address and add it to the multiple cast groups. You can enable real-time monitor function to view the view. Please note multiple cast function applies to special series only.

4.8.1.12 Alarm Centre

This interface is reserved for you to develop. See Figure 4-176.



Figure 4-176

4.8.1.13 Auto register

This function allows the device to auto register to the proxy you specified. In this way, you can use the client-end to access the NVR and etc via the proxy. Here the proxy has a switch function. In the network service, device supports the server address of IPv4 or domain.

Please follow the steps listed below to use this function.

Please set proxy server address, port, and sub-device name at the device-end. Please enable the auto register function, the device can auto register to the proxy server.

1) The setup interface is shown as in Figure 4-177.

Important

Do not input network default port such as TCP port number.



Figure 4-177

2) The proxy server software developed from the SDK. Please open the software and input the global setup. Please make sure the auto connection port here is the same as the port you set in the previous step.

3) Now you can add device. Please do not input default port number such as the TCP port in the mapping port number. The device ID here shall be the same with the ID you input in Figure 4-177. Click Add button to complete the setup.

4) Now you can boot up the proxy server. When you see the network status is Y, it means your registration is OK. You can view the proxy server when the device is online.

Important

The server IP address can also be domain. But you need to register a domain name before you run proxy device server.

4.8.1.14 P2P

You can use your cell phone to scan the QR code and add it to the cell phone client.

Via the SN from scanning the QR code, you can access the device in the WAN. Please refer to the P2P operation manual included in the resources CD.

From main menu->Setting->Network->P2P, you can go to the following interface, the P2P interface is shown as in Figure 4-178.





Figure 4-178

Here we use cell phone APP to continue.

Step 1 Use cell phone to scan the QR code and download the APP.

Step 2 After installation, run the APP and Live Preview, enter the main interface. Now you can add device to the APP.

1. Open App; tap  to go to the Live preview.
2. Tap  at the top left corner, you can see the main menu.
3. Tap Device manager button, you can use several modes (P2P/DDNS/IP and etc.) to add the device. Click  to save current setup. Tap Start Live preview to view all-channel video from the connected device. See Figure 4-179.

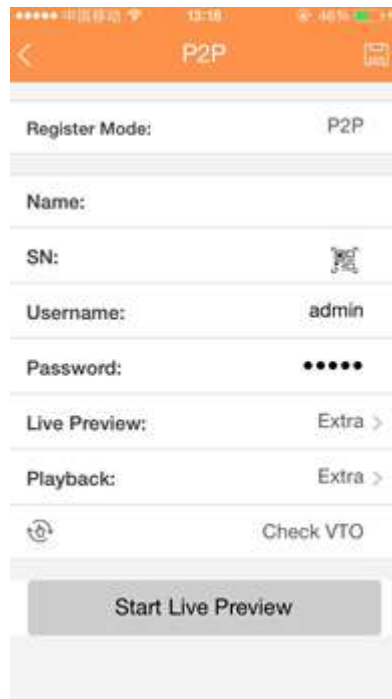

Figure 4-179

4.8.1.15 Easy Space

This function allows you to upload motion detect record or snapshot image to the dropbox and etc. The easy space interface is shown as below. See Figure 4-180.

Please select the easy space address from the dropdown list and then input corresponding user name and password.

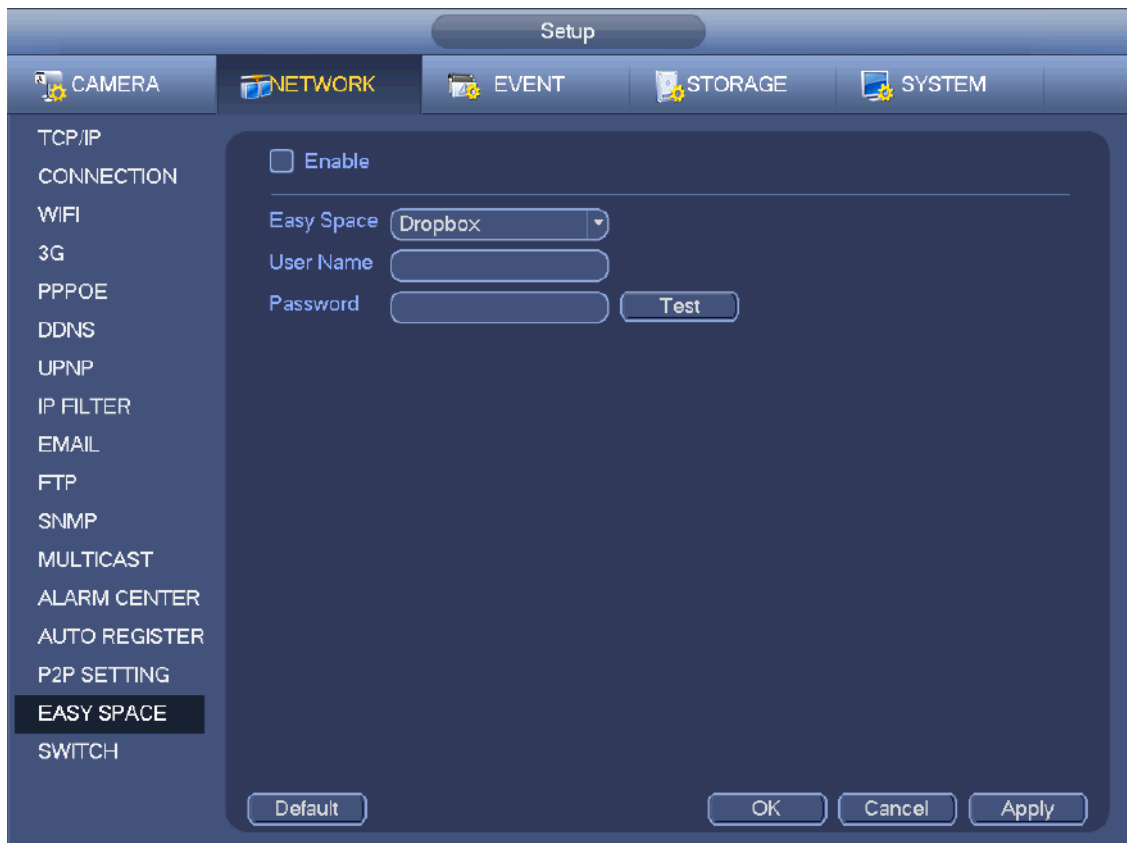

Figure 4-180

Note:

- The uploaded file is for sub stream only. Please go to record control interface (main stream->setting->Storage->Record) and then select sub stream.
- The easy space function uses upload bandwidth. Usually the recommended upload bandwidth shall be more than 512kbps and please make sure the network is stable.
- The easy space upload data adopts safe SSL encryption connection. Please enable 1-channel to upload in case this function occupies too much CPU.

4.8.1.16 SWITCH

When connect a network camera to the PoE port of the NVR, NVR can automatically allocate the IP address according to the specified IP segment. The network camera can automatically register to the NVR.

It is for you to set IP address, subnet mask, gateway and etc of the Switch. See Figure 4-181.



Caution

- This function is for product of PoE port.
- Do not connect switch to the PoE port, otherwise the connection may fail.
- The SWITCH function of the NVR is enabled by default. The IP segment is 10.1.1.1. Usually we recommend the default setup.
- For the camera from the third party, make sure the camera supports ONVIF and DHCP function is enabled.



Figure 4-181

Refer to the following table for PoE notice.

Type	Note
Connect camera to the PoE	<p>After connect the camera to the PoE, NVR allocate an IP address in the specified IP segment to the camera. NVR tries to use arp ping to set. If the NVR has enabled the DHCP function, it uses DHCP to set.</p> <ul style="list-style-type: none"> ● After successfully set IP address, NVR can send out broadcast via the switch and get the corresponding response. Now The camera has registered to the NVR. Go to the preview interface, the corresponding channel has been used and there is a small PoE icon at the top left corner. ● Go to the Register interface to view the connected device list, you can see the PoE channel number, PoE port information and etc. Click IP search to display or refresh the information.
Remove camera from the PoE port	<p>After remove the camera network cable from the PoE port, the channel displays "Cannot find the network host". On the registration interface, the IP address is shown as offline.</p>
The mapping policy when connect a camera to the PoE port.	<p>The PoE port and the channel window is one to one correspondence. For example, connect a network camera to PoE port 1, it register to channel 1 by default.</p>

4.8.2 Network Test

In this interface, you can see network test and network load information.

4.8.2.1 Network Test

From main menu->Info-Network->Test, the network test interface is shown as in Figure 4-182.

- Destination IP: Please input valid IPV4 address and domain name.
- Test: Click it to test the connection with the destination IP address. The test results can display average delay and packet loss rate and you can also view the network status as OK, bad, no connection and etc.
- Network Sniffer backup: Please insert USB2.0 device and click the Refresh button, you can view the device on the following column. You can use the dropdown list to select peripheral device. Click Browse button to select the snap path. The steps here are same as preview backup operation.

You can view all connected network adapter names (including Ethernet, PPPoE, WIFI, and 3G), you can click the button  on the right panel to begin Sniffer. Click the grey stop button to stop. Please note system cannot Sniffer several network adapters at the same time.

After Sniffer began, you can exit to implement corresponding network operation such as login WEB, monitor. Please go back to Sniffer interface to click  stop Sniffer. System can save the packets to the specified path. The file is named after "Network adapter name+time". You can use software such as Wireshark to open the packets on the PC for the professional engineer to solve complicated problems.

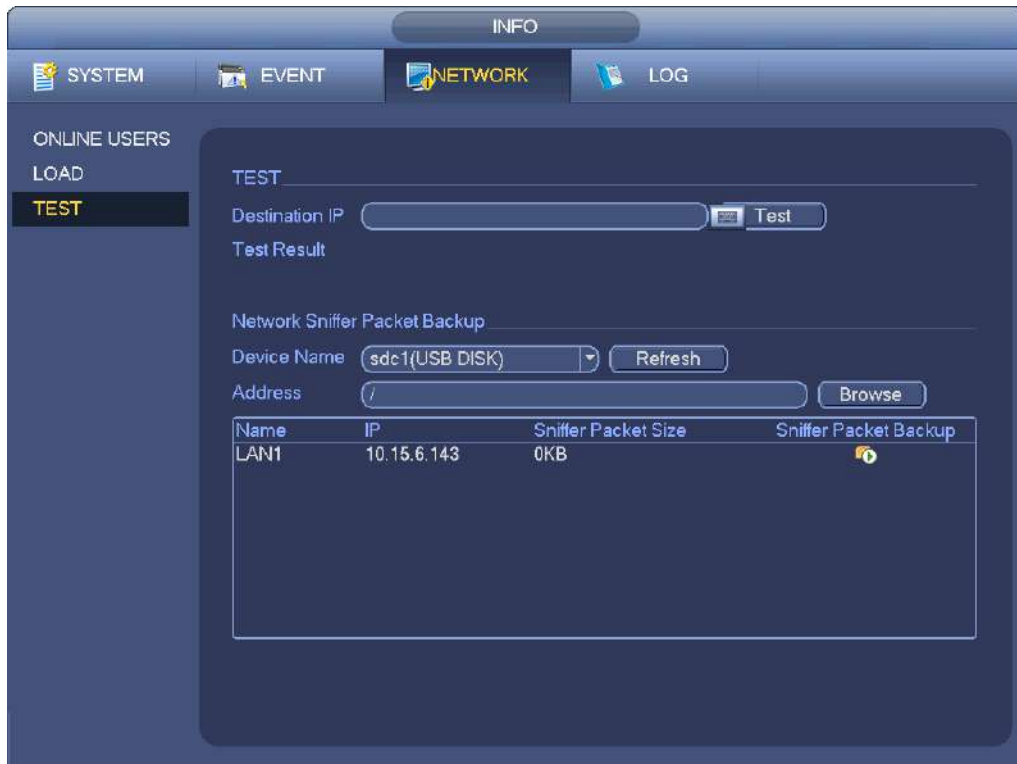

Figure 4-182

4.8.2.2 Network Load

From main menu->Info-Network->Load, network load is shown as in Figure 4-183. Here you can view the follow statistics of the device network adapter.

Here you can view information of all connected network adapters. The connection status is shown as offline if connection is disconnected. Click one network adapter, you can view the flow statistics such as send rate and receive rate at the top panel.

Note

- It is to display LAN1 network load by default.
- View one LAN network load by one time.



Figure 4-183

4.9 Storage

Here you can view HDD information such as type, status, total capacity, record time and etc. The operation includes format, resume from error, change HDD property (Read write, Read-only). Here you can also set alarm and HDD storage position.

4.9.1 Basic

It is to manage HDD storage space.

Step 1 From main menu->Setup->Storage->Basic.

Enter Basic interface. See Figure 5-43.

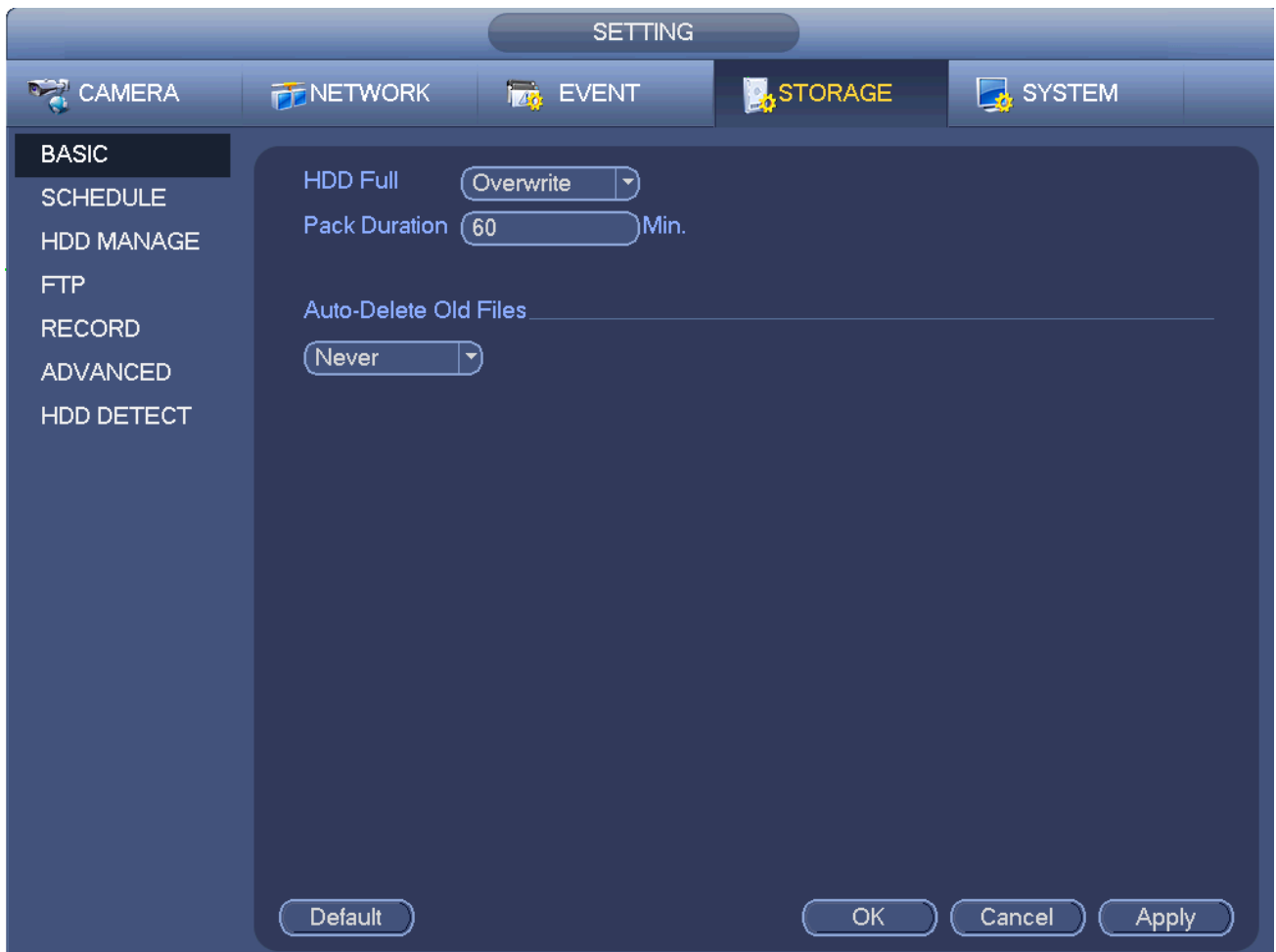

Figure 4-184

Step 2 Set parameters.

- HDD full: It is to select working mode when hard disk is full. There are two options: stop recording or rewrite.
- Pack duration: It is to specify record duration. The max length is 120 minutes.
- Auto delete old files:
 - ✧ Never: Do not auto delete old files.
 - ✧ Customized: input customized period here, system can auto delete corresponding old files.

Step 3 Click Apply or Save to complete setup.

4.9.2 Schedule

It is to set schedule record and schedule snapshot. NVR can record or snapshot as you specified. For detailed information, please refer to chapter 4.1.4.6.1 schedule record and 4.1.4.6.2 schedule snapshot.

4.9.3 HDD

It is to view and sett HDD properties and format HDD.

It is to view current HDD type, status, capacity and etc. The operation includes format HDD, and change HDD property (read and write/read-only/redundancy).

- To prevent files be overwritten in the future, you can set HDD as read-only.
- To backup recorded video file, you can set HDD as redundant HDD.

Step 1 From Mani-menu->Setting->Storage->HDD Manager, you can go to HDD management interface. See Figure 4-185.

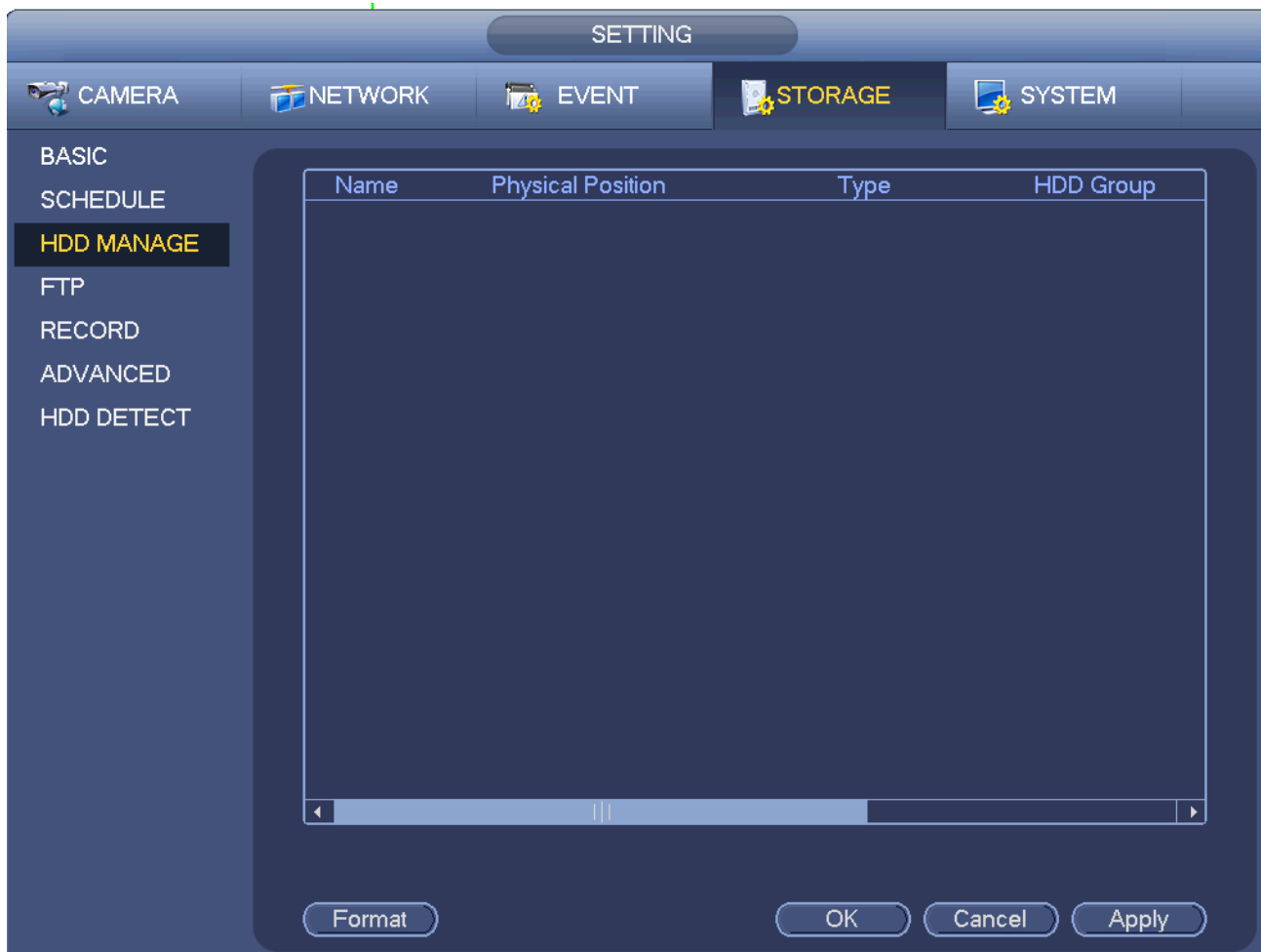

Figure 4-185

Step 2 Select a HDD and then select an time from the dropdown list. Click Execute button.

Step 3 Click OK button to complete the setup. You can see system needs to restart to activate current setup if you want to format the HDD.

4.9.4 FTP

It is to backup record file or image to the FTP to storage or view.

Before the operation, please download or purchase the FTP service tool and install on the PC.



Note

For the FTP user, please set FTP folder write right, otherwise system cannot upload the image.

Step 1 From main menu->Setting->Storage->FTP, enter FTP interface. See Figure 4-186.

Step 2 Set parameters.

Here you can input FTP server address, port and remote directory. When remote directory is null, system automatically create folders according to the IP, time and channel.

- Host IP: The host IP you have installed the FTP server.
- Host port: The default setup is 21.
- User name/Password: The account for you to access the FTP server.
- Remote directory: The folder you created under the root path of the FTP according to the corresponding rule.

◇ If there is no remote directory, system can auto create different directories according to the IP, time and channel.

- ✧ If there is remote directory, system can create corresponding folder under the FTP root path and then create different folders according to IP address, time and channel.
 - File length: File length is upload file length. When setup is larger than the actual file length, system will upload the whole file. When setup here is smaller than the actual file length, system only uploads the set length and auto ignore the left section. When interval value is 0, system uploads all corresponding files.
 - Image upload interval: It is the image upload interval. If the image upload interval is larger than the image snapshot frequency, system just uploads the lasted image.
 - ✧ If the image interval is 5 seconds and the snapshot frequency is 2 seconds, system will send out the latest image at the buffer at 5 seconds.
 - ✧ If the image upload interval is smaller than the snapshot frequency, system will upload at the snapshot frequency. For example, if the image interval is 5 seconds and the snapshot frequency is 10 seconds, system will send out the image at 10 seconds.
 - ✧ From main menu->Setting->Camera->Encode->Snapshot to set snapshot frequency.
 - Channel: Select a channel from the dropdown list and then set week, period and record type.
 - Week day/Period: Please select from the dropdown list and for each day, you can set two periods.
 - Type: Please select uploaded record type (Alarm/intelligent/motion detect/regular). Please check the box to select upload type.
- Step 3 Click the Test button, you can see the corresponding dialogue box to see the FTP connection is OK or not.
- Step 4 Click Apply or Save to complete setup.



Figure 4-186

4.9.5 Record Control

After you set schedule record or schedule snapshot function, please set auto record/snapshot function so

that the NVR can automatically record or snapshot. For detailed information, please refer to chapter 4.1.4.6.3 record control.

4.9.6 HDD Information

Here is to list hard disk type, total space, free space, and status. See Figure 4-187.

○ means current HDD is normal.. - means there is no HDD.

If disk is damaged, system shows as “?”. Please remove the broken hard disk before you add a new one.

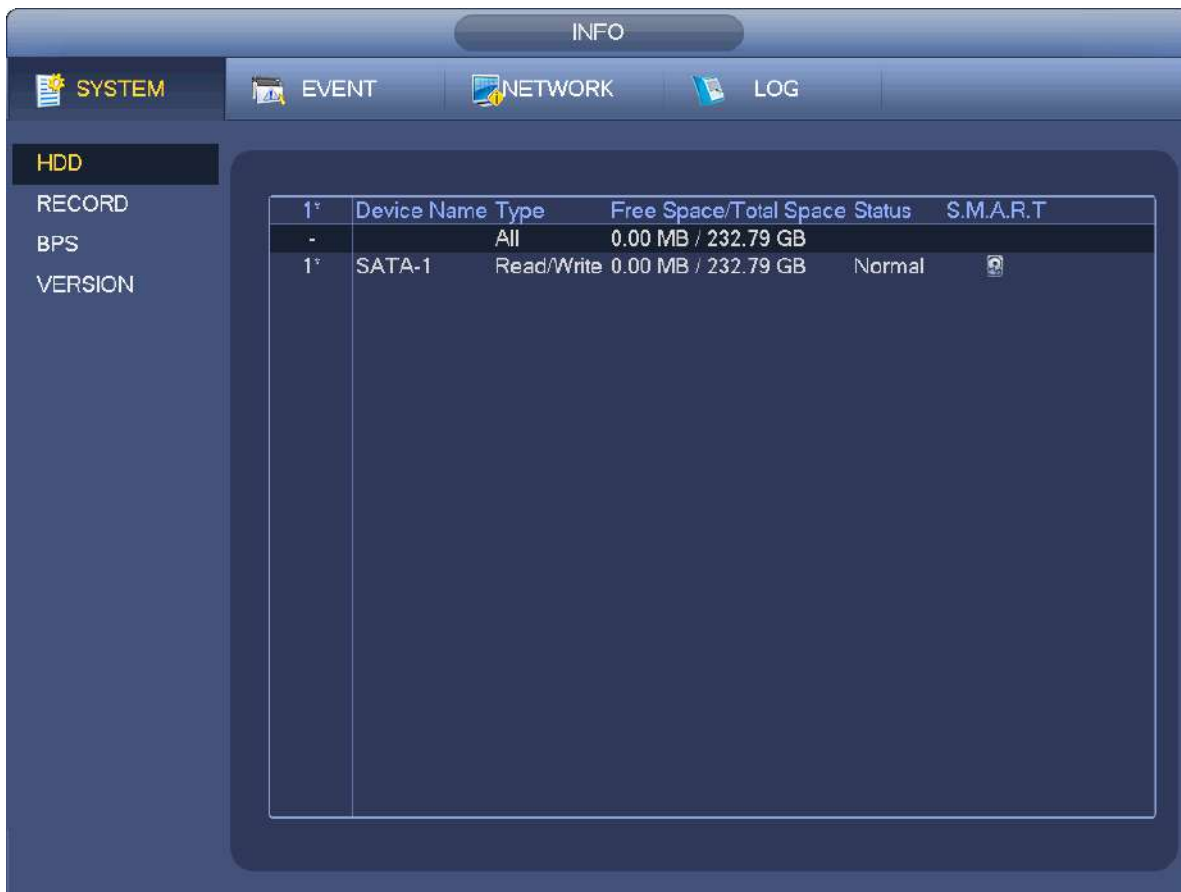

Figure 4-187

In Figure 4-187, click one HDD item, the S.M.A.R.T interface is shown as in Figure 4-188.

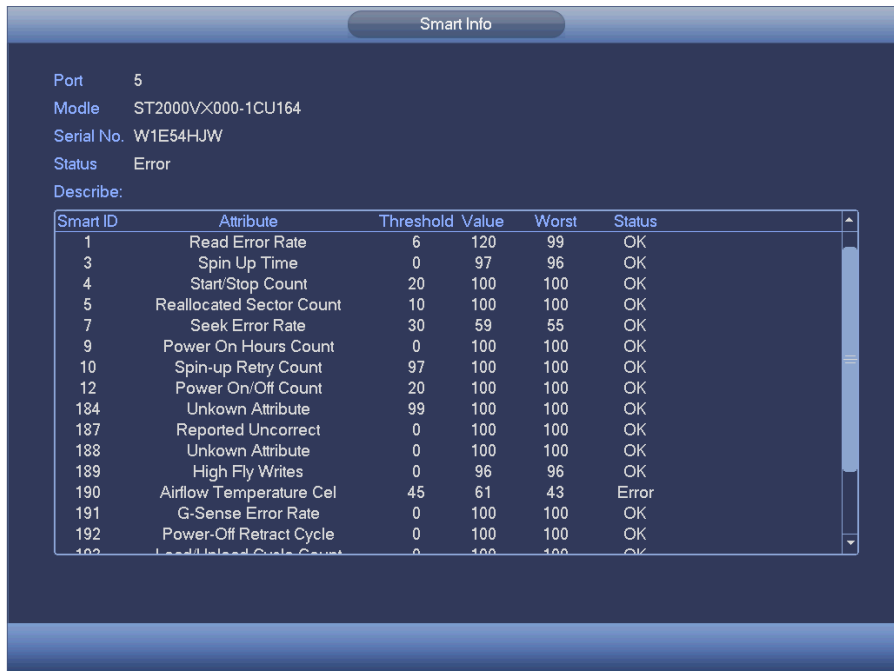

Figure 4-188

Parameter	Function
SATA	1 here means there is 1 HDD. For different series product, the max HDD amount may vary, When HDD is working properly, system is shown as O. . “_” means there is no HDD.
SN	You can view the HDD amount the device connected to; * means the second HDD is current working HDD.
Type	The corresponding HDD property.
Total space	The HDD total capacity.
Free space	The HDD free capacity.
Status	HDD can work properly or not.
Bad track	Display there is bad track or not.
Page up	Click it to view previous page.
Page down	Click it to view the next page.
View recording time	Click it to view HDD record information (file start time and end time).
View HDD type and capability	Click it to view HDD property, status and etc,

4.9.7 HDD Group

It is to set HDD group, and HDD group setup for main stream, sub stream and snapshot operation.



Caution

When you are setting HDD group, please set a HDD for each channel, otherwise NVR cannot save current setup.

The main stream is shown as in Figure 4-189.

- HDD: Here you can view the HDD amount the device can support.
- Group: It lists the HDD Group number of current hard disk.

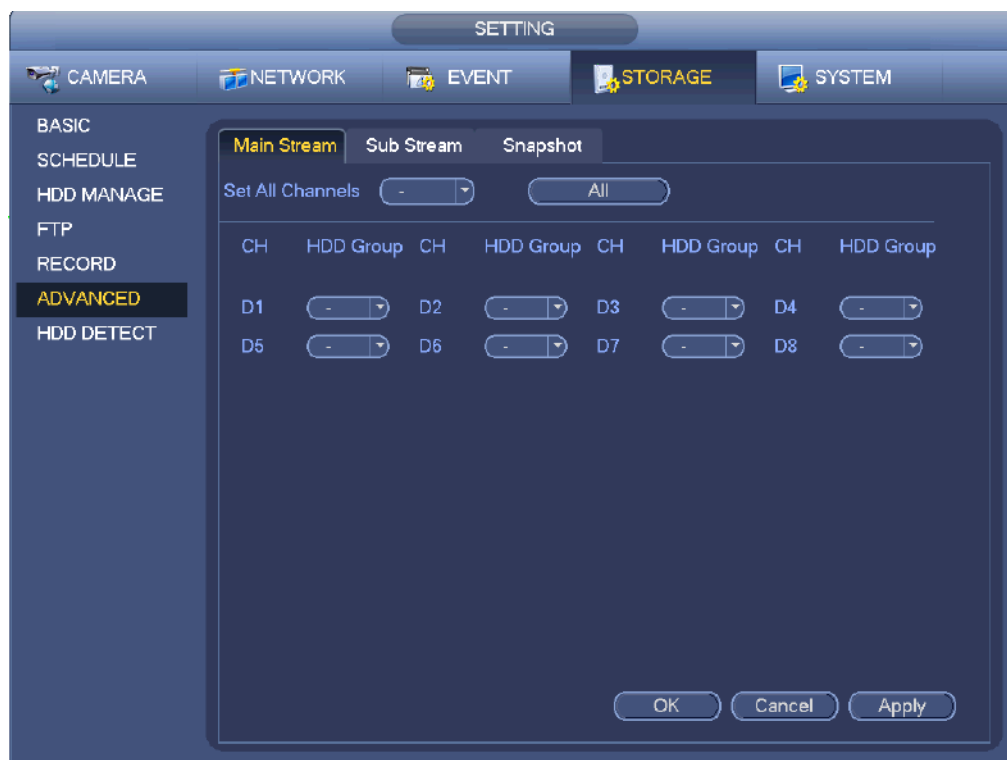

Figure 4-189

Please select the correspond group from the dropdown list and then click Apply button. Click sub stream/snapshot button to set corresponding HDD group information.

4.9.8 HDD Detect



Note

This function is for some series product only.

The HDD detect function is to detect HDD current status so that you can clearly understand the HDD performance and replace the malfunction HDD.

There are two detect types:

- Quick detect is to detect via the universal system files. System can quickly complete the HDD scan. If you want to use this function, please make sure the HDD is in use now. If the HDD is removed from other device, please make sure the write-data once was full after it installed on current device.
- Global detect adopts Windows mode to scan. It may take a long time and may affect the HDD

that is recording.

4.9.8.1 Manual Detect

From main menu->Setting->Storage->HDD Detect->Manual Detect, the interface is shown as below. See Figure 4-190.

Please select detect type and HDD. Click start detect to begin. You can view the corresponding detect information.

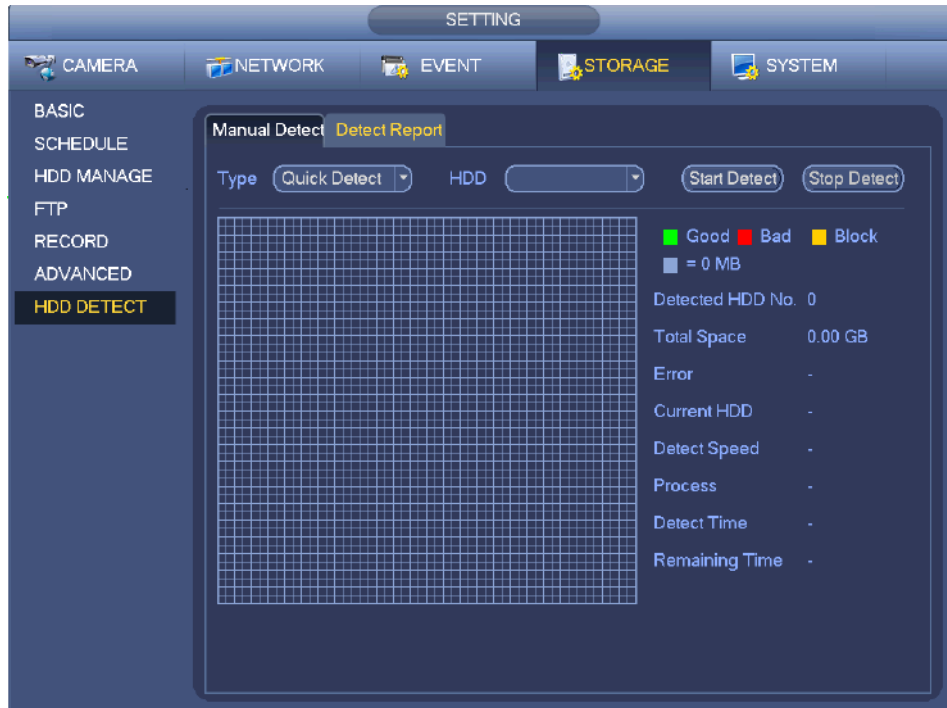

Figure 4-190

4.9.8.2 Detect Report

After the detect operation, you can go to the detect report to view corresponding information.

From main menu->Setting->Storage->HDD Detect->Manual Detect, the interface is shown as below. See Figure 4-191.

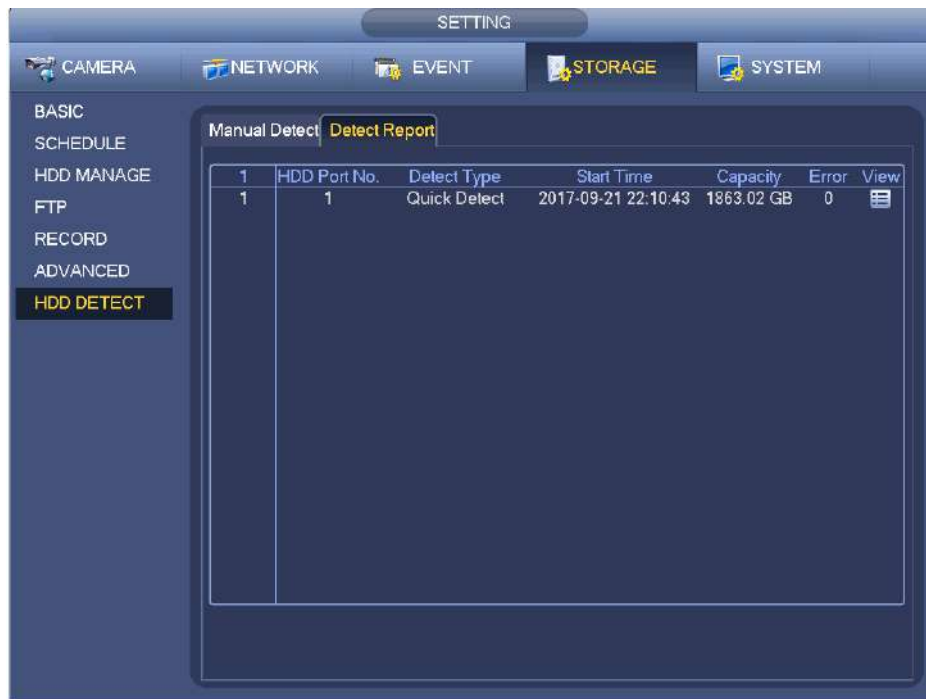

Figure 4-191

Click View, you can see the detailed information such as detect result, backup and S.M.A.R.T. See Figure 4-192 and Figure 4-193.



Figure 4-192



Figure 4-193

4.9.9 RAID Manager

RAID (redundant array of independent disks) is a data storage virtualization technology that combines multiple physical HDD components into a single logical unit for the purposes of data redundancy, performance improvement, or both.



Note

- RAID function is for some series product only. Slight difference may be found on the user interface.
- Right now, NVR supports RAID0, RAID1, RAID5, RAID6, and RAID 10. Local hotspare supports RAID1, RAID5, RAID6, and RAID10.
- Refer to the following table for detailed information.

RAID Type	HDD Amount
RAID0	At least 2 HDDs.
RAID1	Only 2 HDDs.
RAID5	At least 3 HDDs. Usually recommend the RAID5 consists of 4 to 6 HDDs.
RAID6	At least 4 HDDs.
RAID10	At least 4 HDDs.

4.9.9.1 RAID Config

It is for you to manage RAID HDD. It can display RAID name, type, free space, total space, status and etc. Here you can add/delete RAID HDD.

Click Add button to select RAID type and then select HDDs, click OK button to add. See Figure 4-194.

One click to create RAID

- Click it to automatically create RAID5.
- For create RAID function, you can select the physical HDD that does not included in the RAID group or the created disk array to create a RAID5. You can refer to the following situations:
- There is no RAID, no hotspare disk: System directly creates the RAID5 and creates one hotspare disk at the same time.
- There is no RAID, but there is a hotspare disk: System creates the RAID5 only. It uses previous hotspare disk.
- There is RAID: System cancel the previous RAID setup and then create the new RAID5. System creates the hotspare disk if there is no one. System uses previous hotspare disk if there is hotspare disk available.
- The background will format the virtual disk.

Create manually

Step 1 Select RAID type first and then follow the prompts to set HDD amount.

Step 2 Click Create Manually button, system pops up dialogue box to warning you it is going to clear all data.

Step 3 Click OK button to complete the operation.



Note

Click  to delete RAID.

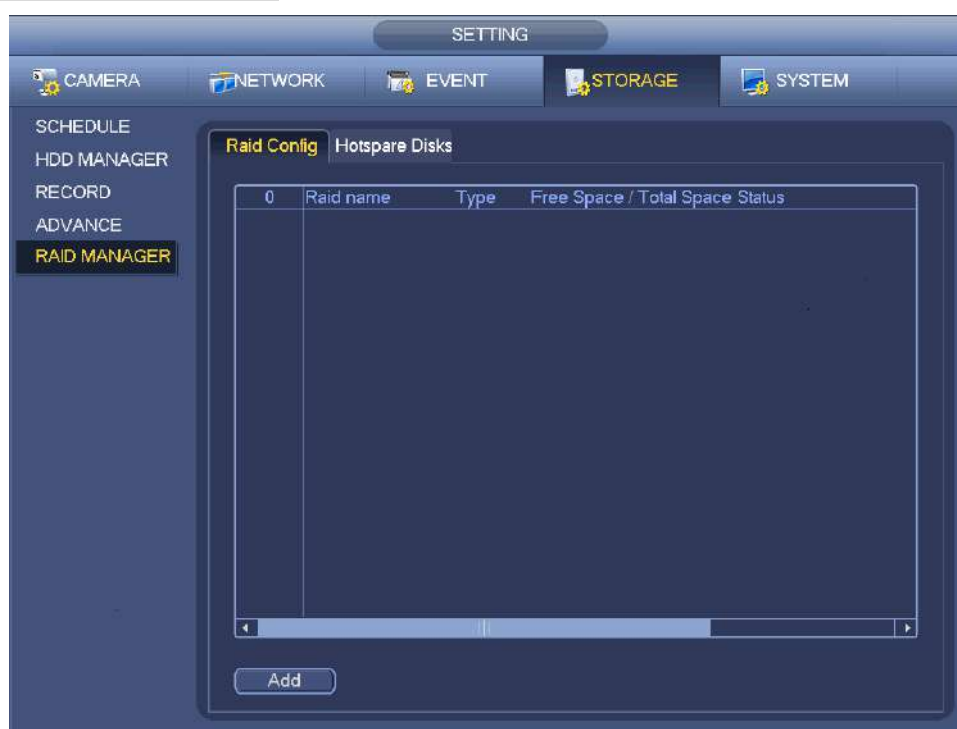

Figure 4-194

4.9.9.2 Hotspare disks

When a HDD of the RAID group is malfunction or abnormal, the hotspare HDD can replace the malfunction or abnormal HDD in case there is any data loss. It is to guarantee storage system reliability. Click Hotspare disks tab name, you can add the hot spare HDD. See Figure 4-195. The type includes two options:

- Global: It is global hotspare disk. When any RAID becomes degrading, it can replace and build the RAID.
- Local: It is local hotspare disk. When the specified RAID becomes degrading, it can replace and build the RAID.

Select a hot spare device and then click Delete button. Click Apply button to delete.

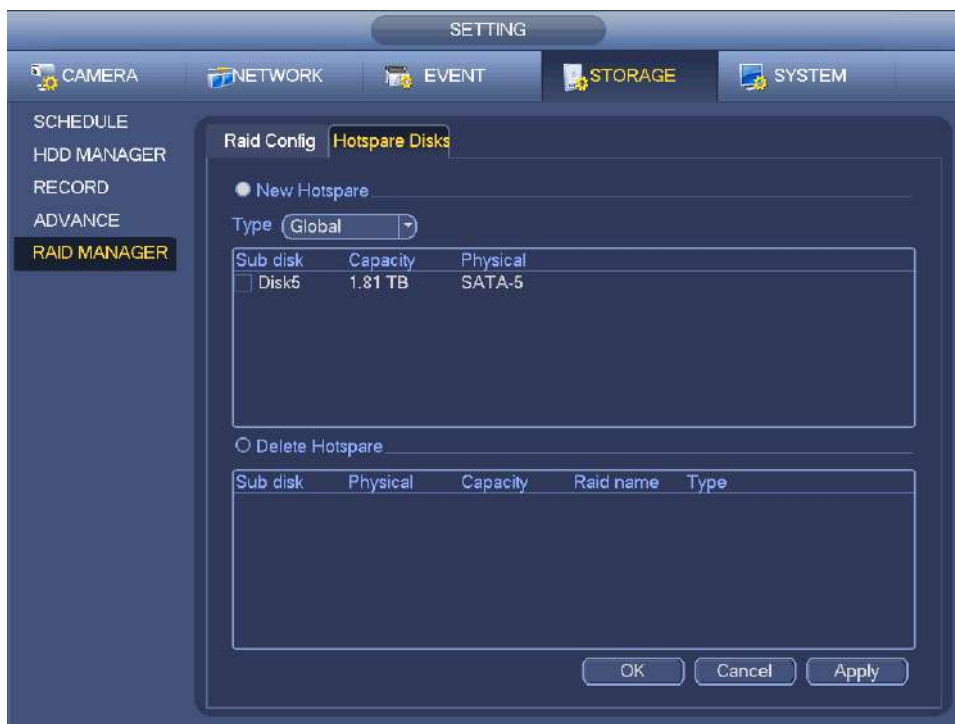

Figure 4-195

4.10 Device Maintenance and Manager

4.10.1 Account

It is to manage users, user group and ONVIF user, set admin security questions.

Note

- For the user name, the string max length is 31-byte, and for the user group, the string max length is 15-byte. The user name can only contain English letters, numbers and “_”、“@”、“.”.
- The default user amount is 64 and the default group amount is 20. System account adopts two-level management: group and user. The user authorities shall be smaller than group authorities (The **admin** user authorities are set by default).
- For group or user management, there are two levels: admin and user. The user name shall be unique and one user shall only belong to one group.

4.10.1.1 User

4.10.1.1.1 Add User

Step 1 From main menu->Setting->System->Account->User.

Enter user interface. See Figure 4-196.

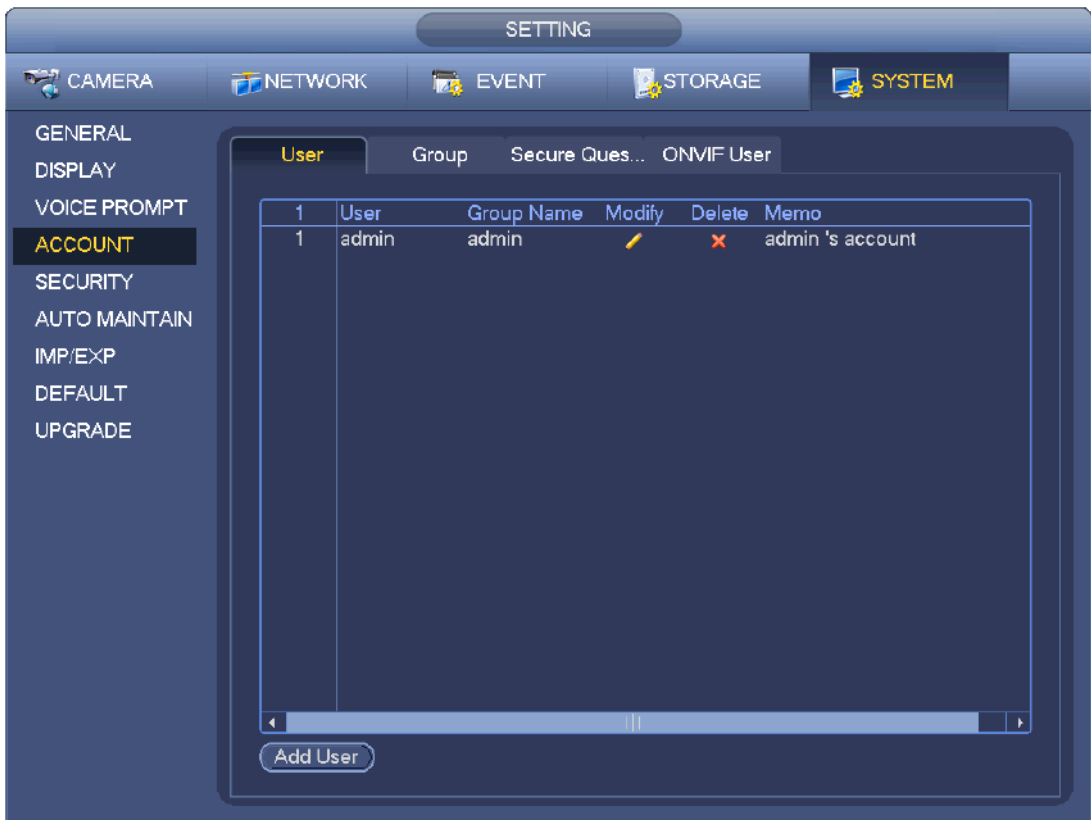

Figure 4-196

- Step 2 Click Add user button in Figure 4-196.
The interface is shown as in Figure 4-197.



Figure 4-197

- Step 3 Input the user name, password, select the group it belongs to from the dropdown list. Then you

can check the corresponding rights for current user.

 **Note**

For convenient user management, usually we recommend the general user right is lower than the admin account.

Step 4 Click the Set button after the period, you can set valid period to use current account. See Figure 4-198.

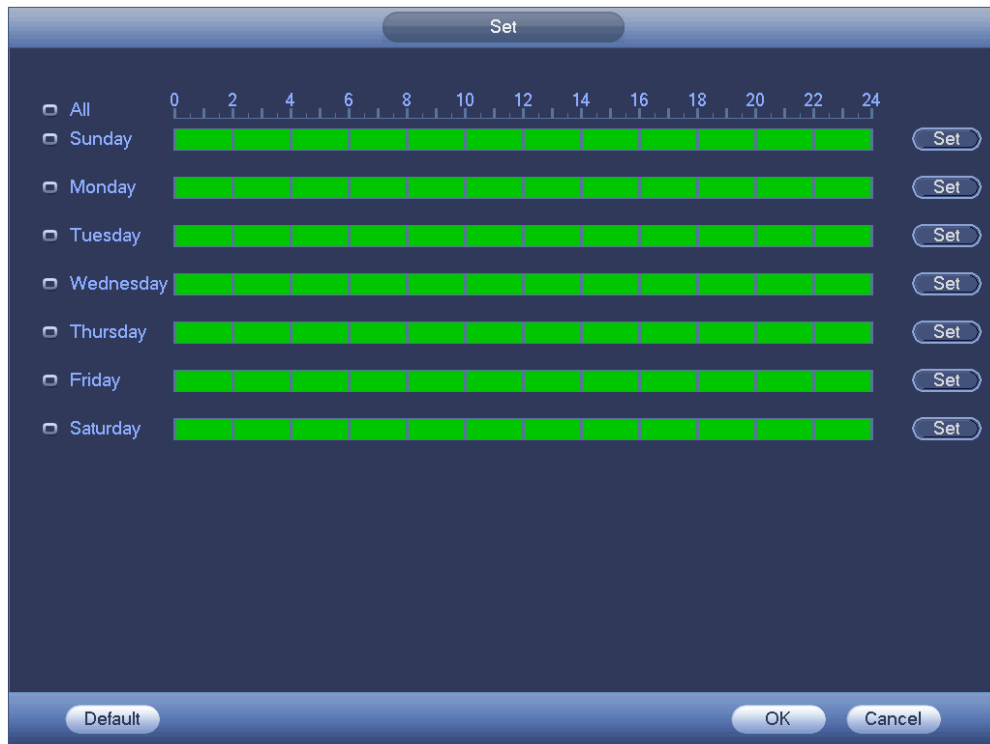

Figure 4-198

Step 5 Click Set button, you can set six periods in one day. See Figure 4-199.

Step 6 Check the box after the period, you can enable current setup.

 **Note**

Check the box before the week; it is to save period settings to selected week day.



Figure 4-199

Step 7 Click OK button.

4.10.1.1.2 Modify user

From main menu->Setting->System->Account->User, click , you can go to the following interface to change user information. See Figure 4-200.



Figure 4-200

For **admin** user, you can change the email, enable/disable unlock pattern, change password prompt question, set security questions. See Figure 4-201.

The screenshot shows the 'Modify User' window for the 'admin' user. The 'User Name' is set to 'admin'. The 'Group' is 'admin' and the 'Memo' is 'admin's account'. The 'Prompt Question' is 'c111111'. The 'Unlock Pattern' checkbox is checked. The 'Authority' section is set to 'System' and shows a grid of checked checkboxes for various system components: All, ACCOUNT, STORAGE, SECURITY, SYSTEM, EVENT, BACKUP, SYSTEM INFO, NETWORK, DEVICE MAINT..., MANJAL CONT..., and CAMERA. The 'Save' and 'Cancel' buttons are at the bottom right.

Figure 4-201

- Input email information and then click Save, it is to set/change email address.
- Check the box to enable unlock pattern and then click , click Save to change unlock pattern.
- Set security question

Step 1 Click Security question, enter the following interface. See Figure 4-202.

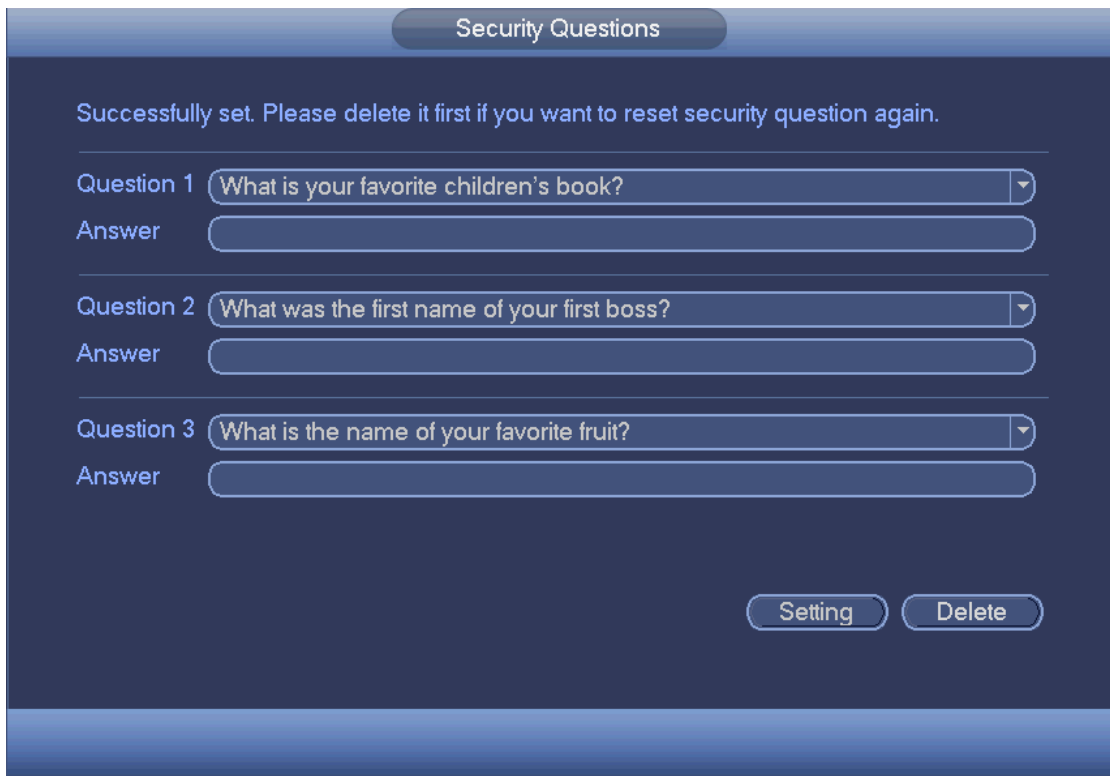

Figure 4-202

Step 2 Input answers and then click Save button.

After successfully set security questions, you can answer the security questions to reset admin password.

 **Note**

Select security questions from the dropdown list and then input the proper answers, click Delete button to reset security questions and answers again.

4.10.1.1.3 Change Password

In Figure 4-200, check the Modify password box, you can change password. Please input old password, and then input new password twice to confirm.

- Password/confirm password: The password ranges from 8 to 32 digitals. It can contain letters, numbers and special characters (excluding “”, “'”, “;”, “:”, “&”) . The password shall contain at least two categories. Usually we recommend the strong password.



WARNING

STRONG PASSWORD RECOMMENDED-For your device own safety, please create a strong password of your own choosing. We also recommend you change your password periodically especially in the high security system.

4.10.1.2 Modify Group

Step 1 From main menu->Setting->System->Account->Group.

Enter add group interface. See Figure 4-203.

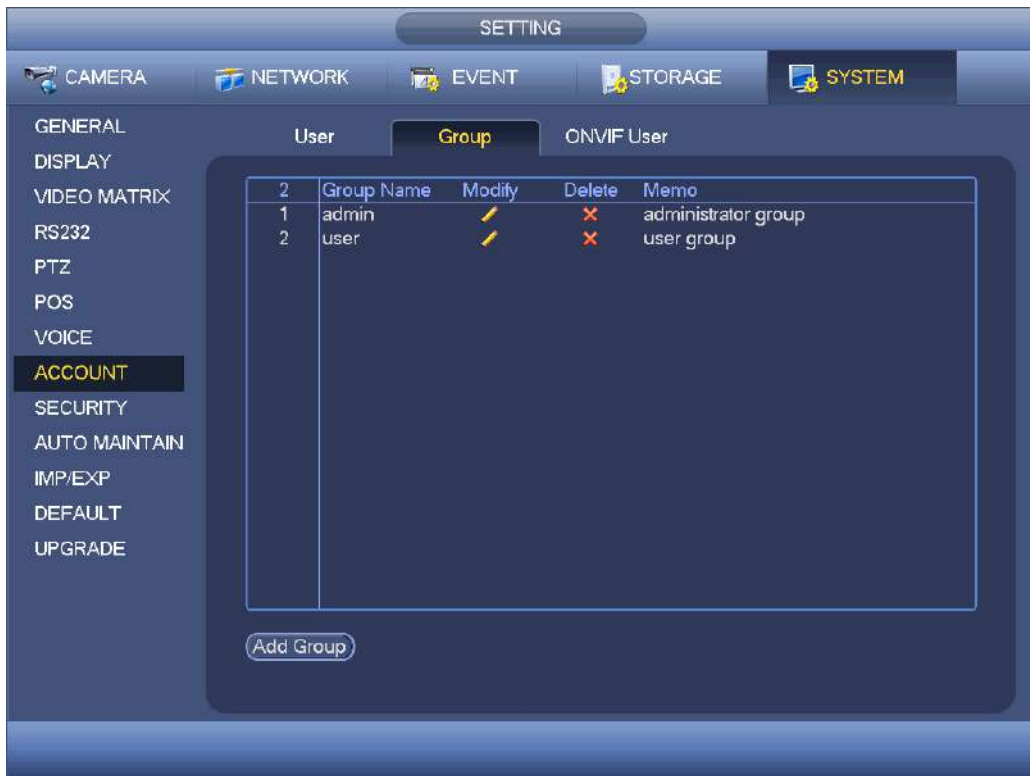

Figure 4-203

- Step 2 Click add group button in Figure 4-203.
Enter Add group the interface. See Figure 4-204.
- Step 3 Input group name and then input some memo information if necessary. Check the box to select authorities.



Figure 4-204

4.10.1.3 Security Question

Note

This function is for **admin** user only.

Here you can change security questions. After you successfully answered security questions, you can reset admin account password.

From main menu->Setting->System->Account->Security question, the interface is shown as below. See Figure 4-205. Input correct security answers and then click Delete button at the bottom of the interface, you can reset security questions and answers.

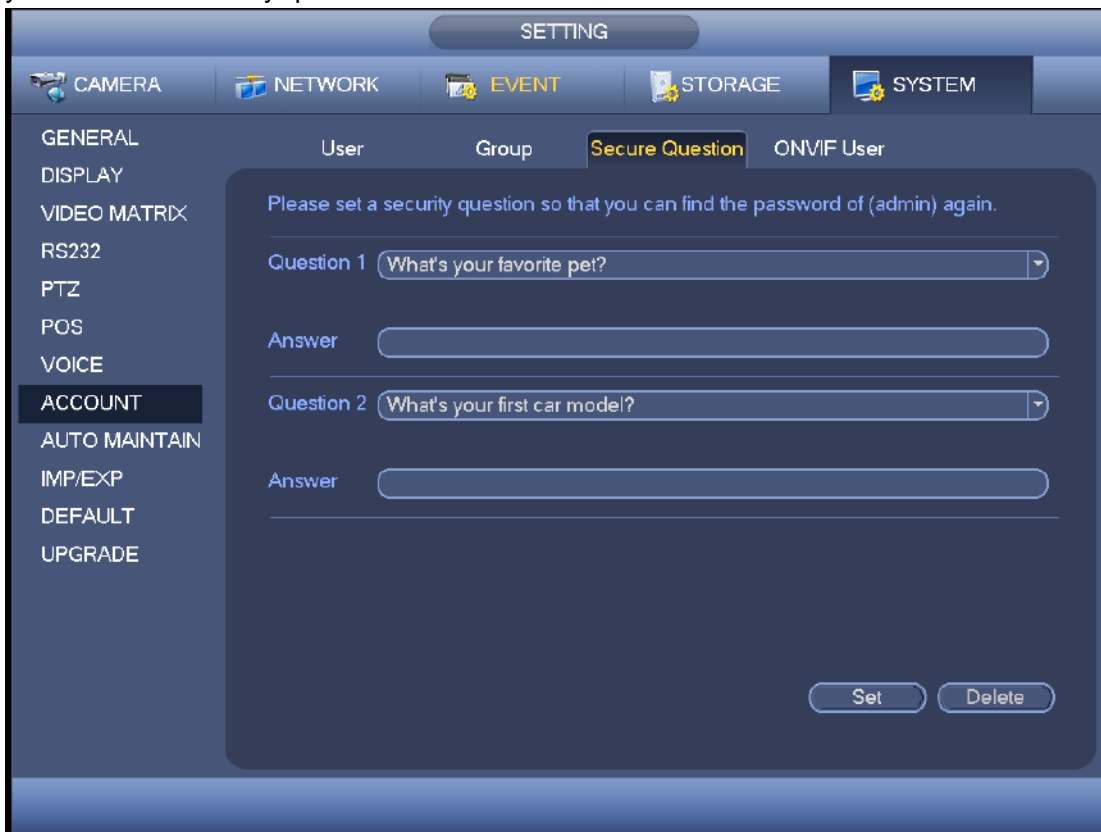

Figure 4-205

4.10.1.4 ONVIF User

When the camera from the third party is connected with the DVR via the ONVIF user, please use the verified ONVIF account to connect to the DVR. Here you can add/delete/modify user

Note

The default ONVIF user is **admin**. It is created after you initialize the DVR.

Step 1 From main menu->Setting->System->Account->ONVIF User.

Enter ONVIF interface. See Figure 4-206.

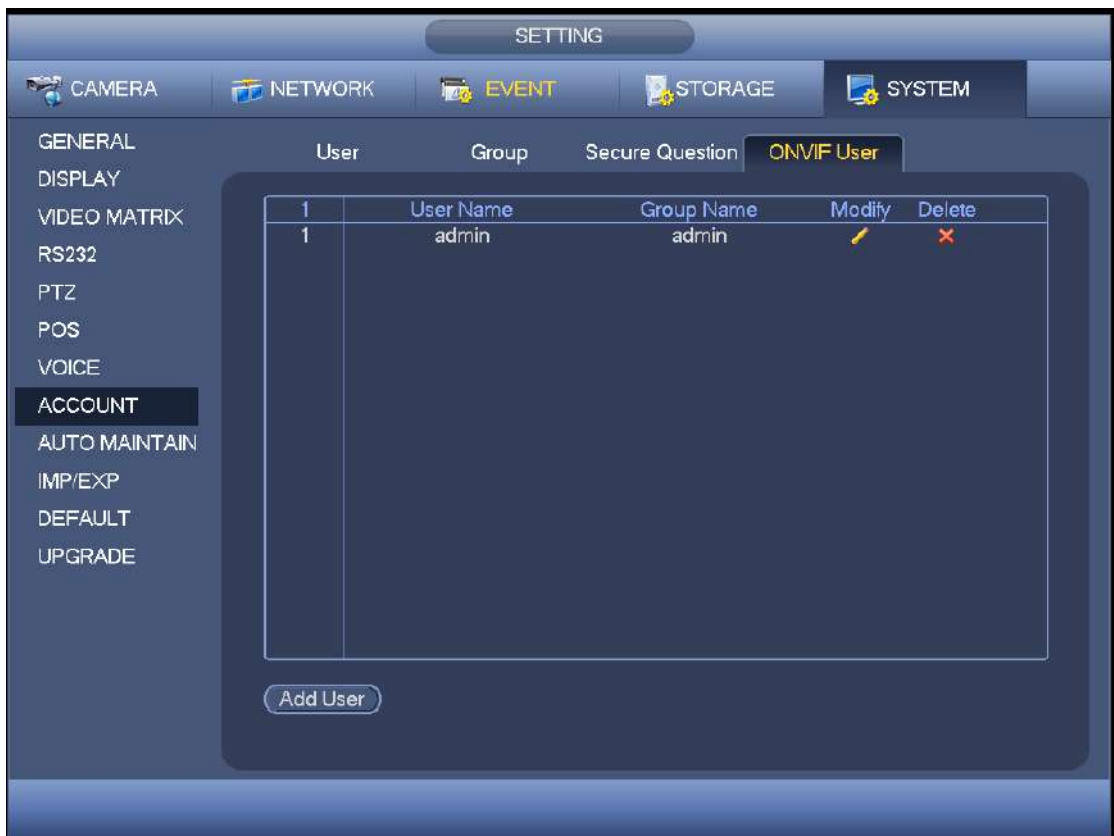

Figure 4-206

- Step 2 Click Add user button.
 Enter Add user interface. See Figure 2-43.

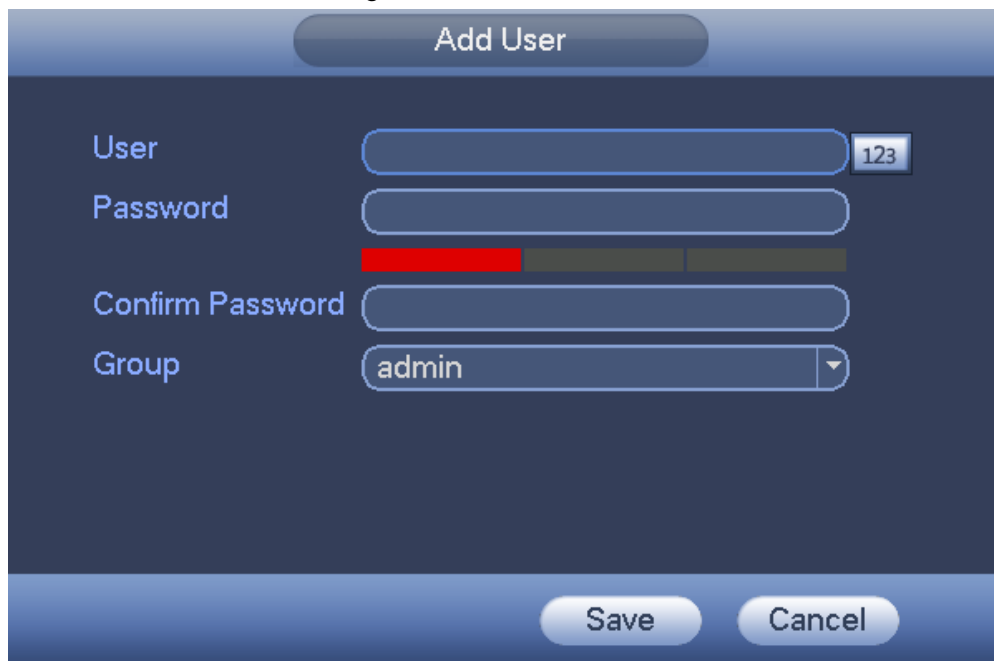

Figure 4-207

- Step 3 Set user name, password and then select group from the dropdown list.
 Step 4 Click Save to complete setup.

Note

Click  to change user information, click  to delete current user.

4.10.1.5 Online User

Here is for you manage online users connected to your NVR. See Figure 4-208.

You can click button  to disconnect or block one user if you have proper system right.

System detects there is any newly added or deleted user in each five seconds and refresh the list automatically.

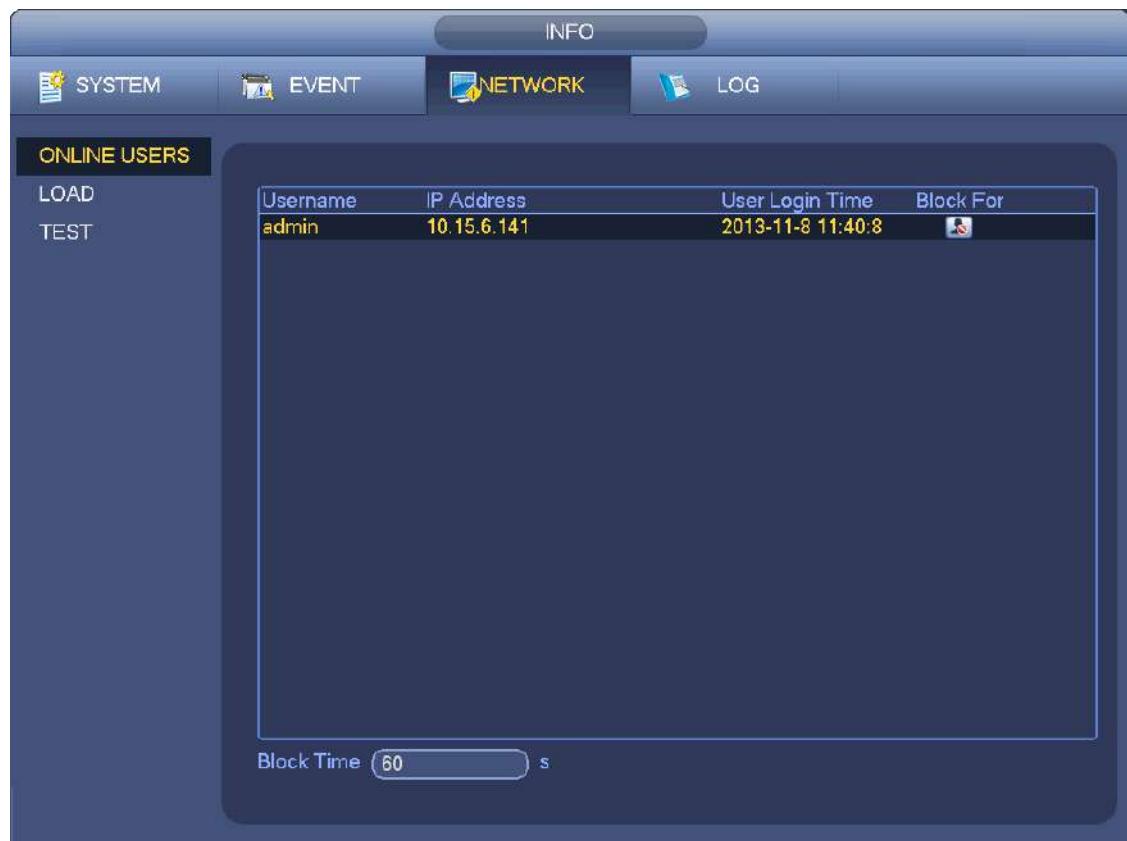

Figure 4-208

4.10.2 System Info

4.10.2.1 Version

From main menu->Info->System->version, you can go to version interface.

It is to view NVR version information. Slight different may be found on the user interface.

4.10.2.2 BPS

Here is for you to view current video bit rate (kb/s) and resolution. See Figure 4-209.

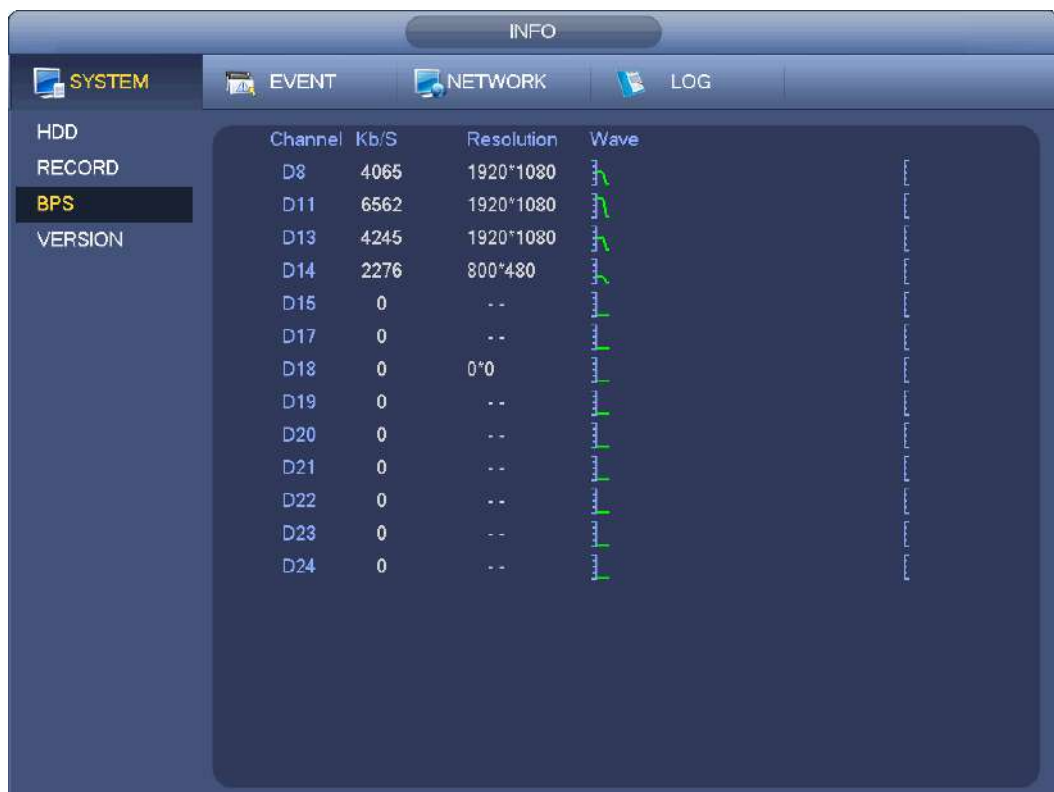

Figure 4-209

4.10.2.3 Event Information

4.10.2.3.1 Alarm Status

From main menu->info-Event, here you can view the channel status of the remote device, connection log and etc. See Figure 4-210.



Figure 4-210

4.10.2.3.2 People Counting

This function allows system to detect the people flow amount in the specified zone and display the people amount statistics image.

From main menu->Info->Event->People Counting, you can go to the following interface. See Figure 4-211.

Channel: Please select a channel from the dropdown list.

- Type: Please select report type from the dropdown list. It includes daily report/monthly report/annual report. You can click to select histogram or polygon chart.
- Start time/end time: Input start time and end time of the people counting.
- Enter: Check to search enter amount.
- Exit: Check the box to search exit amount.
- Display No.: Check the box, system can display enter and exit people amount in the report.



Figure 4-211

4.10.2.3.3 Heat Map

It is to search and view the heat map of each channel.

From main menu->Info->Event->Heat Map, you can go to the following interface. See Figure 4-212.

Select a channel, input start time and end time. Please note the report search period shall be within one month.

Click Search button, you can view the heat map report.



Figure 4-212

4.10.3 Voice

The audio function is to manage audio files and set schedule play function. It is to realize audio broadcast activation function.

Note

This function is for some series product only.

4.10.3.1.1 File Manage

Here you can add audio file, listen to the audio file, or rename/delete audio file. Here you can also set audio volume. See Figure 4-213.



Figure 4-213

Click Add button, you can add audio file and import the audio file via the USB device. The audio file format shall be MP3 or PCM. See Figure 4-214.

Note

The file size shall be 2K-10MB.



Figure 4-214

4.10.3.1.2 Schedule

It is to set schedule broadcast function. You can play the different audio files in the specified periods. See Figure 4-215.



Figure 4-215

4.10.4 RS232

After setting RS232 parameters, the NVR can use the COM port to connect to other device to debug and operate.

From Main menu->Setting->System->RS232, RS232 interface is shown as below. There are five items. See Figure 4-216.

- Function: There are various devices for you to select.
 - ✧ Console is for you to use the COM or mini-end software to upgrade or debug the program.
 - ✧ Control keyboard is for you to control the device via the special keyboard.
 - ✧ Transparent COM (adapter) is to connect to the PC to transfer data directly.
 - ✧ Protocol COM is for card overlay function.
 - ✧ Network keyboard is for you to use the special keyboard to control the device.
 - ✧ PTZ matrix is to connect to the peripheral matrix control.

Note

Different series products support different RS232 functions. Please refer to the actual product for detailed information.

- Baud rate: You can select proper baud rate.
- Data bit: You can select proper data bit. The value ranges from 5 to 8.
- Stop bit: There are three values: 1/1.5/2.
- Parity: there are five choices: none/odd/even/space mark.

System default setup is:

- Function: Console
- Baud rate:115200
- Data bit:8
- Stop bit:1
- Parity: None

After completing all the setups please click save button, system goes back to the previous menu.



Figure 4-216

4.10.5 Broadcast

It is to broadcast to the camera, or broadcast to a channel group.

Step 1 From Mani menu->Setting->System->Broadcast.

Enter the following interface. See Figure 4-217.

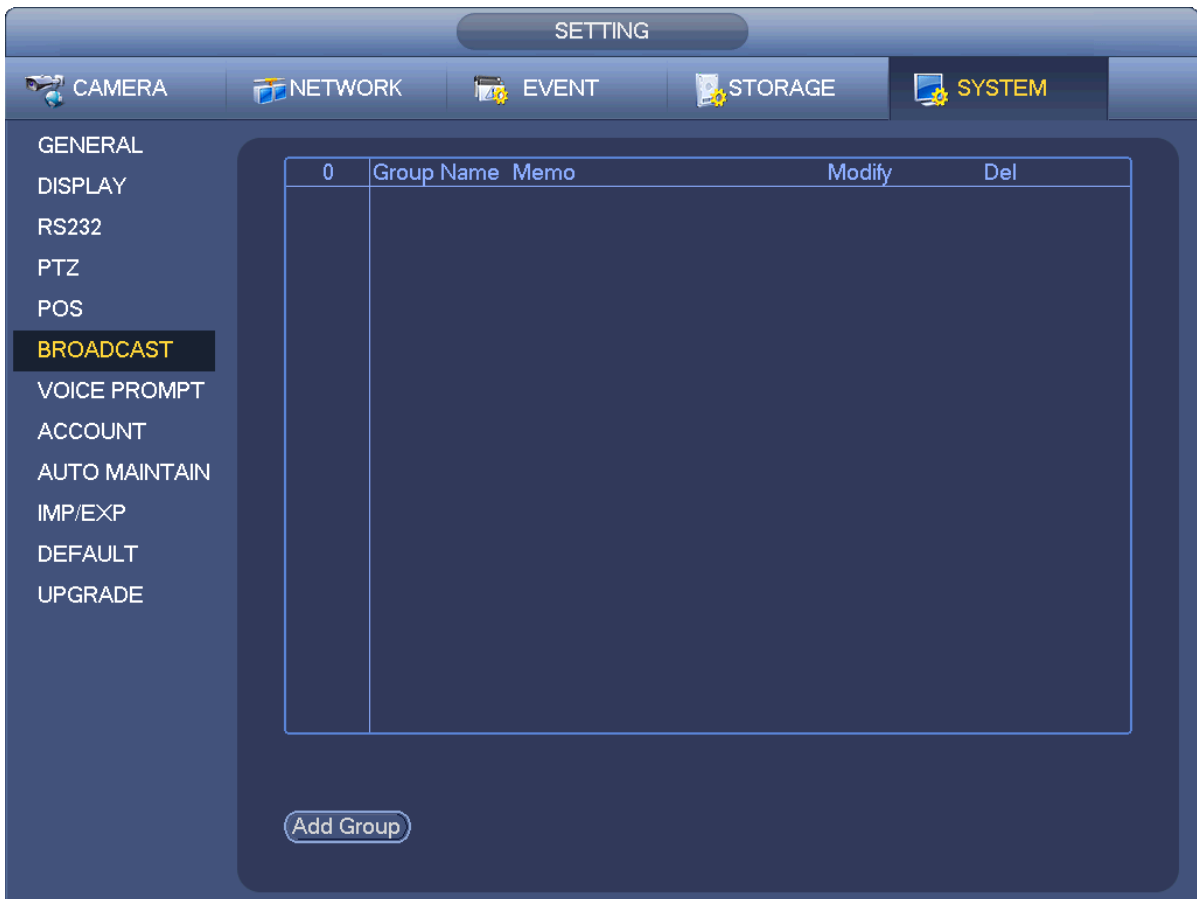

Figure 4-217

- Step 2 Click Add group.
Enter add group interface. See Figure 4-218.





Figure 4-218

- Step 3 Input group name and select one or more channels.

Step 4 Click Save button to complete broadcast group setup.

 **Note**

On the broadcast interface, click  to change group setup, click  to delete group.



After complete broadcast setup, on the preview interface and then click  on the navigation bar, device pops up broadcast dialogue box. Select a group name and then click  to begin broadcast. See Figure 4-219.



Figure 4-219

4.10.6 Security

4.10.6.1 IP Filter

IP filter interface is shown as in Figure 4-220. You can add IP in the following list. The list supports max 64 IP addresses. System supports valid address of IPv4 and IPv6. **Please note system needs to check the validity of all IPv6 addresses and implement optimization.**

After you enabled trusted sites function, only the IP listed below can access current NVR.

If you enable blocked sites function, the following listed IP addresses cannot access current NVR.

- Enable: Highlight the box here, you can check the trusted site function and blocked sites function. You cannot see these two modes if the Enable button is grey.
- Type: You can select trusted site and blacklist from the dropdown list. You can view the IP address on the following column.
- Start address/end address: Select one type from the dropdown list, you can input IP address in the start address and end address. Now you can click Add IP address or Add IP section to add.
 - a) For the newly added IP address, it is in enable status by default. Remove the before the item,

and then current item is not in the list.

- b) System max supports 64 items.
 - c) Address column supports IPv4 or IPv6 format. If it is IPv6 address, system can optimize it. For example, system can optimize aa:0000: 00: 00aa: 00aa: 00aa: 00aa as aa:: aa: aa: aa: aa: aa: aa.
 - d) System automatically removes space if there is any space before or after the newly added IP address.
 - e) System only checks start address if you add IP address. System check start address and end address if you add IP section and the end address shall be larger than the start address.
 - f) System may check newly added IP address exists or not. System does not add if input IP address does not exist.
- Delete: Click it to remove specified item.
 - Edit: Click it to edit start address and end address. See Figure 4-221. System can check the IP address validity after the edit operation and implement IPv6 optimization.
 - Default: Click it to restore default setup. In this case, the trusted sites and blocked sites are both null.

 **Note**

- If you enabled trusted sites, only the IP in the trusted sites list can access the device.
- If you enabled blocked sites, the IP in the blocked sites cannot access the device.
- System supports add MAC address.

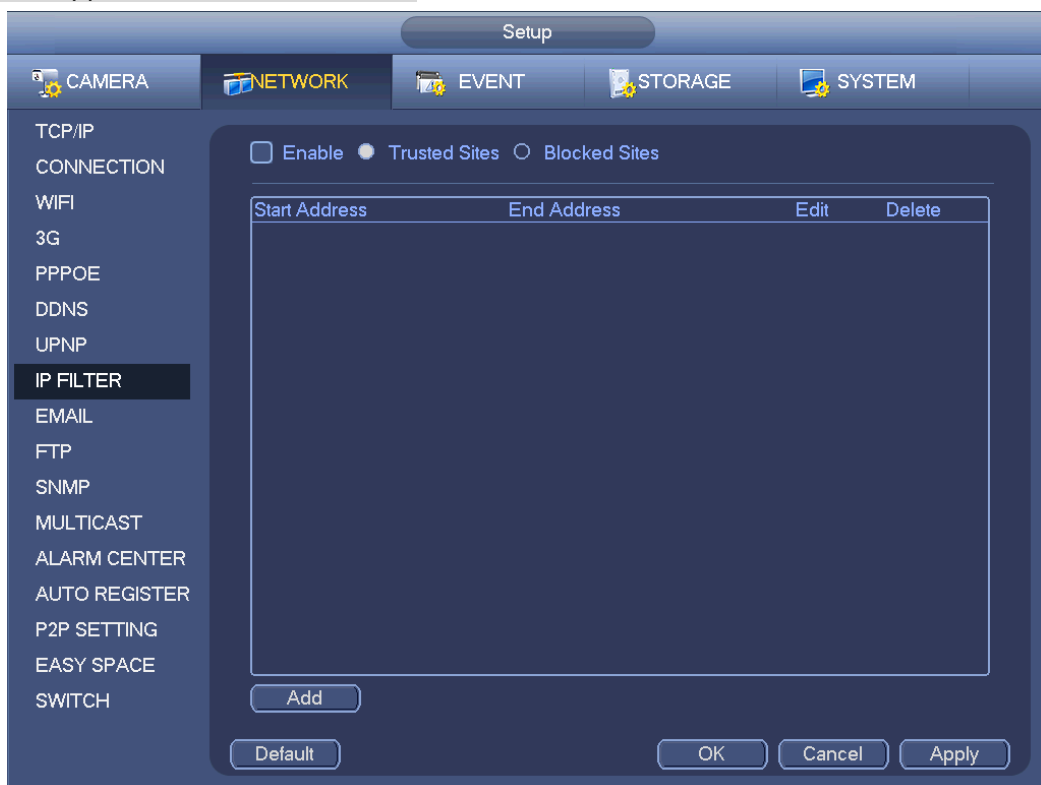

Figure 4-220

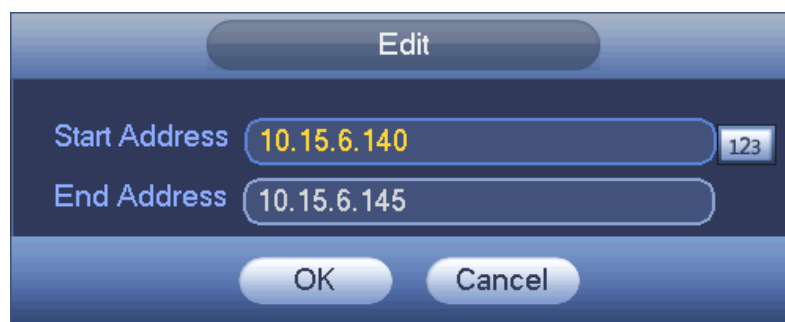

Figure 4-221

4.10.7 Auto Maintain

Here you can set auto-reboot time and auto-delete old files setup. You can set to delete the files for the specified days. See Figure 4-222.

You can select proper setup from dropdown list.

After all the setups please click save button, system goes back to the previous menu.

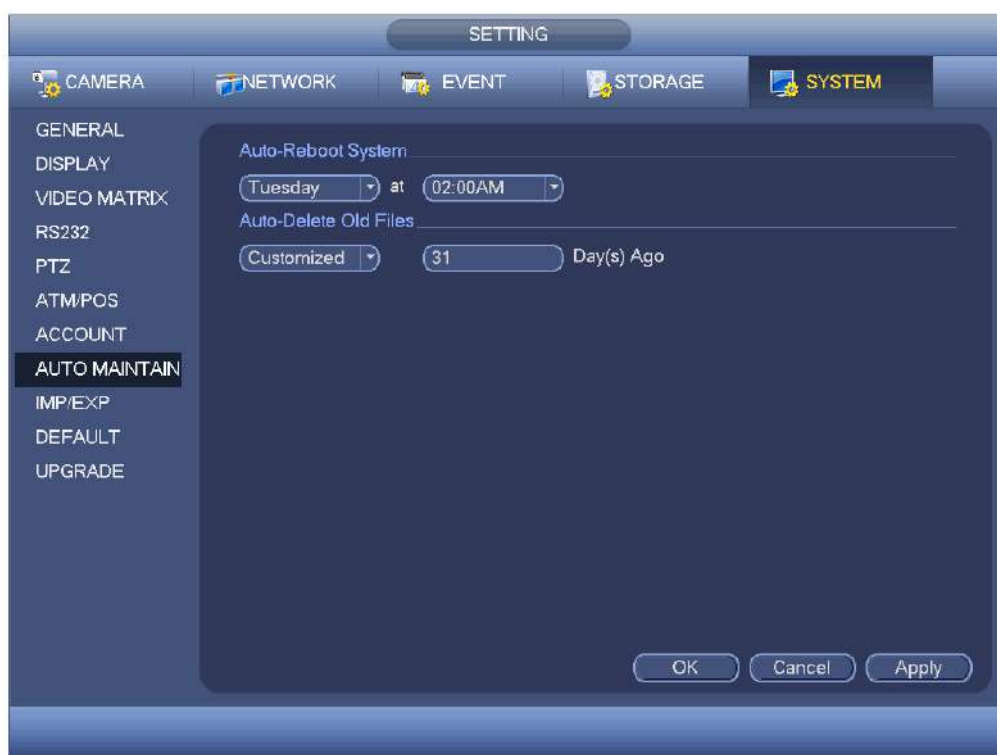

Figure 4-222

4.10.8 Backup

4.10.8.1 File Backup

In this interface, you can backup record file to the USB device.

- a) Connect USB burner, USB device or portable HDD and etc to the device.
- b) From Main menu->Backup, you can go to the Backup interface. See Figure 4-223

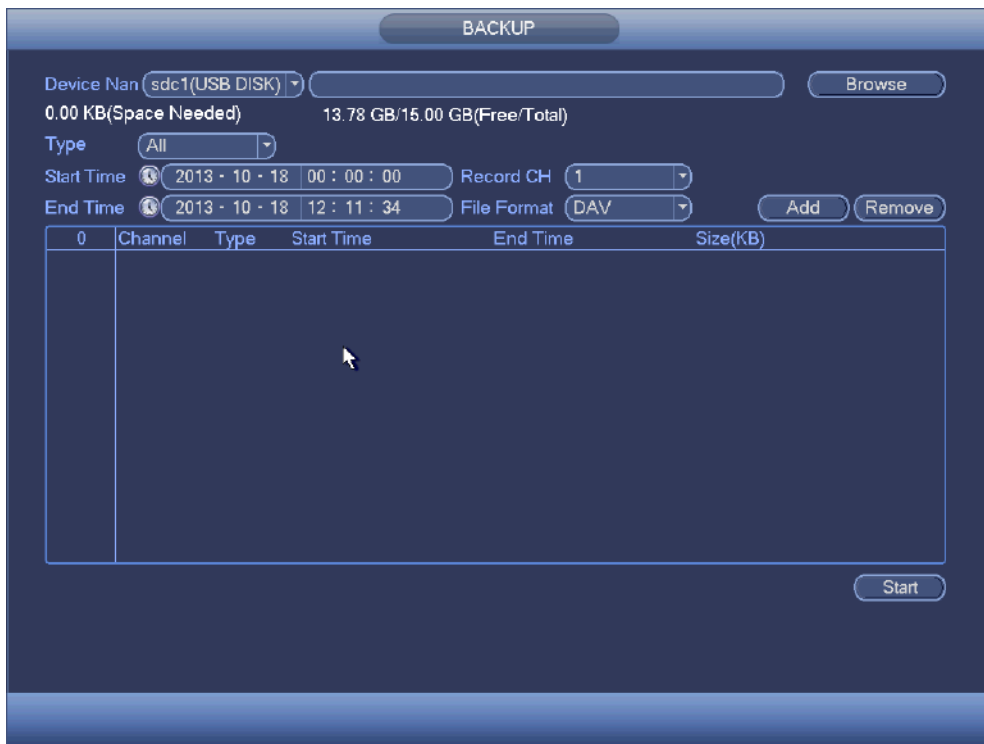

Figure 4-223

- c) Select backup device and then set channel, file start time and end time.
- d) Click add button, system begins search. All matched files are listed below. System automatically calculates the capacity needed and remained. See Figure 4-224.
- e) System only backup files with a before channel name. You can use Fn or cancel button to delete after file serial number.
- f) Click backup button, you can backup selected files. There is a process bar for you reference.
- g) When the system completes backup, you can see a dialogue box prompting successful backup.

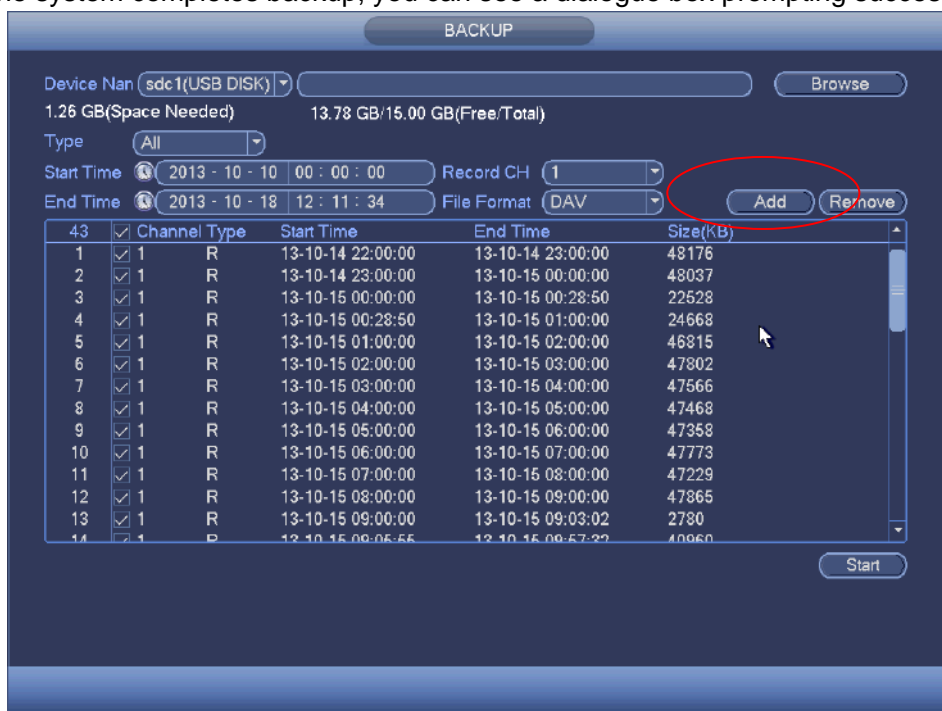

Figure 4-224

- h) Click backup button, system begins burning. At the same time, the backup button becomes stop button. You can view the remaining time and process bar at the left bottom.

 **Note**

- During backup process, you can click ESC to exit current interface for other operation (For some series product only). The system will not terminate backup process.
- The file name format usually is: Channel number+Record type+Time. In the file name, the YDM format is Y+M+D+H+M+S. File extension name is .dav.

4.10.8.2 Import/Export

This function allows you to copy current system configuration to other devices. It also supports import, create new folder, and delete folder and etc function.

From Main menu->Setting->System->Import/Export, you can see the configuration file backup interface is shown as below. See Figure 4-225.

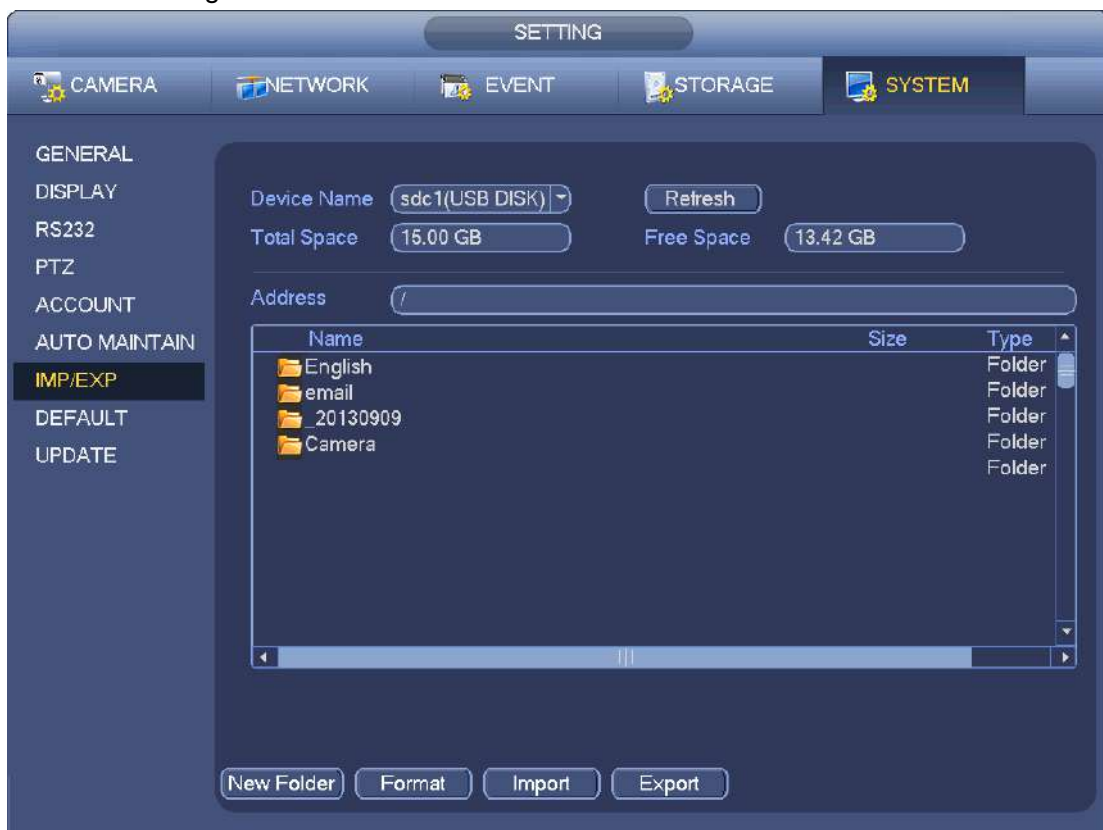

Figure 4-225

- Export: Please connect the peripheral device first and then go to the following interface. Click Export button, you can see there is a corresponding “Config_Time” folder. Double click the folder, you can view some backup files.
- Import: Here you can import the configuration files from the peripheral device to current device. You need to select a folder first. You can see a dialogue box asking you to select a folder if you are selecting a file. System pops up a dialogue box if there is no configuration file under current folder. After successfully import, system needs to reboot to activate new setup.
- Format: Click Format button, system pops up a dialogue box for you to confirm current operation. System begins format process after you click the OK button.

 **Note**

- System cannot open config backup interface again if there is backup operation in the process.
- System refreshes device when you go to the config backup every time and set current directory as the root directory of the peripheral device.
- If you go to the configuration backup interface first and then insert the peripheral device, please click Refresh button to see the newly added device.

4.10.8.3 Backup Log

a) From Main menu->Info->Log, the interface is shown as below. See Figure 4-226.



Figure 4-226

- b) Select log type and then set start time/end time, click Search button, you can see log time and event information. Click  to view detailed log information.
- c) Select log items you want to save and then click backup button, you can select a folder to save them. Click Start to backup and you can see the corresponding dialogue box after the process is finish.

4.10.8.4 USB Device Auto Pop-up

After you inserted the USB device, system can auto detect it and pop up the following dialogue box. It allows you to conveniently backup file, log, configuration or update system. See Figure 4-227. Please refer to chapter 4.10.8.1 file backup, chapter 4.10.8.3 backup log, chapter 4.10.8.2 import/export, and chapter 4.6.2 search for detailed information.



Figure 4-227

4.10.9 Default



Warning!

After you use default function, some your customized setup may lose forever! Please think twice before you begin the operation!

You can restore factory default setup to fix some problems when the device is running slowly. Configuration error occurred.

From Main menu->Setting->System->Default, you can go to the default interface. See Figure 4-228.

Check an item you want to restore default setup, or check the All to select all items.

Click OK or apply button, system pops up a dialogue box. Click OK to restore.



Figure 4-228

4.10.10 Upgrade

4.10.10.1 File Update

From Mani menu->Setting->Info->Update, you can go to the following interface. See Figure 4-229.

Step 1 Insert USB device that contain the upgrade file.

Step 2 Click Start button and then select the .bin file.

Step 3 You can see the corresponding dialogue box after the update process is complete.



Figure 4-229

4.10.10.2 Cloud Upgrade

When the NVR is online, you can use the online upgrade to update the firmware.

 **Note**

Make sure the NVR has properly connected to the network.

Version Detection

The version detection includes auto detection and manual detection. It displays current system version and application released date.

- Enable auto detection, NVR interactive with the cloud to detect there is new version available or not.
- Click manual detection, it is to view the latest new version on the cloud.
 - ✧ If current version is the latest one, there is prompt “It is the latest version”.
 - ✧ If NVR detects there is new version available, system displays new version information such as released date and corresponding release note.

Upgrade System

 **CAUTION**

During the upgrade process, make sure the network connection and power supplying are both OK.

Click Start to upgrade system.

4.10.10.2.1 Uboot

When NVR boots up, during the uboot process, NVR automatically detects there is USB device and there is upgrade file on the USB device or not. If the detection result is OK, NVR automatically begins upgrade.



CAUTION

- The USB device shall contain two files: u-boot.bin.img and update.img.
- The USB device shall connected to the USB port at the front panel. Otherwise, NVR cannot properly detect the file or upgrade.

4.11 Logout /Shutdown/Restart

From Mani menu->Operation->Shutdown, you can see an interface shown as in Figure 4-230.

- Shutdown: System shuts down and turns off power.
- Logout: Log out menu. You need to input password when you login the next time.
- Restart: reboot device.

If you shut down the device, there is a process bar for your reference, system waits for 3 seconds and then shut down (You cannot cancel).

Please note, sometimes you need to input the proper password to shut down the device.



Figure 4-230

5 Web Operation

5.1 General Introduction

If it is your first time to login the device, please initialize your device first. Refer to chapter 5.2 Device Initialization for detailed information.

The device web provides channel monitor menu tree, search, alarm setup, system setup, PTZ control and monitor window and etc.



Note

- Slight difference may be found on user interface. Please refer to the actual product for detailed information.
- Device supports various browsers such as Safari, Chrome and etc.
- Use ChromeApp to login the WEB if the Chrome version is 45 or higher. Go to the Chrome online store to download the ChromeApp installation package.

5.1.1 Preparation

Step 1 PC and NVR connection is OK.

Step 2 Set PC IP address, NVR IP address, subnet mask and gateway.

- Set the IP address of the same section for the PC and NVR. Input corresponding gateway and subnet mask if there are routers.)
- The device default IP address is 192.168.1.108.

Step 3 Check the PC and device connection is OK or not. Refer to the following two ways to check the network connection is OK or not. When the PC and device network connection is OK, login the WEB via the PC.

- On PC, use order ping `***.***.***.***`(NVR IP address) to check connection is OK or not. Login Usually the TTL value is 255.
- Login the device local menu, from setting->Network->Network test and then input PC IP address. Check the connection is OK or not.

Step 4 Login the WEB. Refer to chapter 5.9 Login for detailed information.

5.2 Device Initialization

If it is your first time to use the device, please set a login password of **admin** (system default user).



Note

For your device safety, please keep your login password of **admin** well after the initialization steps, and change the password regularly.

Please follow the steps listed below.

Step 1 Open the IE and then input the NVR IP address in the address column.

Step 2 Click Enter button.

Device displays device initialization interface. See Figure 5-1.

Figure 5-1

Step 3 Set login password of **admin**.

- User name: The default user name is **admin**.
- Password/confirm password: The password ranges from 8 to 32 digitals. It can contain letters, numbers and special characters (excluding “'”, “””, “;”, “:”, “&”). The password shall contain at least two categories. Usually we recommend the strong password.



WARNING

STRONG PASSWORD RECOMMENDED-For your device own safety, please create a strong password of your own choosing. We also recommend you change your password periodically especially in the high security system.

Step 4 Click Next, device goes to the following interface. See Figure 5-2.

Figure 5-2

Step 5 Set security questions.

 **Note**

- After setting the security questions here, you can use the email you input here or answer the security questions to reset **admin** password Refer to chapter 5.3 Reset password for detailed information.
- Cancel the email or security questions box and then click Next button to skip this step.
- Email: Input an email address for reset password purpose. Scan the QR code to reset the password, you need to receive the security code by the email. Input the security code to reset the password of **admin**. In case you have not input email address here or you need to update the email information, please go to the main Setup->System->Account to set. Refer to chapter 5.10.5.7 for detailed information.
- Security question: Set security questions and corresponding answers. Properly answer the questions to reset **admin** password. In case you have not input security question here or you need to update the security question information, please go to the main menu->Setting->System->Account->Security question to set. Refer to chapter 4.10.1.3 Security question for detailed information.

 **Note**

If you want to reset password by answering security questions, please go to the local menu interface.

Step 6 Click OK to complete the device initialization setup. See Figure 5-3.

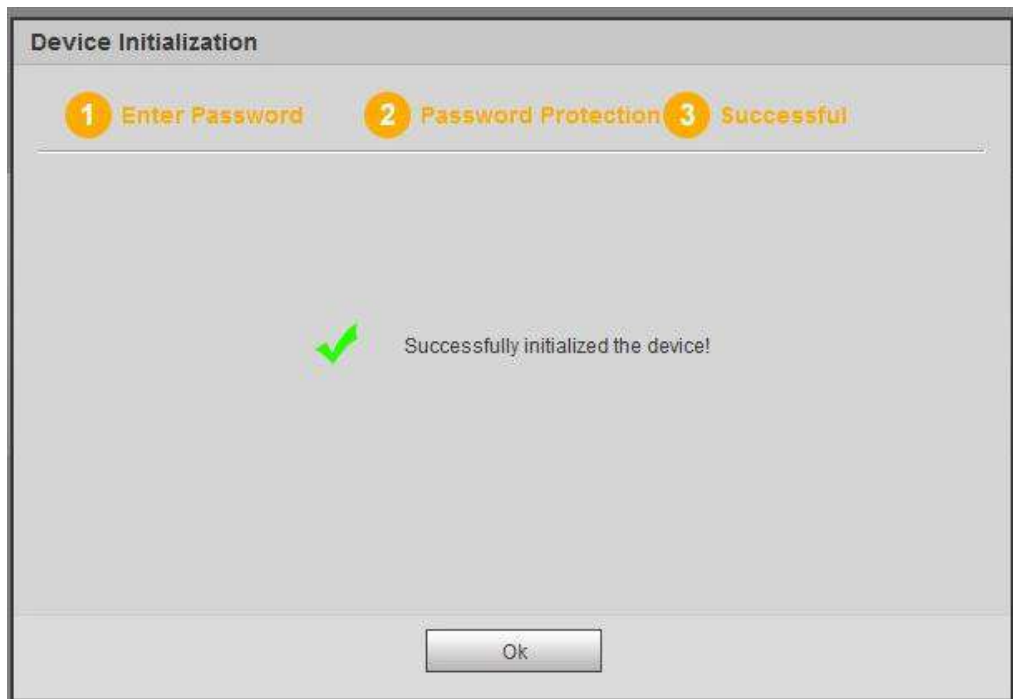

Figure 5-3

5.2.1 Log in

Open the IE and then input the NVR IP address in the address column.

For example, if your NVR IP address is 192.168.1.108, then please input http:// 192.168.1.108 in IE address column. See Figure 5-4.

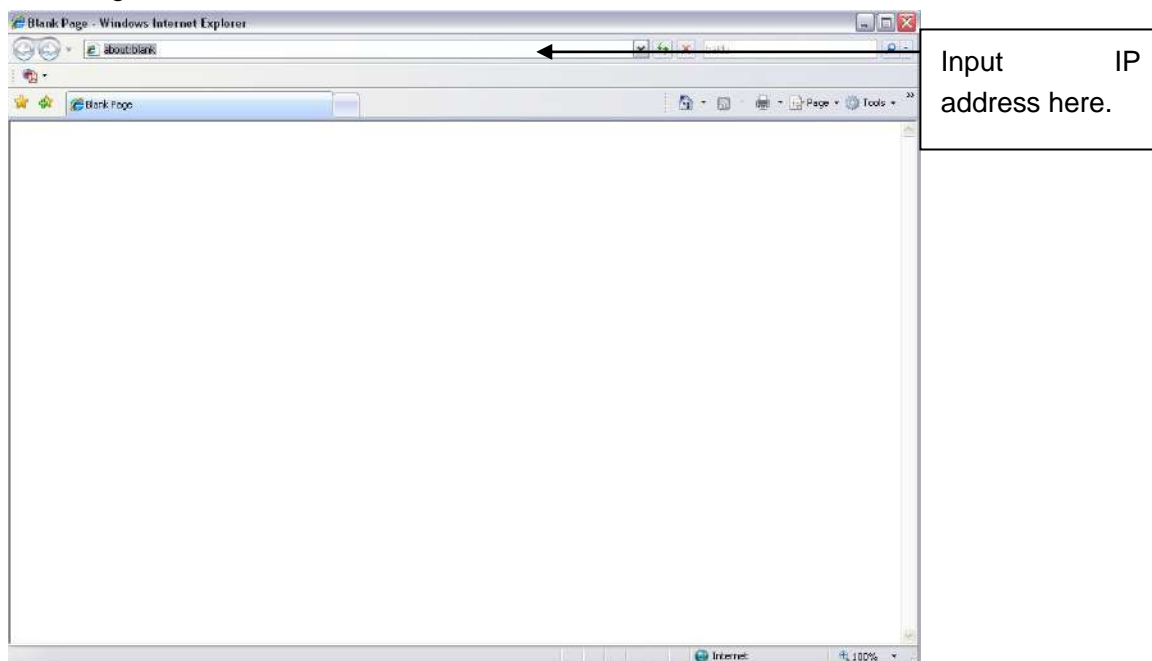

Figure 5-4

System pops up warning information to ask you whether install Web plug-in or not. Please click yes button.

After installation, the interface is shown as below. See Figure 5-5.



Figure 5-5

Please input your user name and password.

Factory default user name is **admin** and password is what you set in chapter 5.2 Device initialization.

5.3 Reset Password

If you forgot **admin** password, you can reset the password by email or by answering the security questions (local menu only).

Please follow the steps listed below.

Step 1 Go to the device login interface. See Figure 5-3.



Figure 5-6

Step 2 Click **Forgot password**, enter the following interface. See Figure 5-7.

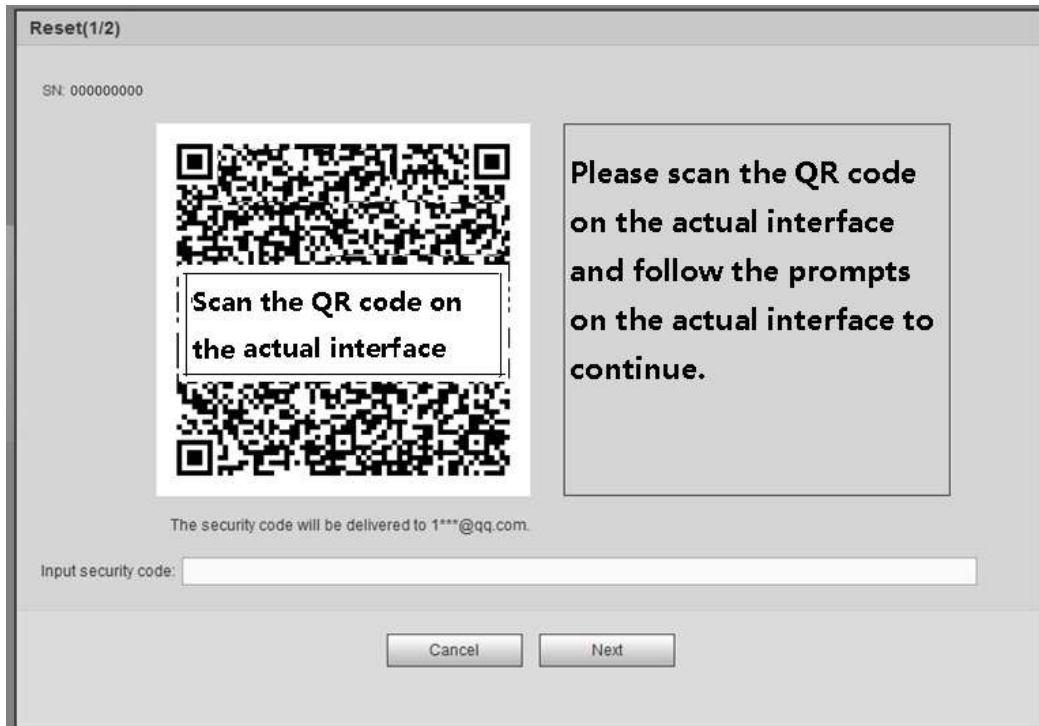

Figure 5-7

Step 3 Follow the prompts on the interface and then scan the QR code to get the security code.



WARNING

- ✧ For the same QR code, max scan twice to get two security codes. Refresh the QR code if you want to get security code again.
- ✧ The security code on you email is only valid for 24 hours.
- ✧ After five times security code failure, the **admin** account will be locked for 5 minutes.

Step 4 Input the security code on the email and then click Next button.

Step 5 Input new password and then confirm.



WARNING

STRONG PASSWORD RECOMMENDED-For your device own safety, please create a strong password of your own choosing. The password shall be at least 8-digit containing at least two types of the following categories: letters, numbers and symbols. We also recommend you change your password periodically especially in the high security system.

Step 6 Click OK button to complete the setup.

5.4 LAN Mode

For the LAN mode, after you logged in, you can see the main window. See Figure 5-13.

This main window can be divided into the following sections.

- Section 1: there are six function buttons: Live (chapter 0), setup (chapter 5.10), info (Chapter 5.11), playback (chapter 5.12), alarm (chapter 5.13), and logout (chapter 5.15).

- Section 2: There are monitor channels successfully connected to the NVR. Please refer to Figure 5-8 for main stream and extra stream switch information.

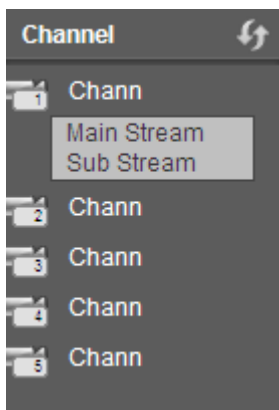

Figure 5-8

- Section 3: Open all. Open all button is to enable/disable all-channel real-time monitor. Here you can select main stream/sub stream too. See Figure 5-9.

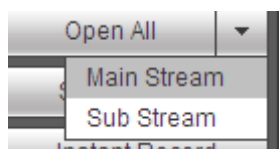

Figure 5-9

- Section 4: Start Talk button.

You can click this button to enable audio talk. Click 【▼】 to select bidirectional talk mode. There are four options: DEFAULT, G711a, G711u and PCM. See Figure 5-10.

After you enable the bidirectional talk, the Start talk button becomes End Talk button and it becomes yellow. Please note, if audio input port from the device to the client-end is using the first channel audio input port. During the bidirectional talk process, system will not encode the audio data from the 1-channel.

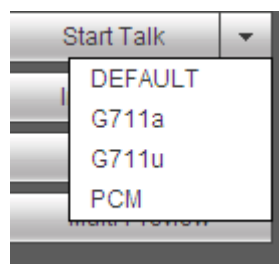

Figure 5-10

- Section 5: Instant record button. Click it, the button becomes yellow and system begins manual record. See Figure 5-11. Click it again, system restores previous record mode.

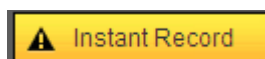

Figure 5-11

- Section 6: Local play button.

The Web can playback the saved (Extension name is dav) files in the PC-end.

Click local play button, system pops up the following interface for you to select local play file. See Figure

5-12.



Figure 5-12

- Section 7: Zero-channel encoding. Please refer to chapter 5.8 for detailed information.
- Section 8: PTZ operation panel. Please refer to chapter 5.6 for detailed information.
- Section 9: Image setup and alarm setup. Please refer to chapter 5.7 for detailed information.
- Section 10: From the left to the right ,you can see video quality/fluency/ full screen/1-window/4-window/6-window/8-window/9-window/13-window/16-window/20-window/25-window/36-window.. You can set video fluency and real-time feature priority.

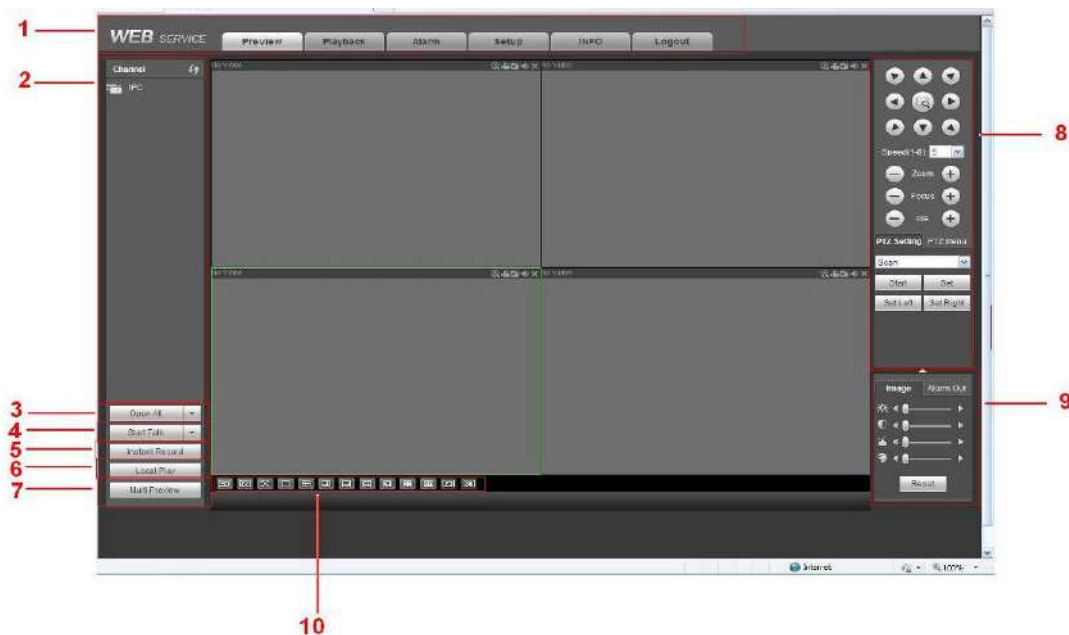

Figure 5-13

5.5 Real-time Monitor

In section 2, left click the channel name you want to view, you can see the corresponding video in current window.

On the top left corner, you can view device IP(172.11.10.11), channel number(1), network monitor bit stream(2202Kbps) and stream type(M=main stream, S=sub stream). See Figure 5-14.

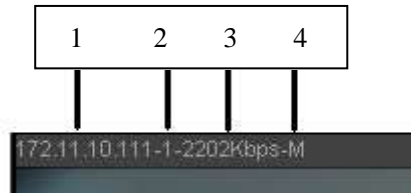

Figure 5-14

On the top right corner, there are six unction buttons. See Figure 5-15.

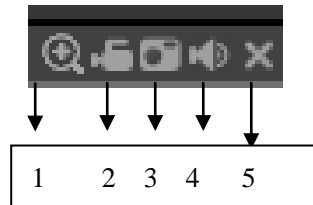

Figure 5-15

- 1: Digital zoom: Click this button and then left drag the mouse in the zone to zoom in. right click mouse system restores original status.
- 2: Local record. When you click local record button, the system begins recording and this button becomes highlighted. You can go to system folder RecordDownload to view the recorded file.
- 3: Snapshot picture. You can snapshot important video. All images are memorized in system client folder PictureDownload (default).
- 4: Audio :Turn on or off audio.(It has no relationship with system audio setup)
- 5: Close video.

5.6 PTZ

Before PTZ operation, please make sure you have properly set PTZ protocol. (Please refer to chapter 5.10.5.4).

There are eight direction keys. In the middle of the eight direction keys, there is a 3D intelligent positioning key.

Click 3D intelligent positioning key, system goes back to the single screen mode. Drag the mouse in the screen to adjust section size. It can realize PTZ automatically.

Please refer to the following sheet for PTZ setup information.

Parameter	Function
Scan	<ul style="list-style-type: none"> ● Select Scan from the dropdown list. ● Click Set button, you can set scan left and right limit. ● Use direction buttons to move the camera to you desired location and then click left limit button. Then move the camera again and then click right limit button to set a right limit.
Preset	<ul style="list-style-type: none"> ● Select Preset from the dropdown list. ● Turn the camera to the corresponding position and Input the preset value. Click Add button to add a preset.

Parameter	Function
Tour	<ul style="list-style-type: none"> ● Select Tour from the dropdown list. ● Input preset value in the column. Click Add preset button, you have added one preset in the tour. ● Repeat the above procedures you can add more presets in one tour. ● Or you can click delete preset button to remove one preset from the tour.
Pattern	<ul style="list-style-type: none"> ● Select Pattern from the dropdown list. ● You can input pattern value and then click Start button to begin PTZ movement such as zoom, focus, iris, direction and etc. Then you can click Add button to set one pattern.
Aux	<ul style="list-style-type: none"> ● Please input the corresponding aux value here. ● You can select one option and then click AUX on or AUX off button.
Light and wiper	You can turn on or turn off the light/wiper.

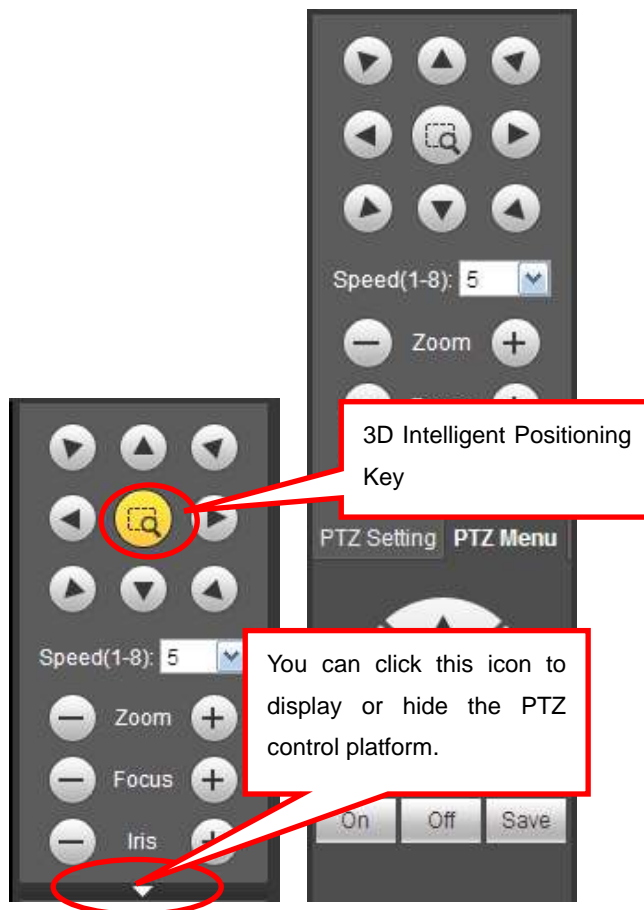

Figure 5-16

5.7 Image/Alarm-out

Select one monitor channel video and then click Image button in section 9, the interface is shown as Figure 5-17.

5.7.1 Image

Here you can adjust its brightness, contrast, hue and saturation. (Current channel border becomes green).

Or you can click Reset button to restore system default setup.

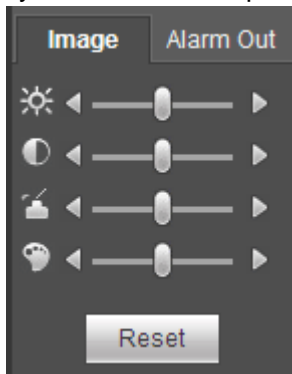

Figure 5-17

5.7.2 Alarm output

Here you can enable or disable the alarm signal of the corresponding port. See Figure 5-18.



Figure 5-18

5.8 Zero-channel Encode

Select a window and then click zero-channel encode button, the interface is shown as below. See Figure 5-19.

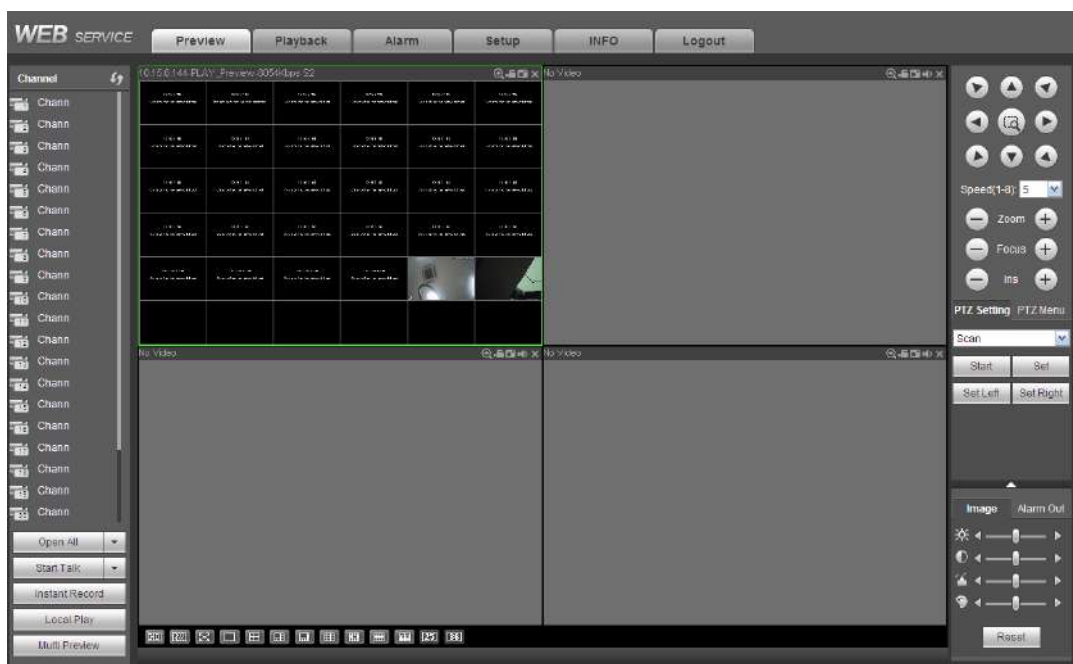

Figure 5-19

5.9 WAN Login

In WAN mode, after you logged in, the interface is shown as below. See Figure 5-20.



Figure 5-20

Please refer to the following contents for LAN and WAN login difference.

- 1) In the WAN mode, system opens the main stream of the first channel to monitor by default. The open/close button on the left pane is null.
- 2) You can select different channels and different monitor modes at the bottom of the interface. See

Figure 5-21.

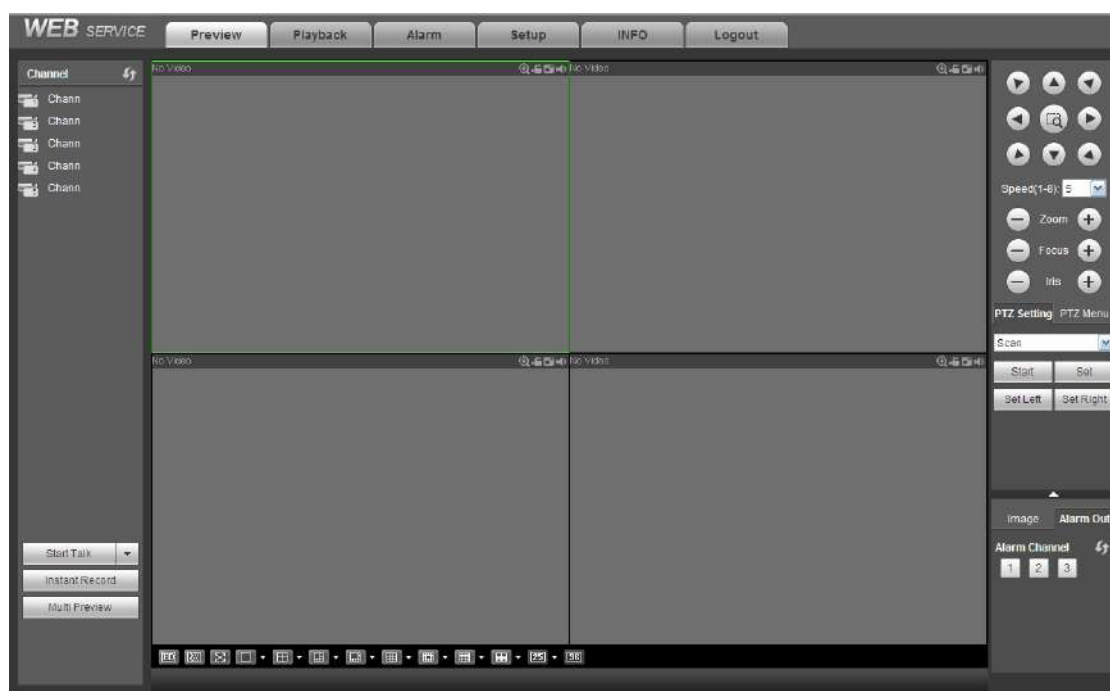

Figure 5-21

Important

The window display mode and the channel number are by default. For example, for the 16-channel, the max window split mode is 16.

3) Multiple-channel monitor, system adopts extra stream to monitor by default. Double click one channel, system switches to single channel and system uses main stream to monitor. You can view there are two icons at the left top corner of the channel number for you reference. M stands for main stream. S stands for sub stream (extra stream).

4) If you login via the WAN mode, system does not support alarm activation to open the video function in the Alarm setup interface.

Important

- For multiple-channel monitor mode, system adopts extra stream to monitor by default. You cannot modify manually. All channels are trying to synchronize. Please note the synchronization effect still depends on your network environments.
- For bandwidth consideration, system cannot support monitor and playback at the same time. System auto closes monitor or playback interface when you are searching setup in the configuration interface. It is to enhance search speed.

5.10 Setup

5.10.1 Camera

5.10.1.1 Registration

5.10.1.1.1 Registration

From Main menu->Setting->Camera->Registration->Registration, you can see the following interface. See Figure 5-22.

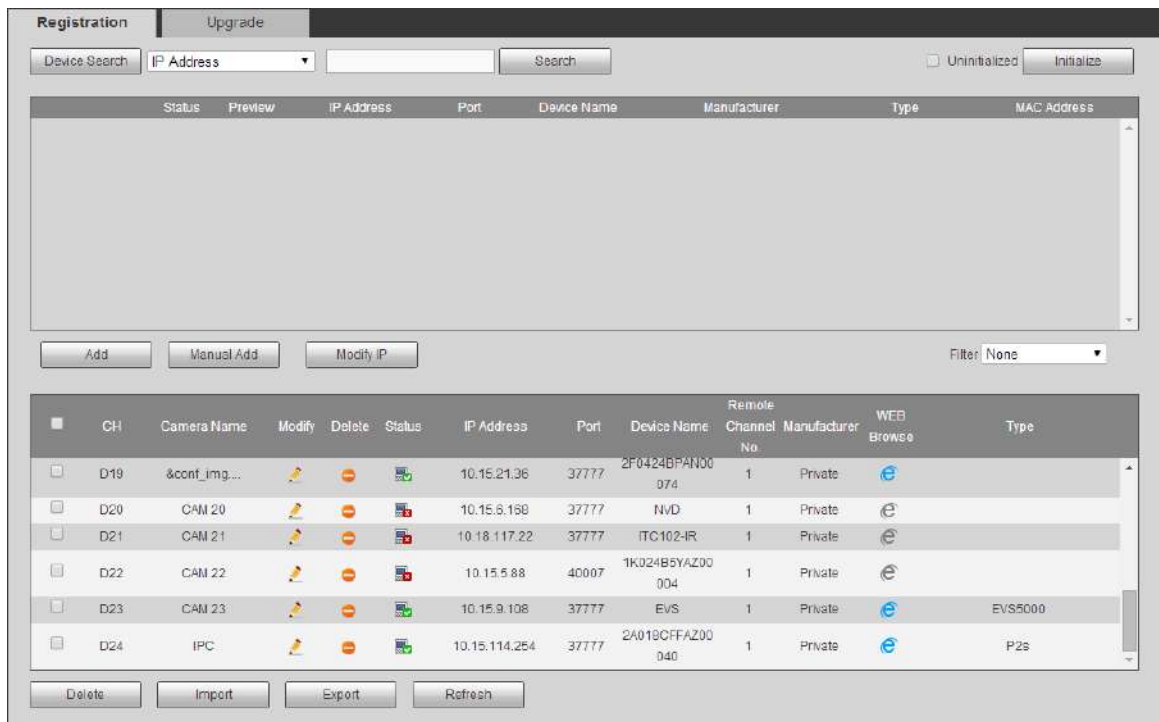







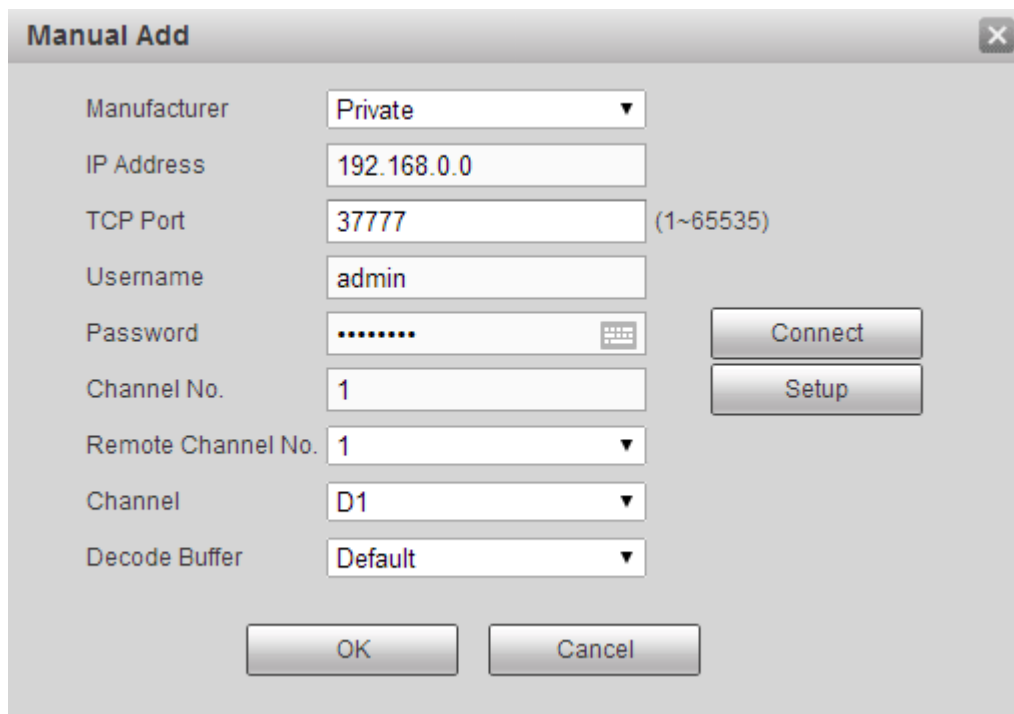

Figure 5-22

Please refer to the following sheet for parameter information.

Parameter	Function
IP Address	Select IP address or the MAC address from the dropdown list and then input the corresponding information, click Search button to view the results.
Search	Click Search button, you can view the searched device information on the list. It includes device IP address, port, device name, manufacturer and type.
Uninitialized	Click to search the initialized devices. Select an uninitialized device and then click the Initialize button to set the account.
Preview	Click  to view the preview video of the remote device.
State	It is to display the device has been initialized or not. That is to say, the remote device has set the initial account information or not.  means the remote device has initialized,  means the remote device has not been initialized.
Add	Select a device in the list and then click Add button, system can connect the device automatically and add it to the Added device list. Or you can double click one item in the list to add a device.
Modify	Click  or any device in the Added device list, you can change the corresponding channel setup.
Delete	Click  , you can delete the remote connection of the corresponding channel.

Parameter	Function
Type	There are two connection types. You can use the network to connect to the camera or use the WIFI. The  means current network camera connection mode is general; the  means current network camera mode is hotspot.
Delete	Select a device in the Added device list and then click Delete button, system can disconnect the device and remove it from the Added device list.
Manual Add	Click it, the interface is shown as in Figure 5-23. Here you can add network camera manually. You can select a channel from the dropdown list (Here only shows disconnection channel.)



The screenshot shows a 'Manual Add' dialog box with the following fields and values:





- Manufacturer: Private
- IP Address: 192.168.0.0
- TCP Port: 37777 (range: 1~65535)
- Username: admin
- Password: masked with dots
- Channel No.: 1
- Remote Channel No.: 1
- Channel: D1
- Decode Buffer: Default

Buttons: Connect, Setup, OK, Cancel

Figure 5-23

Please refer to the following sheet for parameter information.

Parameter	Function
Manufacturer	Please select from the dropdown list.  Note Different series products may support different manufacturers, please refer to the actual product.
IP address	Input remote device IP address.

Parameter	Function
RTSP port	Input RTSP port of the remote device. The default setup is 554.  Note Skip this item if the manufacture is private or customize.
HTTP port	Input HTTP port of the remote device. The default setup is 80.  Note Skip this item if the manufacture is private or customize.
TCP port	Input TCP port of the remote device. The default setup is 37777.
User name/password	The user name and password to login the remote device.
Channel No.	Input channel amount or click the Connect button to get the channel amount of the remote device.  Note We recommend click Connect button to get remote device channel amount, the manual add operation may result in failure if the input channel amount is not right.
Remote channel No.	After getting the remote device channel amount, click Setup to select a channel.  Note Click to select one or more remote channel numbers here.
Channel	The local channel number you want to add. One channel name has corresponding one channel number.
Decode buffer	There are three item: realtime, local, fluent.
Service type	There are four items: auto/TCP/UDP/MULTICAST(ONVIF device only)  Note <ul style="list-style-type: none"> The default connection mode is TCP if the connection protocol is private. There are three items:TCP/UDP/MULTICAST if the connection protocol is ONVIF. There are two items: TCP/UDP if the connection protocol is from the third-party.

Change IP

On the searched devices list, check one or more device(s) at the same time. Click Modify IP button, you can see the following interface. See Figure 5-24

Please refer to the following sheet for log parameter information.

Parameter	Function
DHCP	Check the box here, system can auto allocate the IP address. The IP address, subnet mask, default gateway are reference only.

Parameter	Function
Static	Check the box here, you can set IP address, subnet mask, default gateway manually.
IP address/subnet mask/default gateway	You can input corresponding information here.
User name/password	The account you login the remote device. Please input here to password verification to change the remote device password.
Incremental value	When you want to change several IP addresses, once you input the IP address of the first device, the IP address of the next device will increase accordingly. For example, when the incremental value is 1, if the IP address of the first device is 172.10.3.128, the IP address of the second device will auto be set as 172.10.3.129.

Note

For the static IP address, system will alert you if there is any IP conflict. If you are changing several IP addresses at the same time, system auto skip the conflicted IP and auto allocate again according to the incremental value you set.

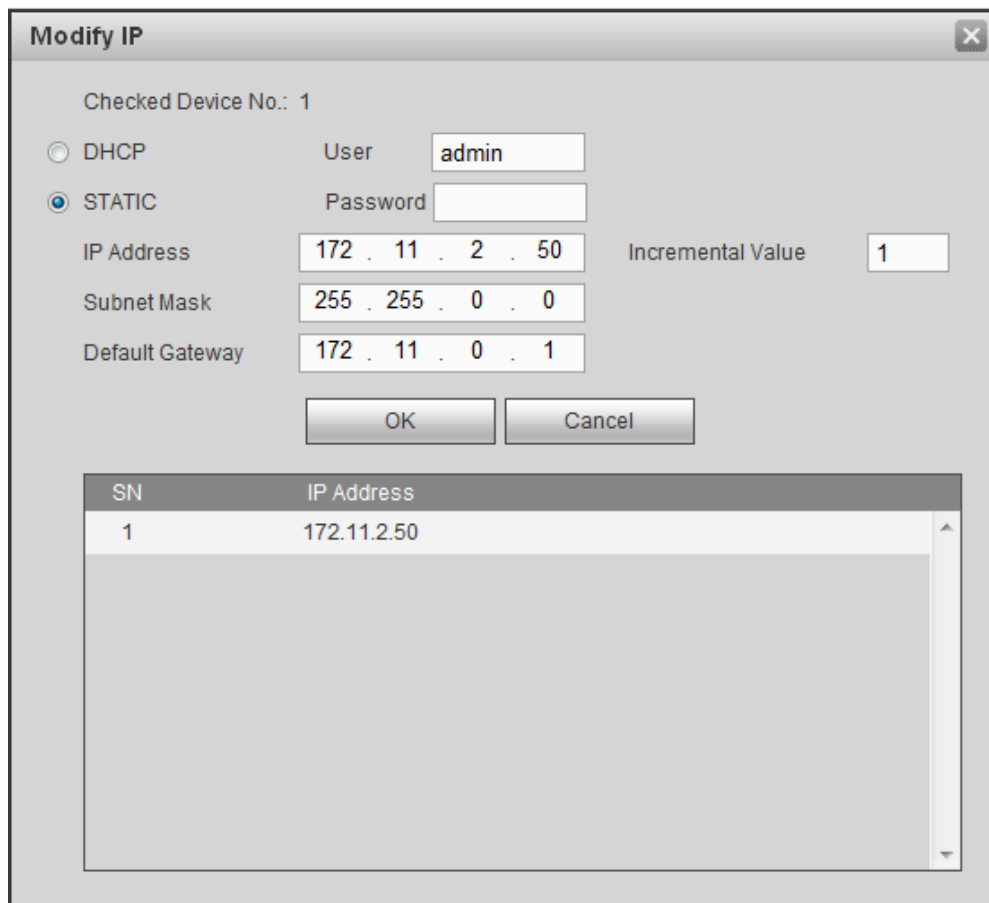

Figure 5-24

Export IP

You can export the list of the added devices to your local PC. Click Export button and then select the saved path. Click OK.

You can see “Backup completed ” prompt.

 **Note**

The export file extension name is .CVS. The file contains IP address, port, remote channel No. manufacturer, user name, password and etc.

Import IP

You can import the added device list to add the device conveniently.
Click Import button, and then select the import file.

 **Note**

If the imported IP is already in the added device list, system pops up dialogue box for you to confirm overwrite or not.

- Click OK button, the new IP setup can overwrite the old one.
- Click Cancel button, system adds the new IP setup.



Important

- You can edit the exported file. Please make sure the file format is the same. Otherwise you cannot import the file again!
- System does not support customized protocol import/export.
- The import/export function is for the devices of the same language.

5.10.1.1.2 IPC Upgrade

This interface is to upgrade network camera.

From Main menu->Setting->Camera->Registration->IPC upgrade, enter the following interface. See Figure 5-25.

Click Browse button to select upgrade file. Or you can use filter to select several network cameras at the same time.

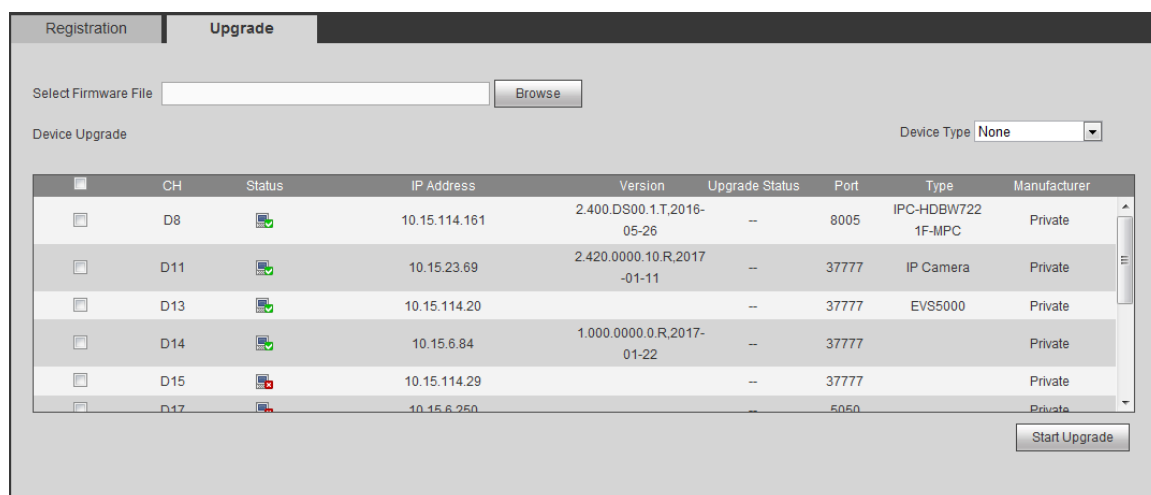

Figure 5-25

5.10.1.2 Image

 **Note**

Slight difference may be found since the connected network camera may not be same model.

Here you can view device property information. The setups become valid immediately after you set. See Figure 5-26.

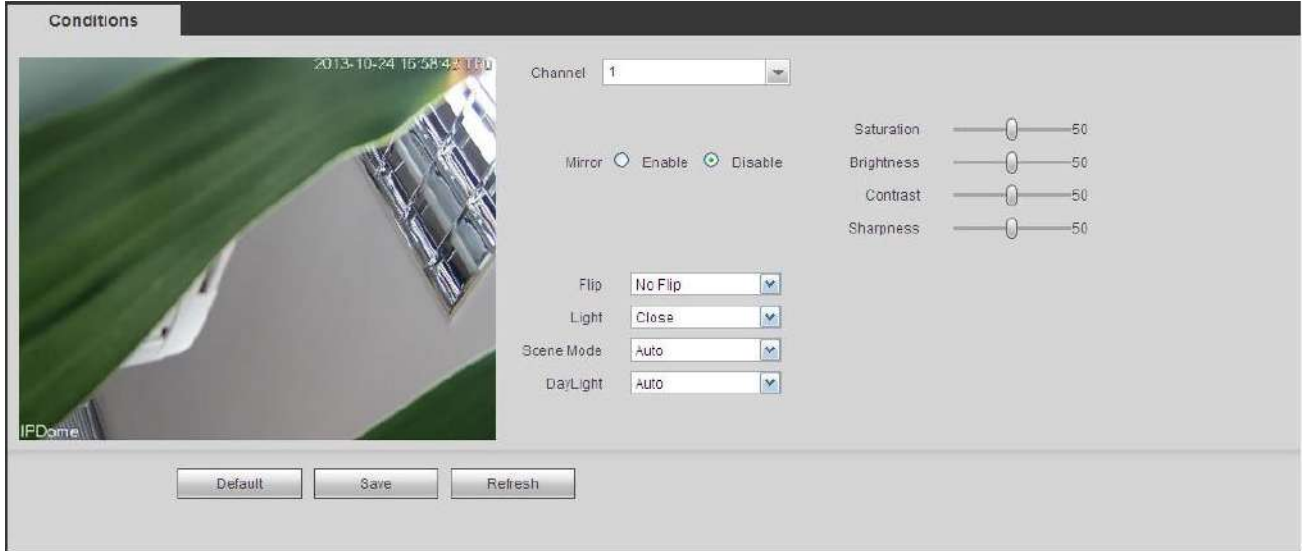

Figure 5-26

Please refer to the following sheet for detailed information.

Parameter	Function
Channel	Please select a channel from the dropdown list.
Period	It divides one day (24 hours) to two periods. You can set different hue, brightness, and contrast for different periods.
Hue	It is to adjust monitor video brightness and darkness level. The default value is 50. The bigger the value is, the large the contrast between the bright and dark section is and vice versa.
Brightness	It is to adjust monitor window brightness. The default value is 50. The larger the number is, the bright the video is. When you input the value here, the bright section and the dark section of the video will be adjusted accordingly. You can use this function when the whole video is too dark or too bright. Please note the video may become hazy if the value is too high. The value ranges from 0 to 100. The recommended value ranges from 40 to 60.
Contrast	It is to adjust monitor window contrast. The value ranges from 0 to 100. The default value is 50. The larger the number is, the higher the contrast is. You can use this function when the whole video bright is OK but the contrast is not proper. Please note the video may become hazy if the value is too low. If this value is too high, the dark section may lack brightness while the bright section may over exposure. The recommended value ranges from 40 to 60.

Saturation	<p>It is to adjust monitor window saturation. The value ranges from 0 to 100. The default value is 50.</p> <p>The larger the number is, the strong the color is. This value has no effect on the general brightness of the whole video. The video color may become too strong if the value is too high. For the grey part of the video, the distortion may occur if the white balance is not accurate. Please note the video may not be attractive if the value is too low. The recommended value ranges from 40 to 60.</p>	
Gain	<p>The gain adjust is to set the gain value. The smaller the value is, the low the noise is. But the brightness is also too low in the dark environments. It can enhance the video brightness if the value is high. But the video noise may become too clear.</p>	
White level	<p>It is to enhance video effect.</p>	
Color mode	<p>It includes several modes such as standard, color. You can select corresponding color mode here, you can see hue, brightness, and contrast and etc will adjust accordingly.</p>	
Auto Iris	<p>It is to enable/disable auto iris function.</p>	
Flip	<p>It is to switch video up and bottom limit. This function is disabled by default.</p>	
Mirror	<p>It is to switch video left and right limit. This function is disabled by default.</p>	
BLC Mode	BLC	<p>The device auto exposures according to the environments situation so that the darkest area of the video is cleared</p>
	WDR	<p>For the WDR scene, this function can lower the high bright section and enhance the brightness of the low bright section. So that you can view these two sections clearly at the same time.</p> <p>The value ranges from 1 to 100. When you switch the camera from no-WDR mode to the WDR mode, system may lose several seconds record video.</p>
	HLC	<p>After you enabled HLC function, the device can lower the brightness of the brightest section according to the HLC control level. It can reduce the area of the halo and lower the brightness of the whole video.</p>
	Off	<p>It is to disable the BLC function. Please note this function is disabled by default.</p>
Profile	<p>It is to set the white balance mode. It has effect on the general hue of the video. This function is on by default.</p> <p>You can select the different scene mode such as auto, sunny, cloudy, home, office, night, disable and etc to adjust the video to the best quality.</p> <ul style="list-style-type: none"> ● Auto: The auto white balance is on. System can auto compensate the color temperature to make sure the vide color is proper. ● Sunny: The threshold of the white balance is in the sunny mode. ● Night: The threshold of the white balance is in the night 	

	<p>mode.</p> <ul style="list-style-type: none"> ● Customized: You can set the gain of the red/blue channel. The value ranges from 0 to 100.
Day/Night	<p>It is to set device color and the B/W mode switch. The default setup is auto.</p> <ul style="list-style-type: none"> ● Color: Device outputs the color video. ● Auto: Device auto select to output the color or the B/W video according to the device feature (The general bright of the video or there is IR light or not.) ● B/W: The device outputs the black and white video. ● Sensor: It is to set when there is peripheral connected IR light.

5.10.1.3 Encode

5.10.1.3.1 Encode

The encode interface is shown as below. See Figure 5-27.

Figure 5-27

Please refer to the following sheet for detailed information.

Parameter	Function
Channel	Please select a channel from the dropdown list.
Video enable	Check the box here to enable extra stream video. This item is enabled by default.
Code stream type	<p>It includes main stream, motion stream and alarm stream. You can select different encode frame rates from different recorded events.</p> <p>System supports active control frame function (ACF). It allows you to record in different frame rates.</p> <p>For example, you can use high frame rate to record important events, record scheduled event in lower frame rate and it allows</p>

	you to set different frame rates for motion detection record and alarm record.
Compression	<p>Video encode mode.</p> <ul style="list-style-type: none"> ● H.264: Main Profile encode mode. ● H.264H: High Profile encode mode. ● H.264B: Baseline Profile encode mode. ● H.265: Main Profile encode mode. ● MJPEG: System needs high bit streams to guarantee video definition. Use the recommended max bit stream value to get the better video effect.
Smart Codec	<p>This function is to reduce bit streams.</p> <p> Note</p> <ul style="list-style-type: none"> ● Some series products support smart codec function. ● After changing smart code, please reboot network camera and some network camera functions (such as IVS, ROI, SVC, lobby mode and etc.) becomes null. Please think twice before the operation.
Resolution	The resolution here refers to the capability of the network camera.
Frame Rate	The video frame amount displayed in each second. The higher the frame rate is, the clearer and more fluent the video is. The frame rate may vary depending on the resolution.
Bit Rate	<ul style="list-style-type: none"> ● Main stream: You can set bit rate here to change video quality. The large the bit rate is, the better the quality is. Please refer to recommend bit rate for the detailed information. ● Extra stream: In CBR, the bit rate here is the max value. In dynamic video, system needs to low frame rate or video quality to guarantee the value. The value is null in VBR mode.
Bit rate type	<p>System supports two types: CBR and VBR.</p> <ul style="list-style-type: none"> ● Main stream: It is to set frame rate to change video quality. The higher the frame rate is, the better the video quality is. The referenced bit rate is the recommended value. ● Sub stream: In CBR mode, the bit stream is near the specified value. In VBR mode, the video quality changes according to the bit stream value. But its max value is near the specified value. Reference bit rate: The reference bit rate depends on the resolution and frame rate you set.
Reference bit rate	Recommended bit rate value according to the resolution and frame rate you have set.
I Frame	<p>Here you can set the P frame amount between two I frames. The value ranges from 1 to 150. Default value is 50.</p> <p>Recommended value is frame rate *2.</p>

Video/audio	You can enable or disable the video/audio. The main stream is enabled by default. After enable the audio function, the record file is composite file consisting of the video and audio. For the sub stream 1, please enable video first and then enable audio function.
Audio format	Set audio encode format.  Note Different series products support different audio encode mode. Please refer to the actual interface for detailed information.
Sampling rate	Audio sampling rate refers to the sampling amount within 1 second. The higher the value is, the better the audio is. The default setup is 8K.
Watermark enable	This function allows you to verify the video is tampered or not. Here you can select watermark bit stream, watermark mode and watermark character. Default character is DigitalCCTV. The max length is 85-digit. The character can only include number, character and underline.

5.10.1.3.2 Snapshot

The snapshot interface is shown as in Figure 5-28.

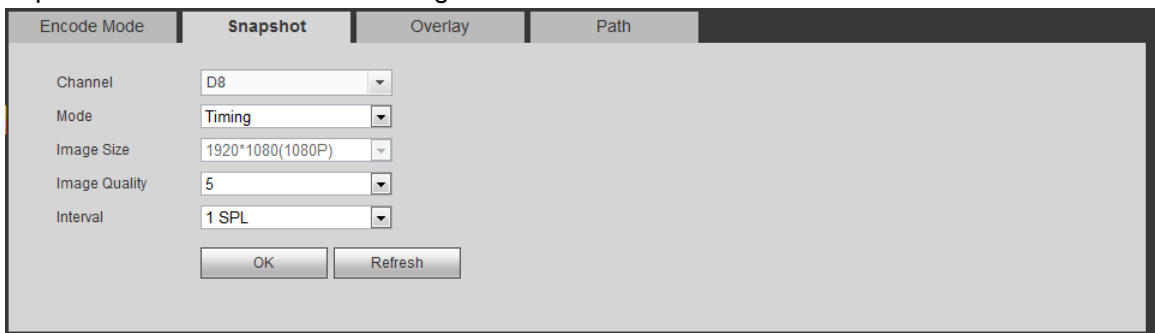

Figure 5-28

Please refer to the following sheet for detailed information.

Parameter	Function
Snapshot type	There are two modes: Regular (schedule) and Trigger. <ul style="list-style-type: none"> ● Regular snapshot is valid during the specified period you set. ● Trigger snapshot only is valid when motion detect alarm, tampering alarm or local activation alarm occurs.
Image size	It is the same with the resolution of the main stream.
Quality	It is to set the image quality. There are six levels.
Interval	It is to set snapshot frequency. The value ranges from 1s to 7s. Or you can set customized value. The max setup is 3600s/picture.
Copy	Click it; you can copy current channel setup to other channel(s).

5.10.1.3.3 Video Overlay

The video overlay interface is shown as in Figure 5-29.

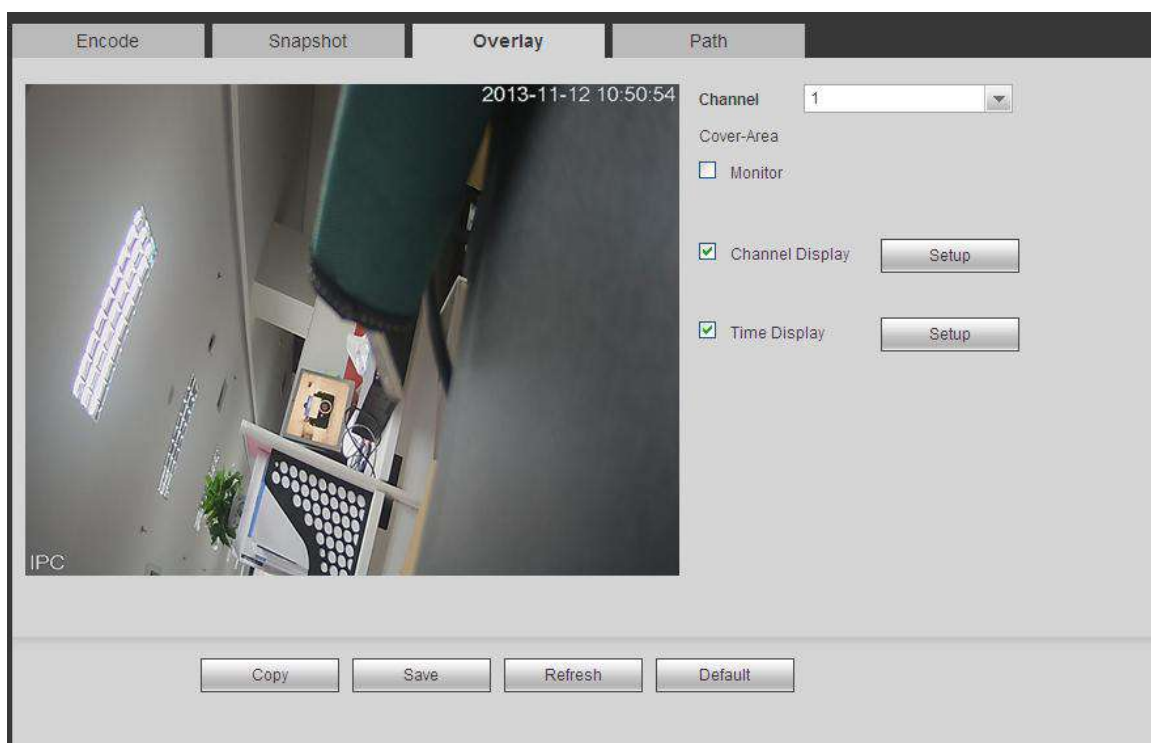



Figure 5-29

Please refer to the following sheet for detailed information.

Parameter	Function
Cover-area	Check Preview or Monitor first. Click Set button, you can privacy mask the specified video in the preview or monitor video. System max supports 4 privacy mask zones.
Time Title	You can enable this function so that system overlays time information in video window. You can use the mouse to drag the time title position. You can view time title on the live video of the WEB or the playback video.
Channel Title	You can enable this function so that system overlays channel information in video window. You can use the mouse to drag the channel title position. You can view channel title on the live video of the WEB or the playback video.

5.10.1.3.4 Path

The storage path interface is shown as in Figure 5-30.

Here you can set snap image saved path ( in the preview interface) and the record storage path ( in the preview interface). The default setup is C:\PictureDownload and C:\RecordDownload. Please click the Save button to save current setup.

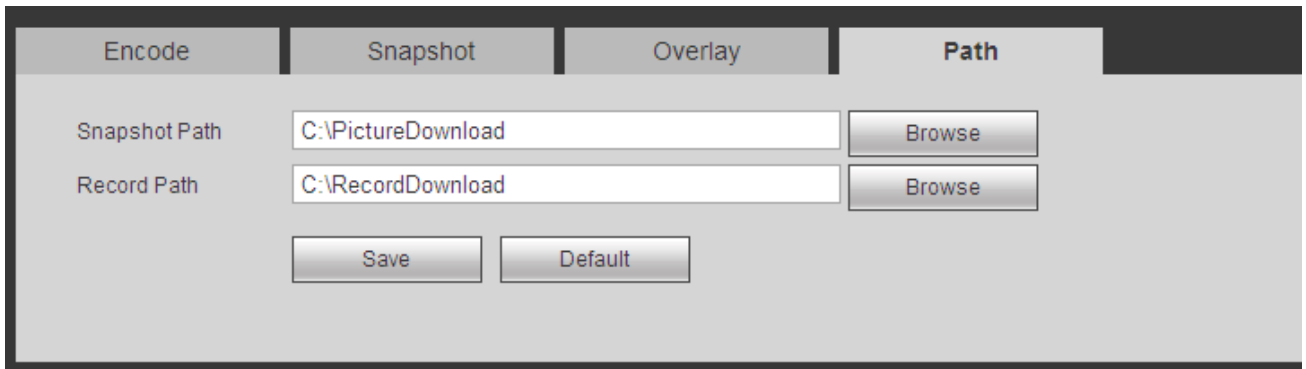

Figure 5-30

5.10.1.4 Channel Name

Here you can set channel name. See Figure 5-31.

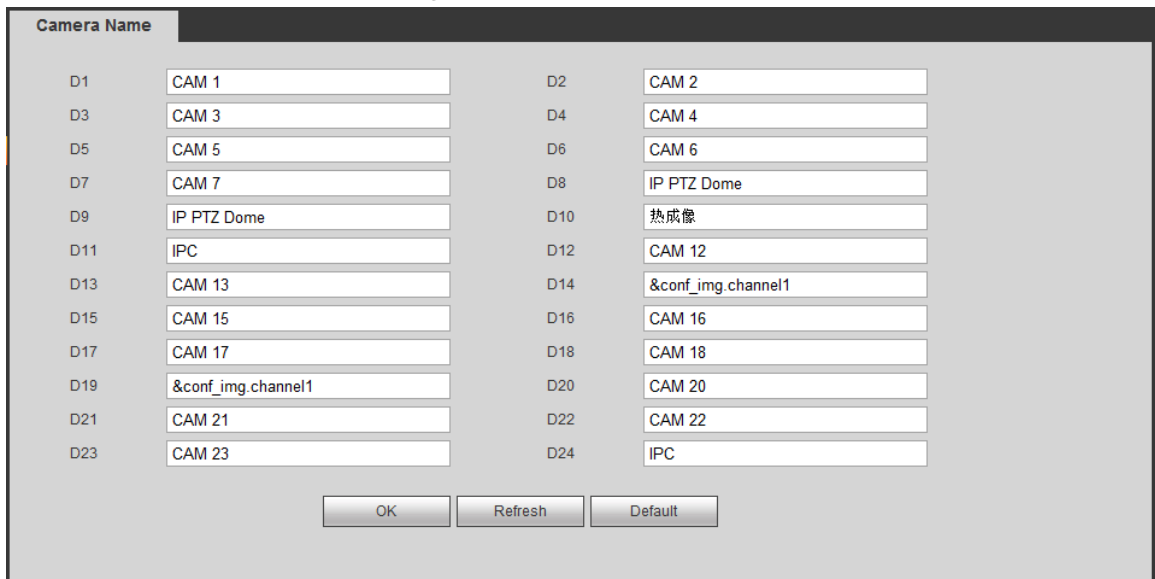

Figure 5-31

5.10.2 Network

5.10.2.1 TCP/IP

The TCP/IP interface is shown as in Figure 5-32.

The screenshot shows a configuration window with two tabs: 'TCP/IP' and 'P2P'. The 'TCP/IP' tab is active. The settings are as follows:

- Network Mode: Multi-address
- Default Card: Ethernet Card1
- Ethernet Card: Ethernet Card1 (with a 'Default Card' button next to it)
- Mode: STATIC, DHCP
- MAC Address: 88 . 38 . 44 . 62 . 11 . fe
- MTU: 1500
- IP Version: IPv4
- IP Address: 10 . 15 . 6 . 144
- Subnet Mask: 255 . 255 . 0 . 0
- Default Gateway: 10 . 15 . 0 . 1
- Preferred DNS: 10 . 1 . 2 . 80
- Alternate DNS: 10 . 1 . 2 . 81
- LAN Download

At the bottom, there are three buttons: 'Save', 'Refresh', and 'Default'.

Figure 5-32

Please refer to the following sheet for detailed information.

Parameter	Function
Mode	<p>There are two modes: static mode and the DHCP mode.</p> <ul style="list-style-type: none"> ● The IP/submask/gateway are null when you select the DHCP mode to auto search the IP. ● If you select the static mode, you need to set the IP/submask/gateway manually. ● If you select the DHCP mode, you can view the IP/submask/gateway from the DHCP. ● If you switch from the DHCP mode to the static mode, you need to reset the IP parameters. ● Besides, IP/submask/gateway and DHCP are read-only when the PPPoE dial is OK.
Mac Address	It is to display host Mac address.
IP Version	It is to select IP version. IPV4 or IPV6. You can access the IP address of these two versions.
IP Address	Please use the keyboard to input the corresponding number to modify the IP address and then set the corresponding subnet mask and the default gateway.
Preferred DNS	DNS IP address.
Alternate DNS	Alternate DNS IP address.
For the IP address of IPv6 version, default gateway, preferred DNS and alternate DNS, the input value shall be 128-digit. It shall not be left in blank.	
LAN load	System can process the downloaded data first if you enable this function. The download speed is 1.5X or 2.0X of the normal speed.

5.10.2.2 Connection

The connection interface is shown as in Figure 5-33.

CONNECTION

Max Connection: (0~128)

TCP Port: (1025~65535)

UDP Port: (1025~65535)

HTTP Port: (1~65535)

HTTPS Port: (128~65535)

RTSP Port: (128~65535)

RTSP Format: rtsp://<User Name>:<Password>@<IP Address>:<Port>/cam/realmonitor?channel=1&subtype=0
channel: Channel, 1-32; subtype: Code-Stream Type, Main Stream 0, Sub Stream 1.

Figure 5-33

Please refer to the following sheet for detailed information.

Parameter	Function
Max connection	The max client login amount (such as WEB, platform, cellphone and etc). The value ranges from 1 to 128(default).
TCP port	The default value is 37777. You can input the actual port number if necessary.
UDP port	The default value is 37778. You can input the actual port number if necessary.
HTTP port	The default value is 80. You can input the actual port number if necessary.
HTTPS	The default value is 443. You can input the actual port number if necessary.
RTSP port	The default value is 554.

5.10.2.3 WIFI AP

Please note this function is for some series only.

5.10.2.3.1 General Setup

The WIFI AP interface is shown as in Figure 5-34. Here you can set WIFI hotspot, so that the network camera can use the hotspot to connect to the network.

Figure 5-34

Please refer to the following sheet for detailed information.

Parameter	Function
SSID	It is to set SSID name. You can use this name to search the device.
Password	It is to set SSID password. You can use this password to connect to the network.
Security	Select authentication from the dropdown list.
Start IP/End IP	Input start IP and end IP. The NVR can allocate the IP address in the range you specified here.
WPS	Click WPS button to enable WPS function. After the network camera enabled this function, it can automatically connect to the network.
Remote device	In the list, you can view the network camera(s) that connected to the NVR. It includes signal intensity, IP, MAC address, bit rate, channel number, type, status and etc.

5.10.2.3.2 Advanced

Click Advanced button, the interface is shown as below. See Figure 5-35.

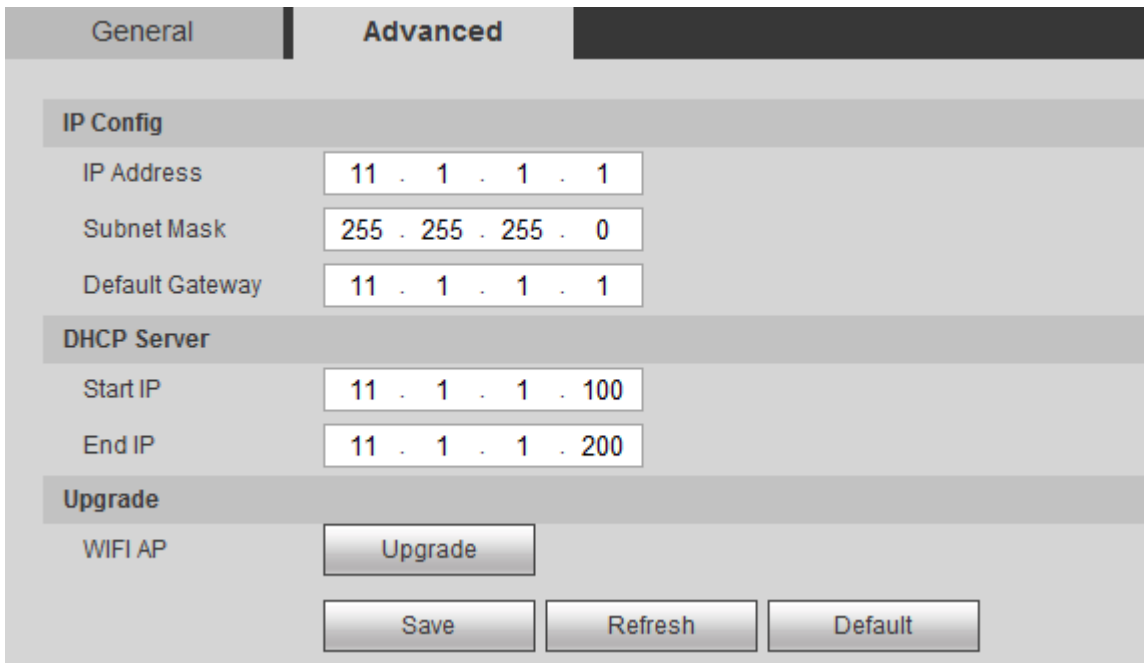

Figure 5-35

Please refer to the following sheet for detailed information.

Parameter	Function
IPv4 address	Input WIFI AP IP address.
IPv4 netmask	Input WIFI AP network mask.
IPv4 gateway	Input WIFI AP gateway.
Start IP/End IP	Input start IP and end IP. The NVR can allocate the IP address in the range you specified here.
Upgrade	Click it to upgrade WIFI AP module.

5.10.2.4 WIFI

Please note this function is for the device of WIFI module.

The WIFI interface is shown as in Figure 5-36.

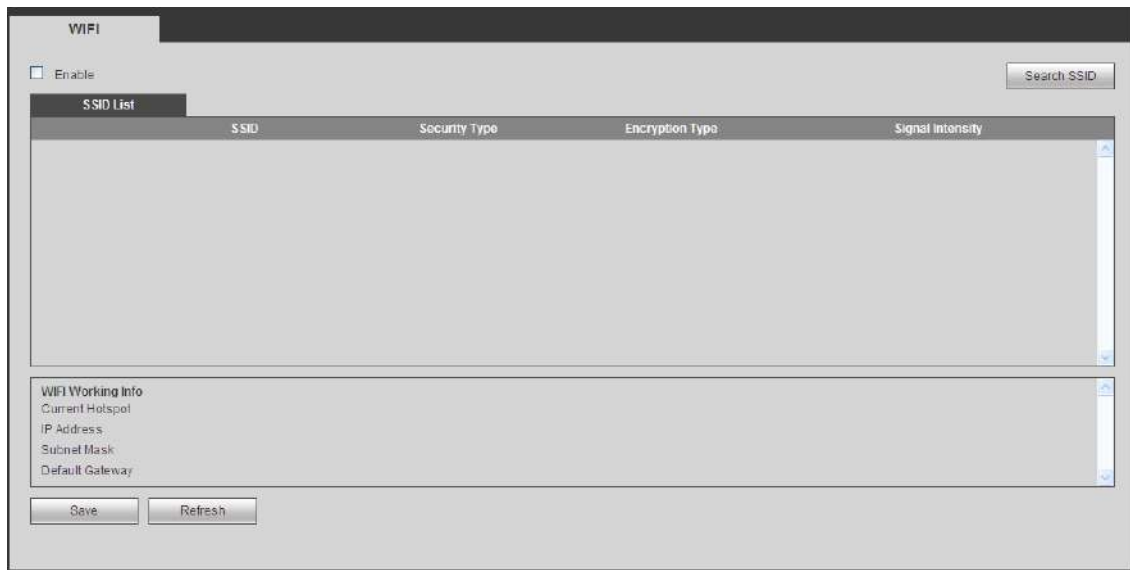

Figure 5-36

Please check the box to enable WIFI function and then click the Search SSID button. Now you can view all the wireless network information in the following list. Double click a name to connect to it. Click Refresh button, you can view latest connection status.

5.10.2.5 3G

5.10.2.5.1 CDMA/GPRS

The CDMA/GPRS interface is shown as in Figure 5-37.

Figure 5-37

Please refer to the following sheet for detailed information.



Parameter	Function
WLAN type	Here you can select 3G network type to distinguish the 3G module from different ISP. The types include WCDMA, CDMA1x and etc.
APN/Dial No.	Here is the important parameter of PPP.
Authorization	It includes PAP,CHAP,NO_AUTH.
Pulse interval	It is to set time to end 3G connection after you close extra stream monitor. For example, if you input 60 here, system ends 3G connection after you close extra stream monitor 60 seconds.
Important <ul style="list-style-type: none"> ✦ If the pulse interval is 0, then system does not end 3G connection after you close the extra stream monitor. ✦ Pulse interval here is for extra stream only. This item is null if you are using main stream to monitor. 	

5.10.2.5.2 Mobile

The mobile setup interface is shown as in Figure 5-38.

Here you can activate (send out “on”) or turn off (Send out “off”) the 3G connected phone or mobile phone,

or the phone you set to get alarm message.

Check send SMS box and then input the phone number in the receiver column. Click  to add one receiver. Repeat the above steps you can add more phones. Select a phone number and then click , you can delete it. Click OK button to complete the setup.

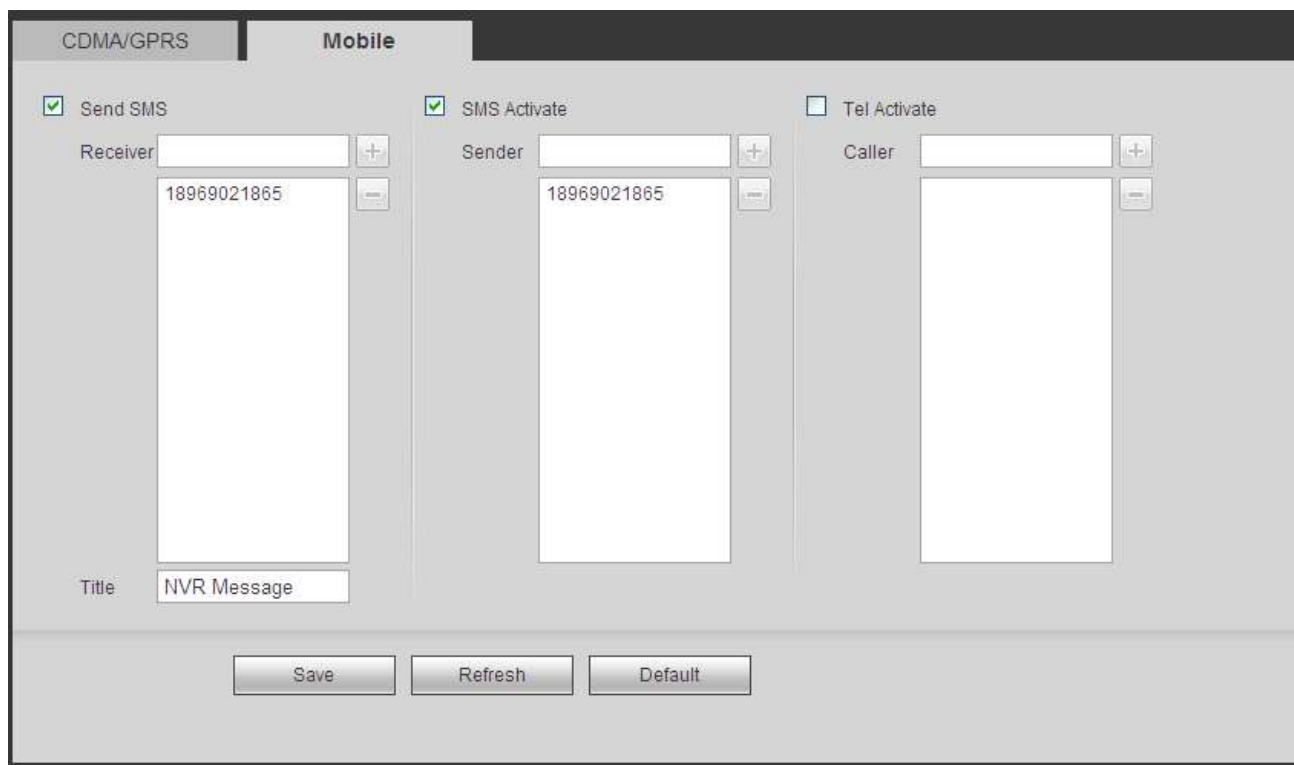

The screenshot shows a configuration window titled "Mobile" with two tabs: "CDMA/GPRS" and "Mobile". The "Mobile" tab is active. It contains three columns of settings:

- Send SMS:** A checked checkbox. Below it is a "Receiver" field with a list of numbers, currently showing "18969021865". There are "+" and "-" buttons next to the field.
- SMS Activate:** A checked checkbox. Below it is a "Sender" field with a list of numbers, currently showing "18969021865". There are "+" and "-" buttons next to the field.
- Tel Activate:** An unchecked checkbox. Below it is a "Caller" field with an empty list. There are "+" and "-" buttons next to the field.

At the bottom left, there is a "Title" field containing "NVR Message". At the bottom center, there are three buttons: "Save", "Refresh", and "Default".

Figure 5-38

5.10.2.6 PPPoE

The PPPoE interface is shown as in Figure 5-39.

Input the PPPoE user name and password you get from the IPS (internet service provider) and enable PPPoE function. Please save current setup and then reboot the device to get the setup activated.

Device connects to the internet via PPPoE after reboot. You can get the IP address in the WAN from the IP address column.

Please note, you need to use previous IP address in the LAN to login the device. Please go to the IP address item to via the device current device information. You can access the client-end via this new address.

Figure 5-39

5.10.2.7 DDNS

The DDNS interface is shown as in Figure 5-40.

The DDNS is to set to connect the various servers so that you can access the system via the server. Please go to the corresponding service website to apply a domain name and then access the system via the domain. It works even your IP address has changed.

Please select DDNS from the dropdown list (Multiple choices). Before you use this function, please make sure your purchased device support current function.

Figure 5-40

Please refer to the following sheet for detailed information.

Parameter	Function
Server Type	You can select DDNS protocol from the dropdown list and then enable DDNS function.
Server IP	DDNS server IP address
Server Port	DDNS server port.
Domain Name	Your self-defined domain name.
User	The user name you input to log in the server.
Password	The password you input to log in the server.
Update period	Device sends out alive signal to the server regularly. You can set interval value between the device and DDNS server

Parameter	Function
	here.

After setting, click Save button.

Input full domain name on the browser and click Enter button. The setting is right if you can view device WEB interface. Otherwise, please check the parameters.

5.10.2.8 Email

The email interface is shown as in Figure 5-41.

Figure 5-41

Please refer to the following sheet for detailed information.

Parameter	Function
Enable	Please check the box here to enable email function.
SMTP Server	Input server address and then enable this function.
Port	Default value is 25. You can modify it if necessary.
Anonymity	For the server supports the anonymity function. You can auto login anonymously. You do not need to input the user name, password and the sender information.
User Name	The user name of the sender email account.
Password	The password of sender email account.
Sender	Sender email address.
Authentication (Encryption mode)	You can select SSL or none.
Subject	Input email subject here.

Parameter	Function
Attachment	System can send out the email of the snapshot picture once you check the box here.
Receiver	Input receiver email address here. Max three addresses. It supports SSL, TLS email box.
Interval	The send interval ranges from 0 to 3600 seconds. 0 means there is no interval. Please note system will not send out the email immediately when the alarm occurs. When the alarm, motion detection or the abnormality event activates the email, system sends out the email according to the interval you specified here. This function is very useful when there are too many emails activated by the abnormality events, which may result in heavy load for the email server.
Health mail enable	Please check the box here to enable this function.
Update period (interval)	This function allows the system to send out the test email to check the connection is OK or not. Please check the box to enable this function and then set the corresponding interval. The value ranges from 30 minutes to 1440 minutes. System can send out the email regularly as you set here.
Email test	The system will automatically sent out a email once to test the connection is OK or not .Before the email test, please save the email setup information.

5.10.2.9 UPnP

It allows you to establish the mapping relationship between the LAN and the public network.

Here you can also add, modify or remove UPnP item. See Figure 5-42.

- In the Windows OS, From Start->Control Panel->Add or remove programs. Click the “Add/Remove Windows Components” and then select the “Network Services” from the Windows Components Wizard.
- Click the Details button and then check the “Internet Gateway Device Discovery and Control client” and “UPnP User Interface”. Please click OK to begin installation.
- Enable UPnP from the Web. If your UPnP is enabled in the Windows OS, the NVR can auto detect it via the “My Network Places”

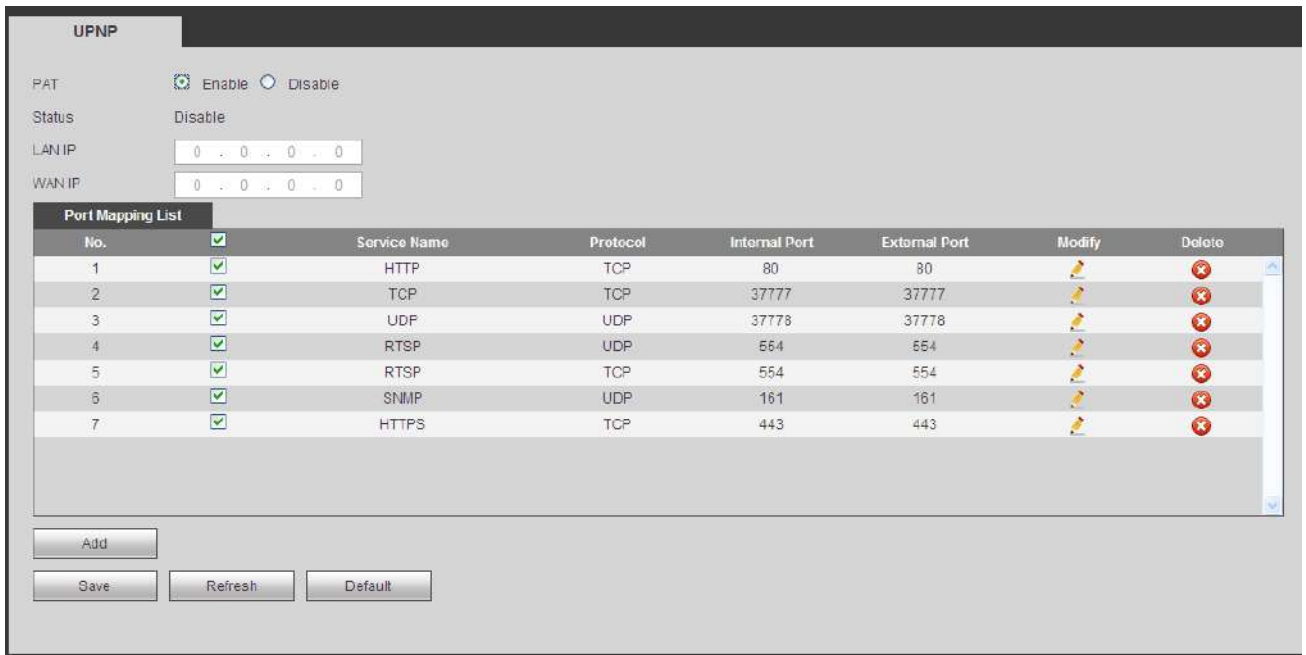



Figure 5-42

Please refer to the following sheet for detailed information.

Parameter	Function
PAT	Check the corresponding box to enable PAT function.
Status	Display UPnP function status.
Port mapping list	<p>It is corresponding to the UPnP mapping information on the router. Check the box before the service name to enable current PAT service. Otherwise, the service is null.</p> <ul style="list-style-type: none"> • Service name: Customized name. • Protocol: Protocol type. • Internal port: The port mapped to the port. • External port: The port current device needs to map. • Device has three mapping items: HTTP/TCP/UDP. <p>Note When you set the external port (output) of the router, the value ranges from 1024 to 5000. Do not use port 1~255 or system port 256~1023, in case there is conflict.</p>
Add	<p>Click Add button to add map relationship.</p> <p>Note For the data transmission protocol TCP/UDP, the external port and the internal port shall be the same to guarantee proper data transmission.</p>
Delete	Select one service and then click  to delete map relationship.

5.10.2.10 SNMP

The SNMP interface is shown as in Figure 5-43.

The SNMP allows the communication between the network management work station software and the proxy of the managed device. It is reserved for the 3rd party to develop.

SNMP V1/V2

Enable

SNMP Port: (0~65535)

Read Community:

Write Community:

Trap Address:

Trap Port: (0~65535)

Version: V1 V2

Figure 5-43

Please refer to the following sheet for detailed information.

Parameter	Function
SNMP Port	The listening port of the proxy program of the device. It is a UDP port not a TCP port. The value ranges from 1 to 65535. The default value is 161
Read Community	It is a string. It is a command between the manage process and the proxy process. It defined the authentication, access control and the management relationship between one proxy and one group of the managers. Please make sure the device and the proxy are the same. The read community will read all the objects the SNMP supported in the specified name. The default setup is public.
Write Community	It is a string. It is a command between the manage process and the proxy process. It defined the authentication, access control and the management relationship between one proxy and one group of the managers. Please make sure the device and the proxy are the same. The read community will read/write/access all the objects the SNMP supported in the specified name. The default setup is write.
Trap address	The destination address of the Trap information from the proxy program of the device.
Trap port	The destination port of the Trap information from the proxy program of the device. It is for the gateway device and the client-end PC in the LAN to exchange the information. It is a non-protocol connection port. It has no effect on the network applications. It is a UDP port not TCP port. The value ranges from 1 to 165535. The default value is 162.
SNMP version	<ul style="list-style-type: none"> ● Check V1, system only processes the information of V1. ● Check V2, system only processes the information of V2.

5.10.2.11 Multicast

The multicast interface is shown as in Figure 5-44.

Multicast is a transmission mode of data packet. When there is multiple-host to receive the same data

packet, multiple-cast is the best option to reduce the broad width and the CPU load. The source host can just send out one data to transit. This function also depends on the relationship of the group member and group of the outer.

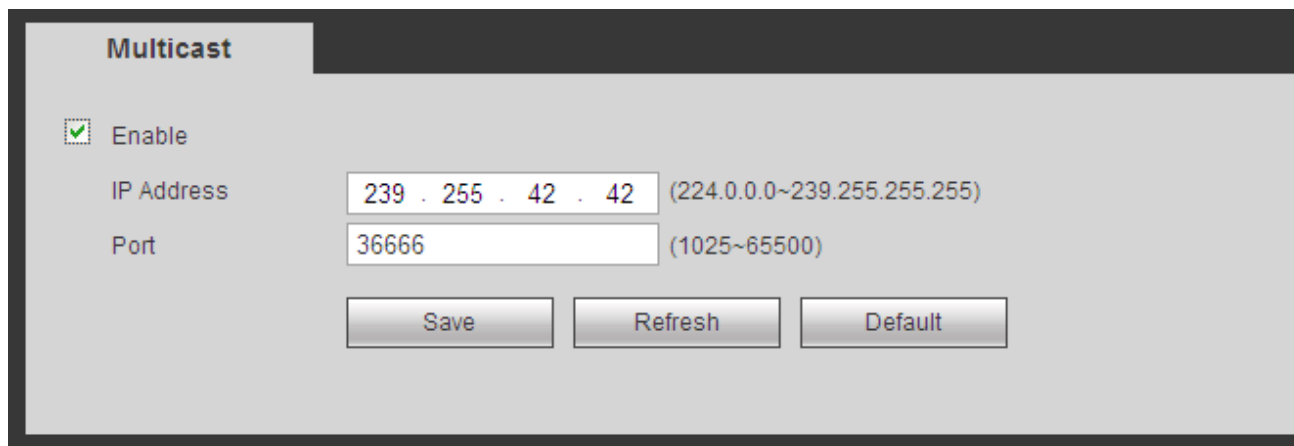

Multicast

Enable

IP Address (224.0.0.0~239.255.255.255)

Port (1025~65500)

Figure 5-44

5.10.2.12 Auto Register

The auto register interface is shown as below. See Figure 5-45.

This function allows the device to auto register to the proxy you specified. In this way, you can use the client-end to access the NVR and etc via the proxy. Here the proxy has a switch function. In the network service, device supports the server address of IPv4 or domain.

Please follow the steps listed below to use this function.

Please set proxy server address, port, and sub-device name at the device-end. Please enable the auto register function, the device can auto register to the proxy server.

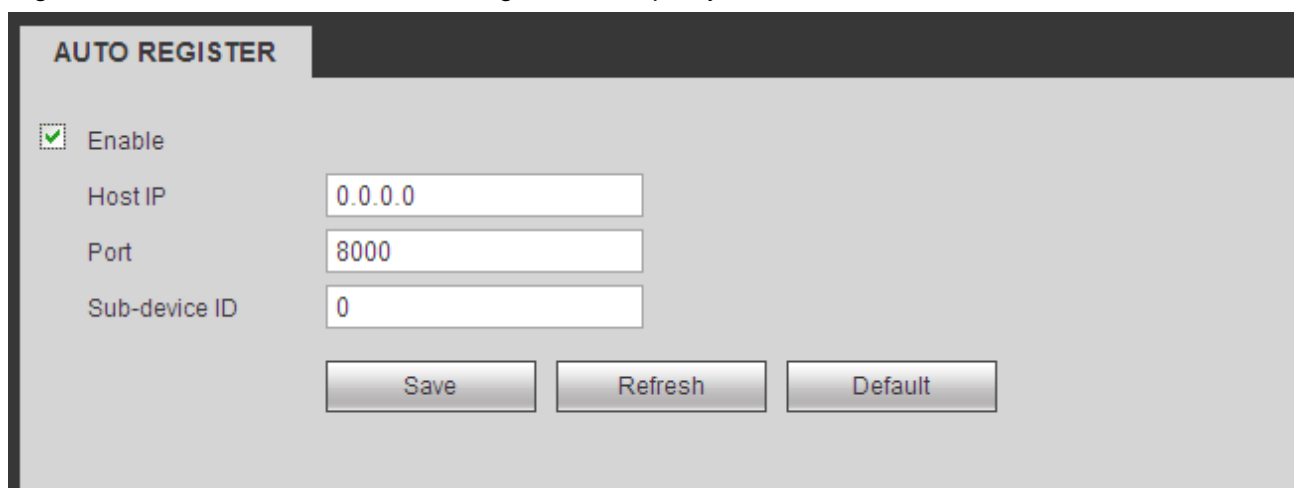

AUTO REGISTER

Enable

Host IP

Port

Sub-device ID

Figure 5-45

5.10.2.13 Alarm Centre

The alarm center interface is shown as below. See Figure 5-46.

This interface is reserved for you to develop. System can upload alarm signal to the alarm center when local alarm occurs.

Before you use alarm center, please set server IP, port and etc. When an alarm occurs, system can send out data as the protocol defined, so the client-end can get the data.

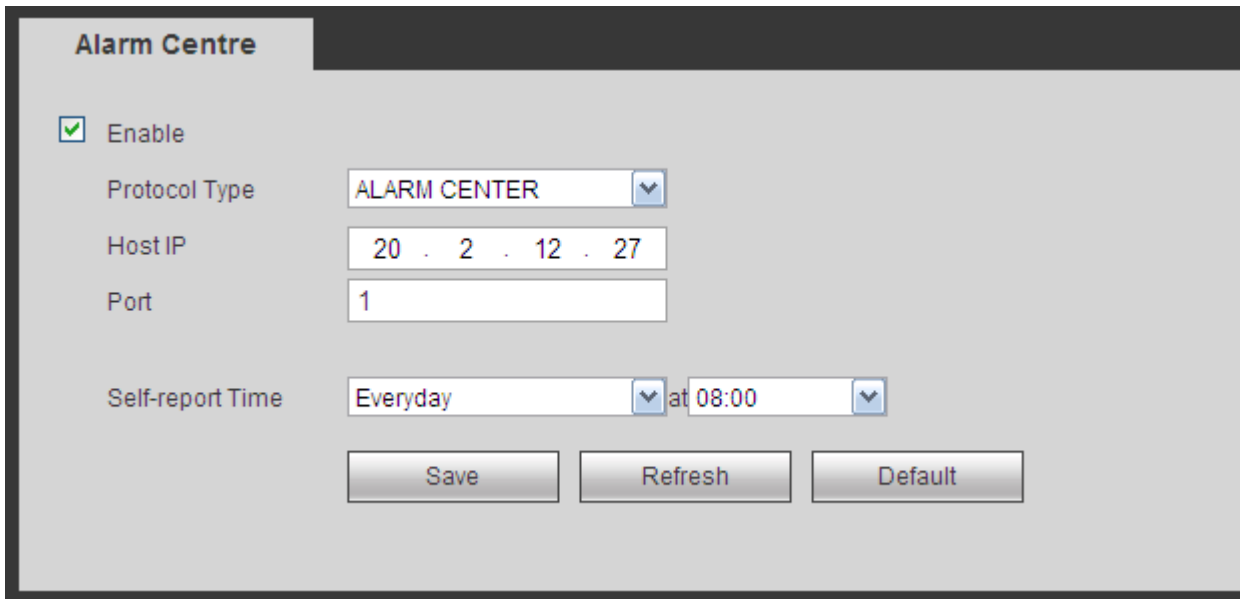

Figure 5-46

5.10.2.14 HTTPS

In this interface, you can set to make sure the PC can successfully login via the HTTPS. It is to guarantee communication data security. The reliable and stable technology can secure the user information security and device safety. See Figure 5-47.

Note

- You need to implement server certificate again if you have changed device IP.
- You need to download root certificate if it is your first time to use HTTPS on current PC.

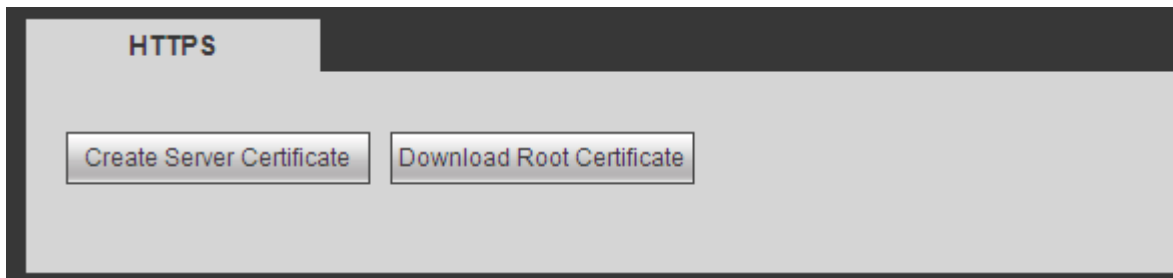
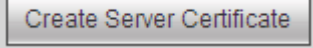

Figure 5-47

5.10.2.14.1 Create Server Certificate

If it is your first time to use this function, please follow the steps listed below.

In Figure 5-47, click  button, input country name, state name and etc. Click Create button. See Figure 5-48.

Note

Please make sure the IP or domain information is the same as your device IP or domain name.

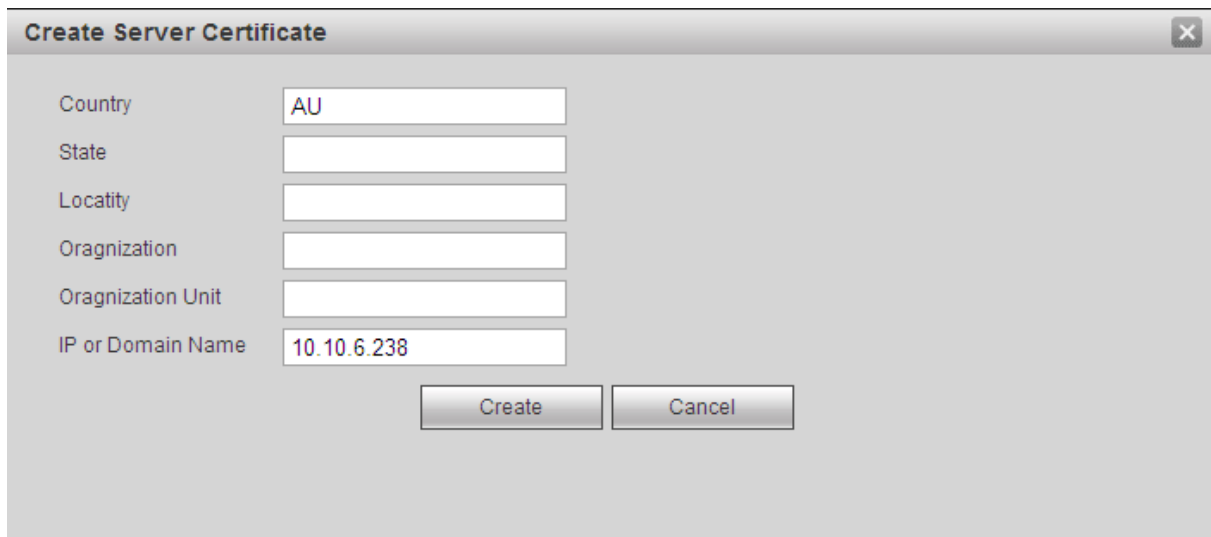

Figure 5-48

You can see the corresponding prompt. See Figure 5-49. Now the server certificate is successfully created.



Figure 5-49

5.10.2.14.2 Download root certificate

In Figure 5-47, click **Download Root Certificate** button, system pops up a dialogue box. See Figure 5-50.



Figure 5-50

Click Open button, you can go to the following interface. See Figure 5-51.

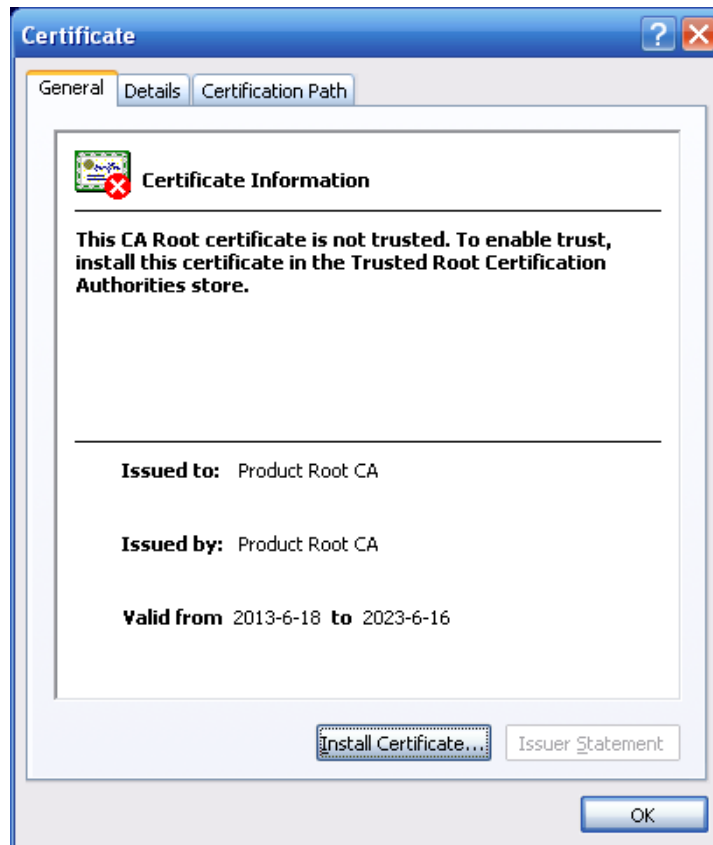

Figure 5-51

Click Install certificate button, you can go to certificate wizard. See Figure 5-52.



Figure 5-52

Click Next button to continue. Now you can select a location for the certificate. See Figure 5-53.

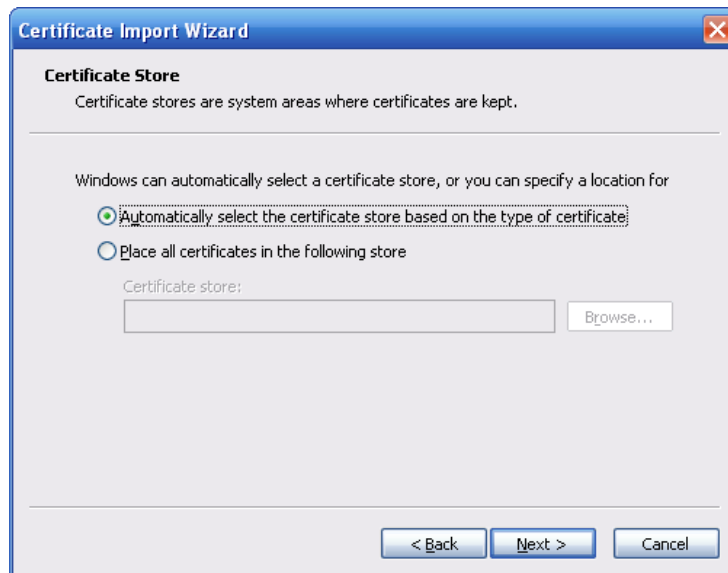

Figure 5-53

Click Next button, you can see the certificate import process is complete. See Figure 5-54.

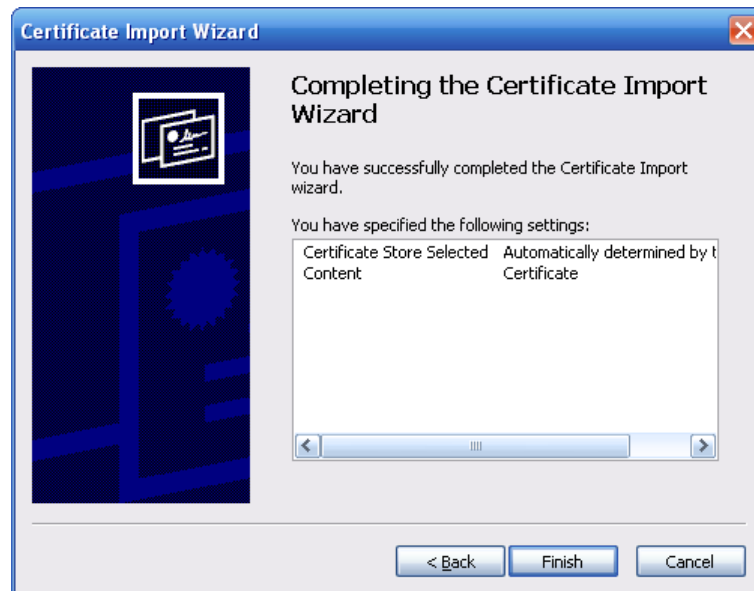

Figure 5-54

Click Finish button, you can see system pops up a security warning dialogue box. See Figure 5-55.



Figure 5-55

Click Yes button, system pops up the following dialogue box, you can see the certificate download is complete. See Figure 5-56.



Figure 5-56

5.10.2.14.3 View and set HTTPS port

From Setup->Network->Connection, you can see the following interface. See Figure 5-57. You can see HTTPS default value is 443.

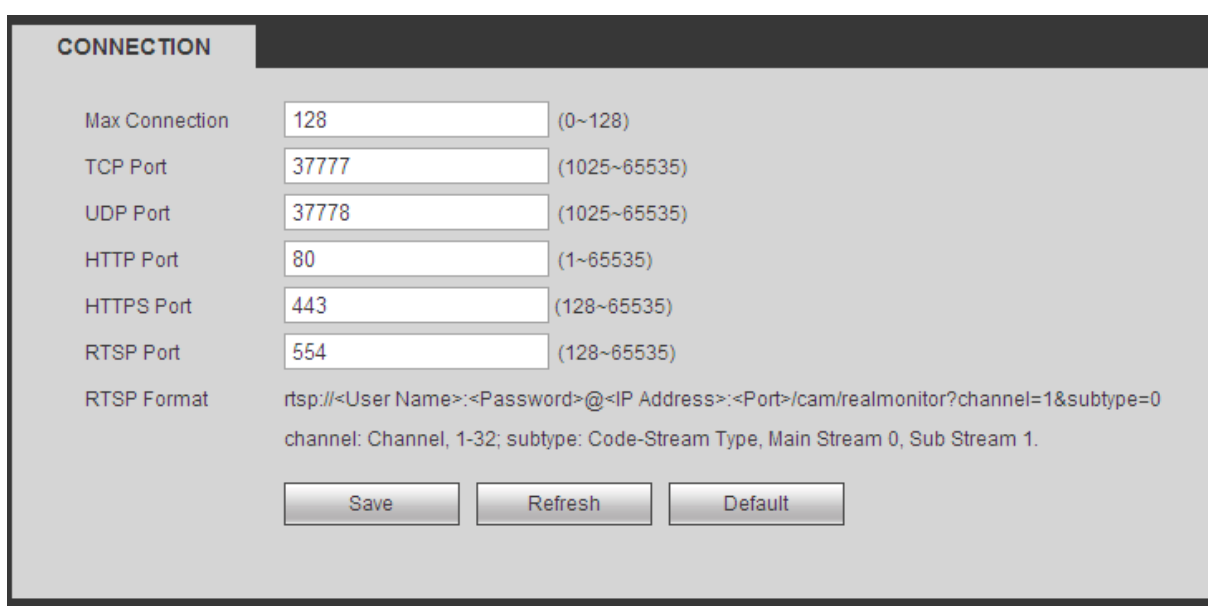

Figure 5-57

5.10.2.14.4 Login

Open the browser and then input <https://xx.xx.xx.xx:port>.

xx.xx.xx.xx: is your device IP or domain name.

Port is your HTTPS port. If you are using default HTTPS value 443, you do not need to add port information here. You can input <https://xx.xx.xx.xx> to access.

Now you can see the login interface if your setup is right.

5.10.2.15 P2P

You can use your cell phone to scan the QR code and add it to the cell phone client.

Via the SN from scanning the QR code, you can access the device in the WAN. Please refer to the P2P operation manual included in the resources CD.

The P2P interface is shown as in Figure 5-58.

Check the Enable box to enable P2P function and then click the Save button. Now you can view the device status and SN.



Figure 5-58

5.10.3 Event

5.10.3.1 Video detect

5.10.3.1.1 Motion Detect

After analysis video, system can generate a video loss alarm when the detected moving signal reached the sensitivity you set here.

The motion detect interface is shown as in Figure 5-59.

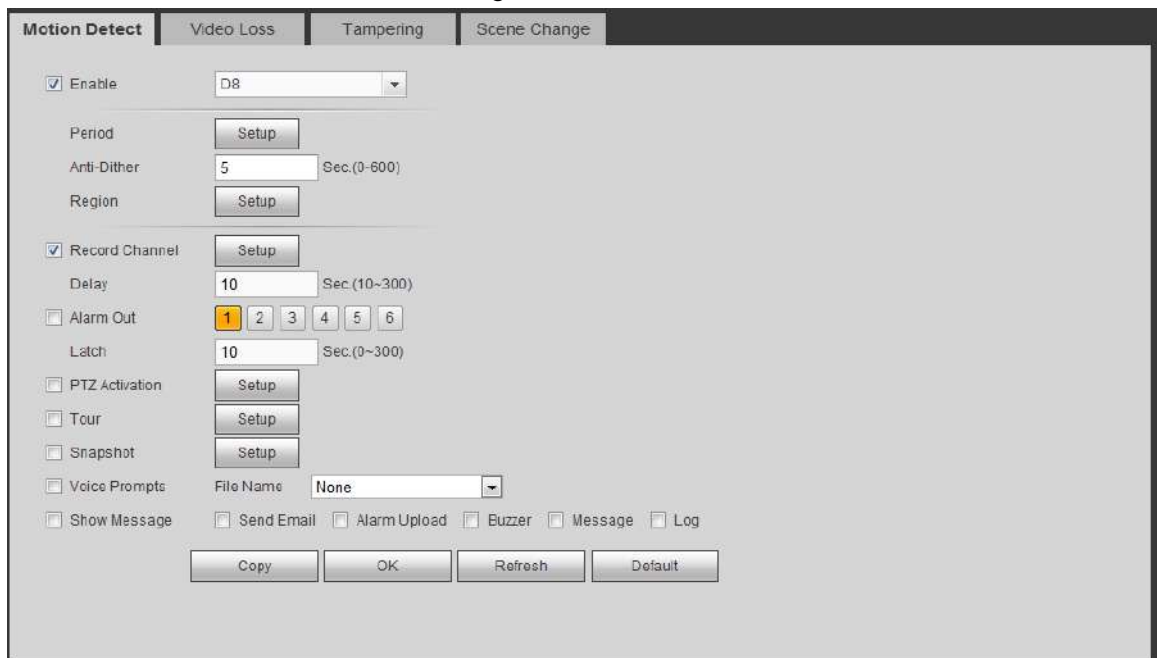

Figure 5-59

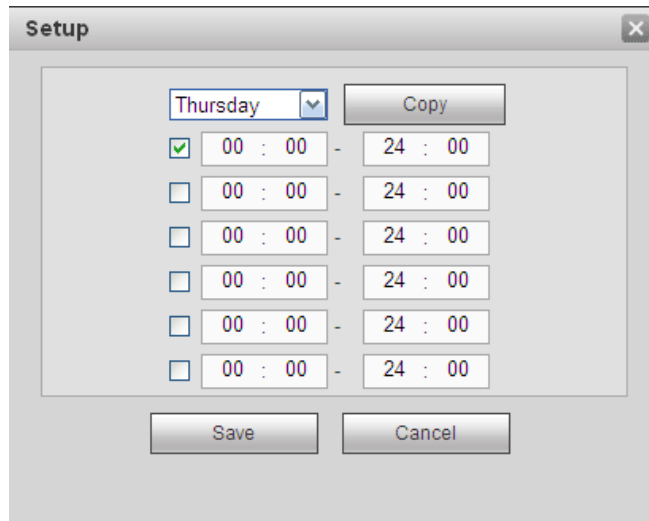

Figure 5-60

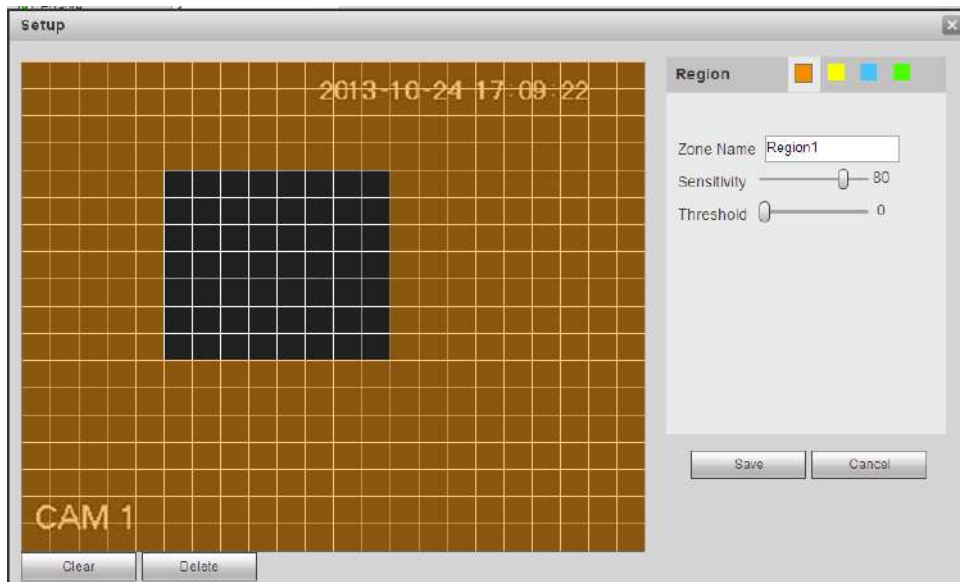

Figure 5-61

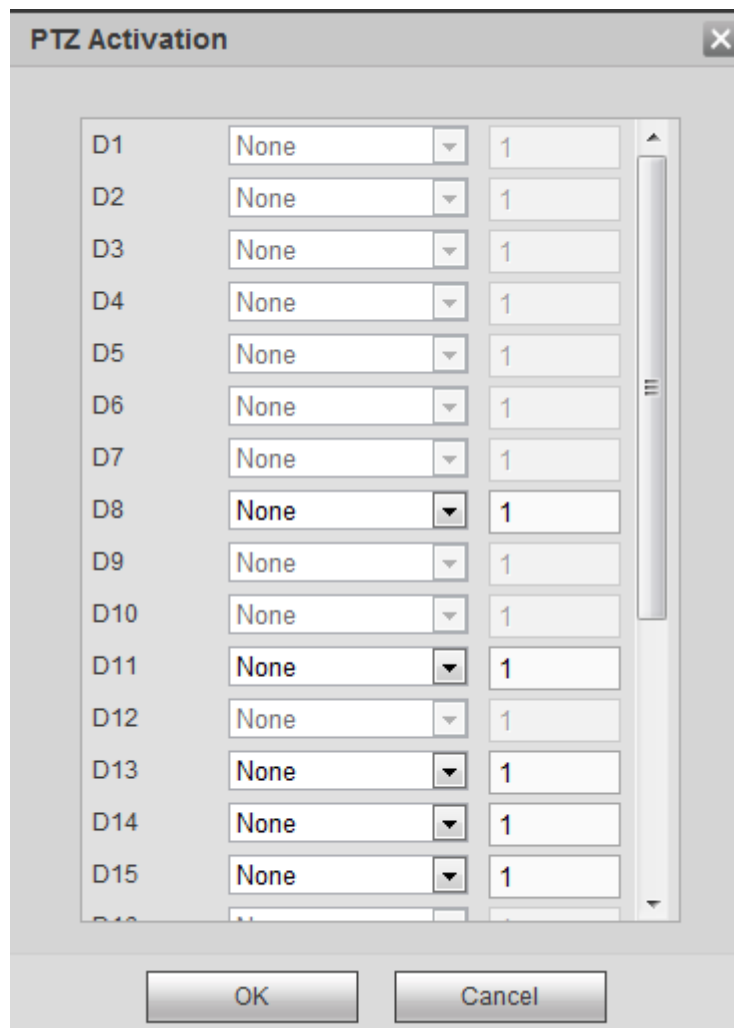

Figure 5-62

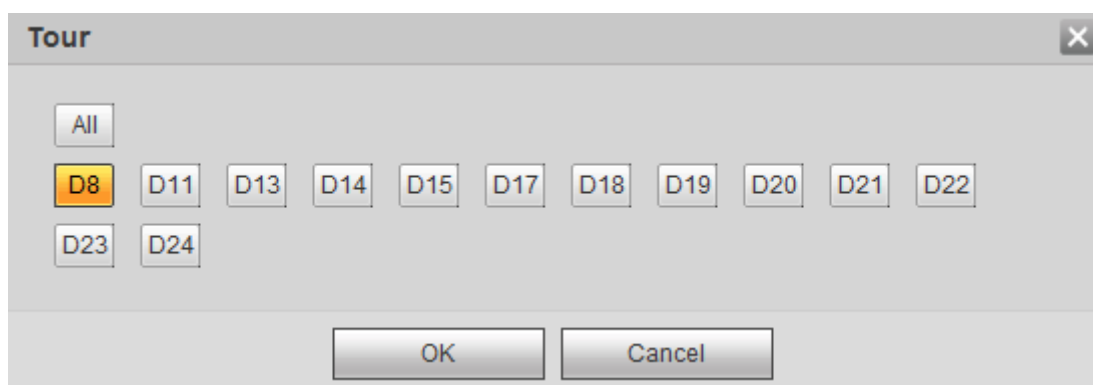

Figure 5-63

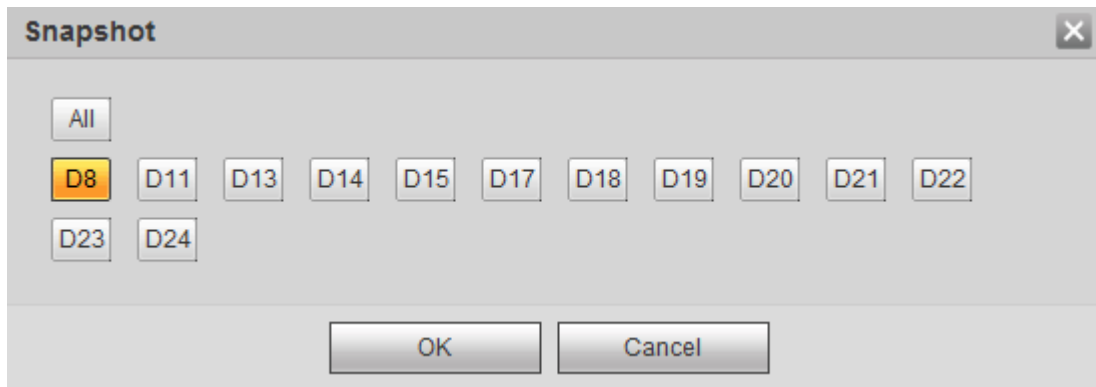

Figure 5-64

Please refer to the following sheet for detailed information.

Parameter	Function
Enable	You need to check the box to enable motion detection function. Please select a channel from the dropdown list.
Period	Motion detection function becomes activated in the specified periods. See Figure 5-60. There are six periods in one day. Please draw a circle to enable corresponding period. Click OK button, system goes back to motion detection interface, please click save button to exit.
Anti-dither	System only memorizes one event during the anti-dither period. The value ranges from 5s to 600s.
Sensitivity	There are six levels. The sixth level has the highest sensitivity.
Region	If you select motion detection type, you can click this button to set motion detection zone. The interface is shown as in Figure 5-61. Here you can set motion detection zone. There are four zones for you to set. Please select a zone first and then left drag the mouse to select a zone. The corresponding color zone displays different detection zone. You can click Fn button to switch between the arm mode and disarm mode. In arm mode, you can click the direction buttons to move the green rectangle to set the motion detection zone. After you completed the setup, please click ENTER button to exit current setup. Do remember click save button to save current setup. If you click ESC button to exit the region setup interface system will not save your zone setup.
Record channel	System auto activates motion detection channel(s) to record once an alarm occurs. Please note you need to set motion detect record period and go to Storage-> Schedule to set current channel as schedule record.
Record Delay	System can delay the record for specified time after alarm ended. The value ranges from 10s to 300s.
Alarm out	Enable alarm activation function. You need to select alarm output port so that system can activate corresponding alarm device when an alarm occurs.
Latch	System can delay the alarm output for specified time after an

Parameter	Function
	alarm ended. The value ranges from 1s to 300s.
Show message	System can pop up a message to alarm you in the local host screen if you enabled this function.
Buzzer	Check the box here to enable this function. The buzzer beeps when an alarm occurs.
Alarm upload	System can upload the alarm signal to the center (Including alarm center).
Message	When 3G network connection is OK, system can send out a message when motion detect occurs.
Send Email	If you enabled this function, System can send out an email to alert you when an alarm occurs.
Tour	You need to click setup button to select tour channel. System begins 1-window or multiple-window tour display among the channel(s) you set to record when an alarm occurs. See Figure 5-63.
PTZ Activation	Here you can set PTZ movement when alarm occurs. Such as go to preset X. See Figure 5-62.
Snapshot	Click setup button to select snapshot channel. See Figure 5-64.
Video Matrix	This function is for motion detect only. Check the box here to enable video matrix function. Right now system supports one-channel tour function. System takes "first come and first serve" principle to deal with the activated tour. System will process the new tour when a new alarm occurs after previous alarm ended. Otherwise it restores the previous output status before the alarm activation.

5.10.3.1.2 Video Loss

The video loss interface is shown as in Figure 5-65.

Please note video loss does not support anti-dither, sensitivity, region setup. For rest setups, please refer to chapter 5.10.3.1.1 motion detect for detailed information.

Figure 5-65

5.10.3.1.3 Tampering

The tampering interface is shown as in Figure 5-66.

After analysis video, system can generate a tampering alarm when the detected moving signal reached the sensitivity you set here.

For detailed setups, please refer to chapter 5.10.3.1.1 motion detect for detailed information.

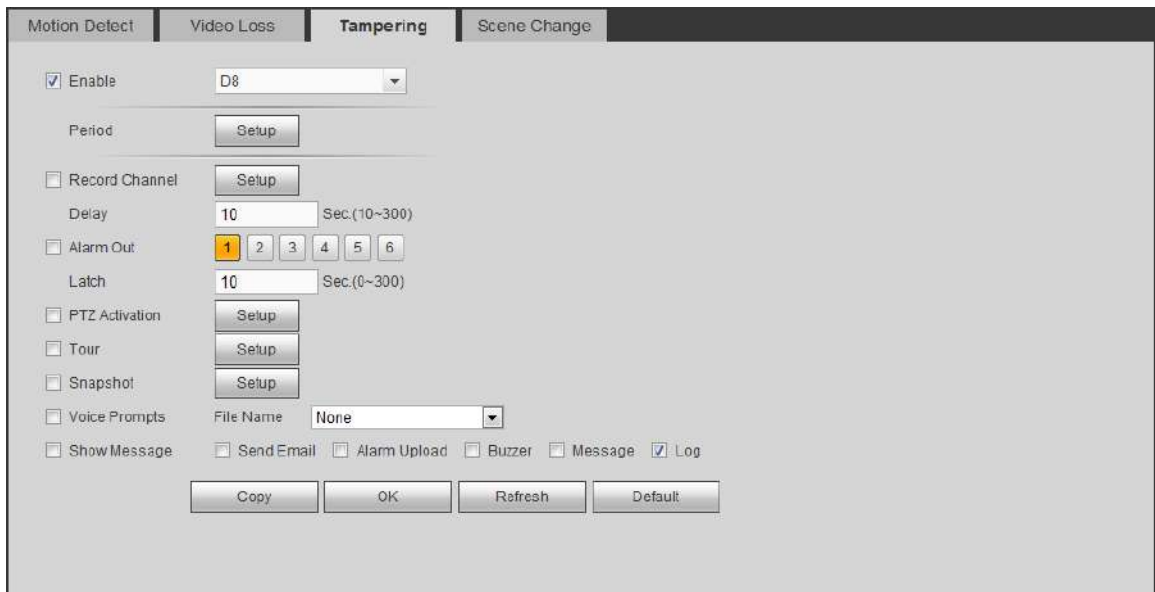

Figure 5-66

5.10.3.1.1 Scene Change

From main window->Setup->Event->Video detect->Scene change, the video diagnosis interface is shown as in Figure 5-67.

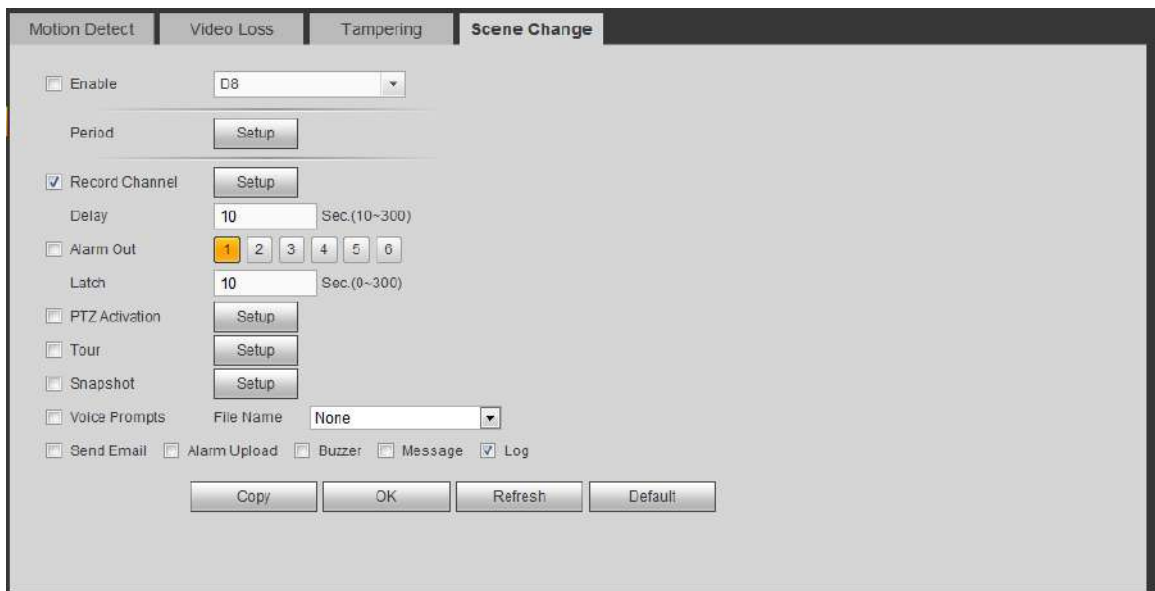

Figure 5-67

For detailed setups, please refer to chapter 5.10.3.1.1 motion detect for detailed information.

5.10.3.1 IVS Plan

The smart plan is for the smart network camera. If you do not set a rule here, you cannot use the intelligent functions in IVS (Chapter 5.10.3.2), Face detection (Chapter 5.10.3.3) and People counting (Chapter 5.10.3.4) when you are connecting to a smart network camera.

There are two types to realize intelligent analytics function.

 **Note**

- Smart network camera supports intelligent functions: Some smart camera supports the intelligent functions. For NVR, it just displays the intelligent alarm information from the smart network camera and set or playback the record file.
- NVR supports intelligent functions: The connected network camera does not support intelligent video analytics function. The NVR supports the analytics function.

From main menu->Setup->Event->IVS plan, you can go to the IVS plan interface. See Figure 5-68.

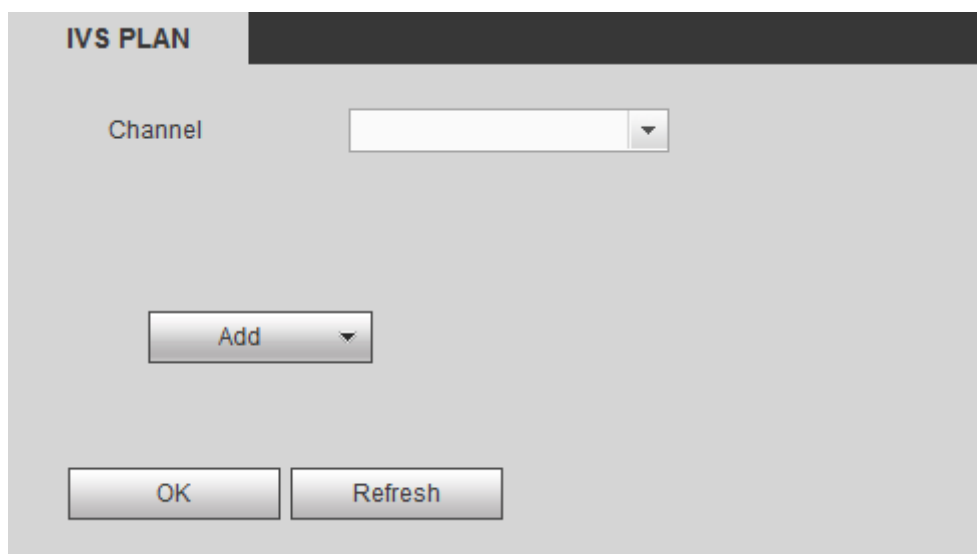

Figure 5-68

Select a channel from the dropdown list. Click Add button, you can see an interface shown as below. See Figure 5-69.

Select a channel from the dropdown list and then set preset. Click Add button and then set the corresponding rule.

 **Note**

Some smart camera does not need to add the preset. Please refer to the actual product for detailed information.

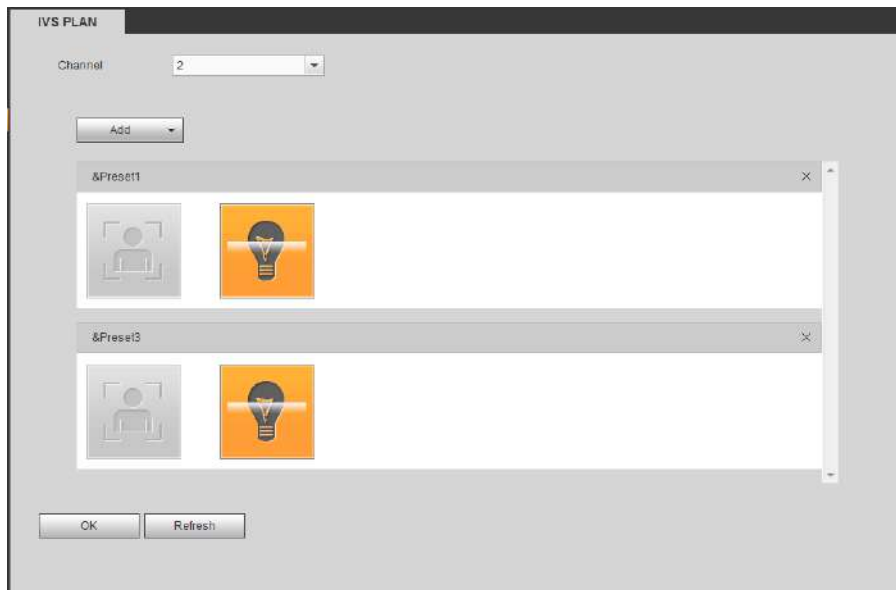

Figure 5-69

Click OK button to complete the setup.



Note

- The NVR supports general behavior analytics (IVS), human face detection, heat map, and people counting. Different network camera supports different smart plans. Please refer to the actual product for detailed information.
- The general behavior analytics (IVS) and human face detection function cannot be valid at the same time. For example, when add the IVS plan to the preset 1, the human face detection icon becomes grey.

5.10.3.2 IVS (Behavior Analytics) (Optional)

Once the object state has reached the threshold, NVR can trigger an intelligent alarm.



Note

- This function is for some series product only. Please refer to the actual product for detailed information.
- The IVS function and the human face detection function cannot be valid at the same time.

The IVS function environment shall meet the following requirements:

- The object total size shall not be more than 10% of the whole video.
- The object size on the video shall not be more than 10pixels*10 pixels. The abandoned object size shall be more than 15pixels*15 pixels (CIF resolution). The object width shall not be more than 1/3 of the video height and width. The recommended height is 10% of the video.
- The object and the background brightness different shall be more than 10 grey levels.
- The object shall remain on the video for more than 2 seconds. The moving distance is larger than its own width and shall not be smaller than 15pixels (CIF resolution).
- The surveillance environment shall not be too complicated. The IVS function is not suitable for the environment of too many objects or the changing light.
- The surveillance environment shall not contain glasses, reflection light from the ground, and water. Free of tree branches, shadow, mosquito and bugs. Do not use the IVS function in the backlight

environment, avoid direct sunlight.

5.10.3.2.1 Behavior Analytics

From main menu->Setup->Event->Behavior analytics->Behavior analytics, you can go to the Behavior analytics interface. See Figure 5-70.

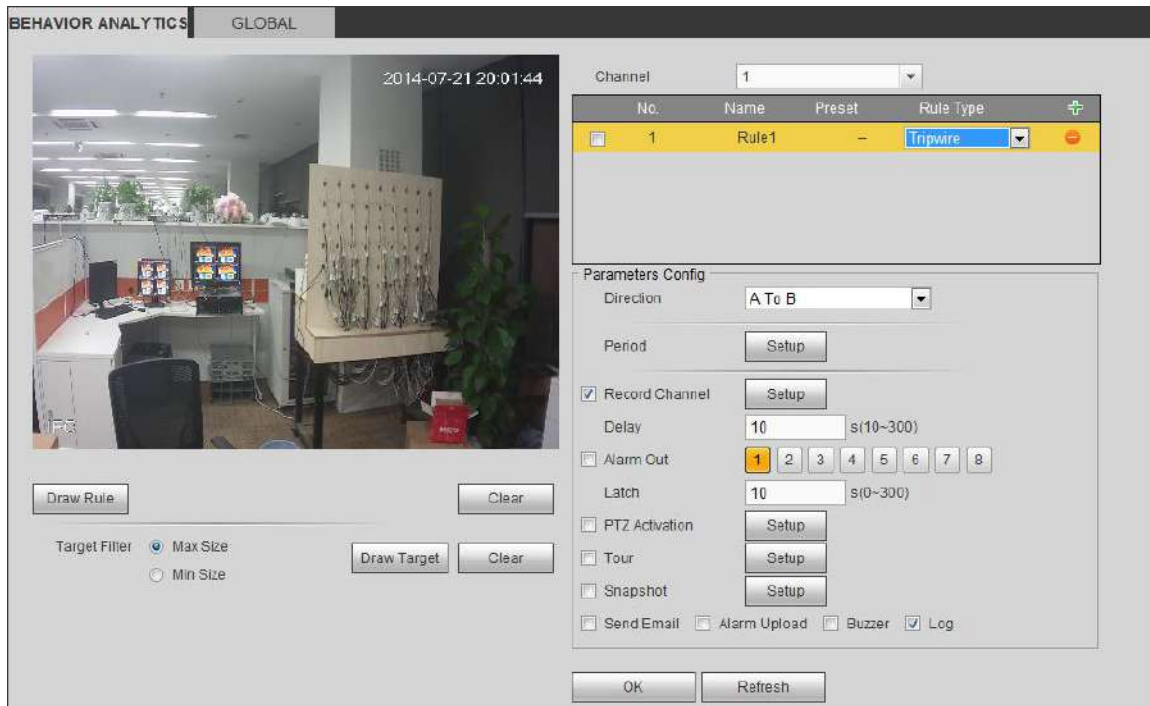



Figure 5-70

Please select a channel from the dropdown list

Click  to add a rule. The default setup is tripwire, you can double click the rule type name to modify. See Figure 5-71.

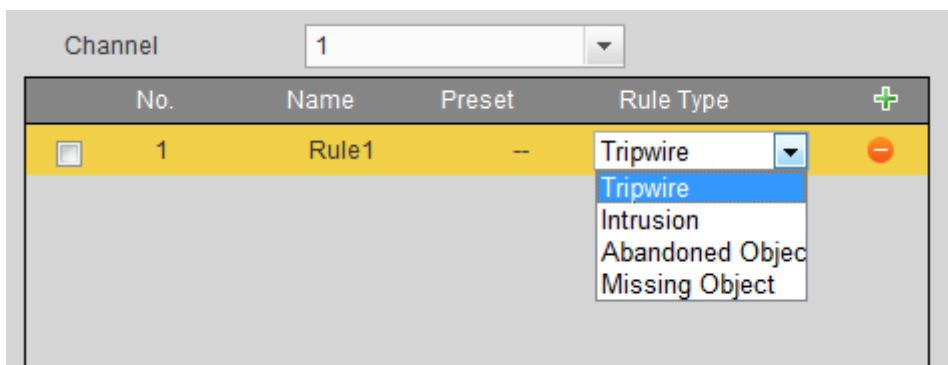



Figure 5-71

Then you can set corresponding parameters.

Click OK button to complete the setup.

5.10.3.2.1.1 Tripwire

From main menu->Setup->Event-> Behavior analytics->Behavior analytics, click  you can see the following interface. See Figure 5-72.

System generates an alarm once there is any object crossing the tripwire in the specified direction.

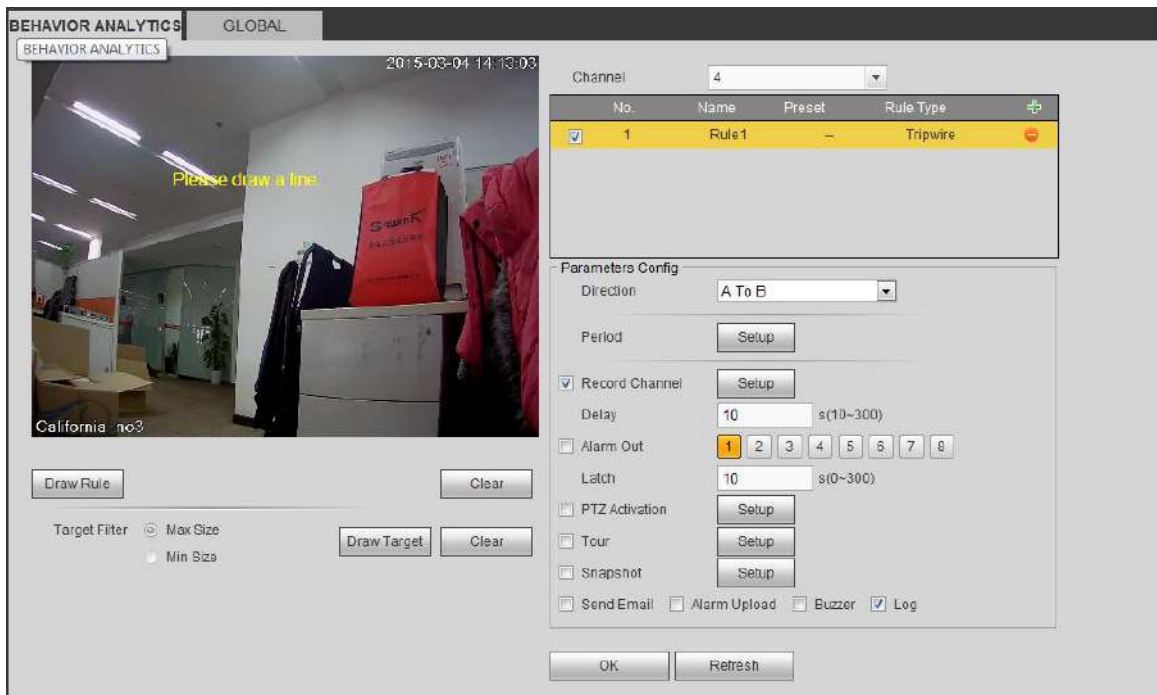

Figure 5-72

Check the Tripwire box to enable tripwire function.

Select SN (Line1/2/3/4) and direction, and then input customized rule name.

- Direction: There are three options: A->B, B->A, both. System can generate an alarm once there is any object crossing in the specified direction.

Now you can draw a rule. Click Draw rule button and then left click mouse to draw a tripwire. The tripwire can be a direct line, curve or polygon. Right click mouse to complete. See Figure 5-73.

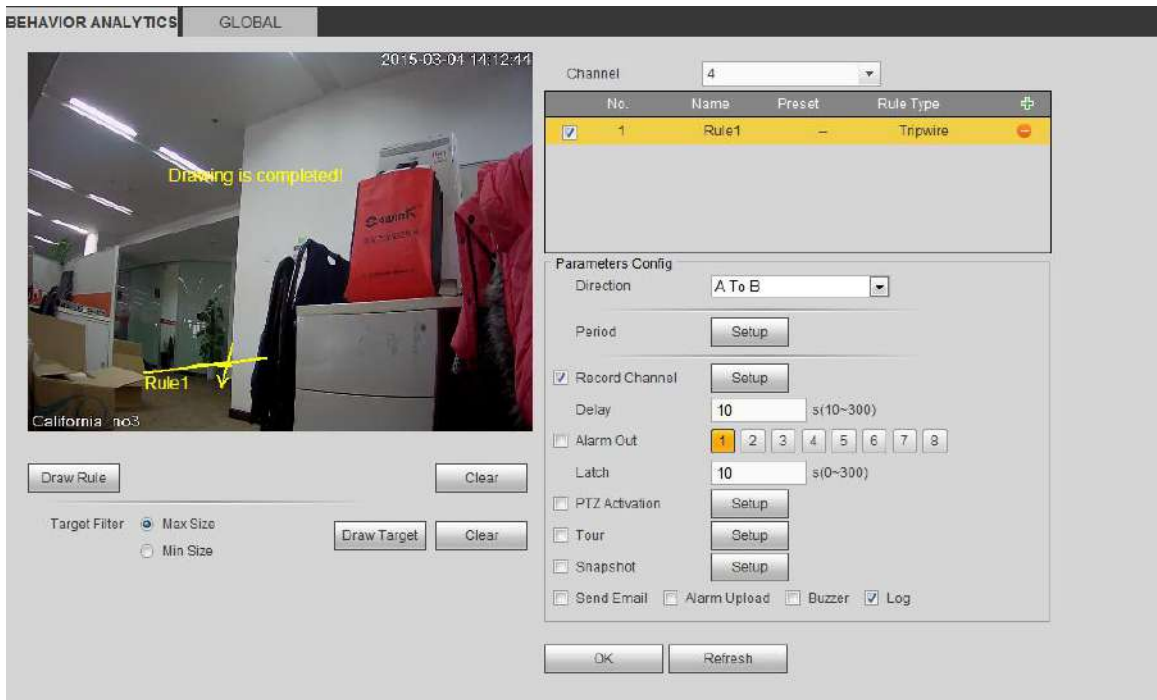

Figure 5-73

Click **Draw Target** to draw filter object. See Figure 5-74.

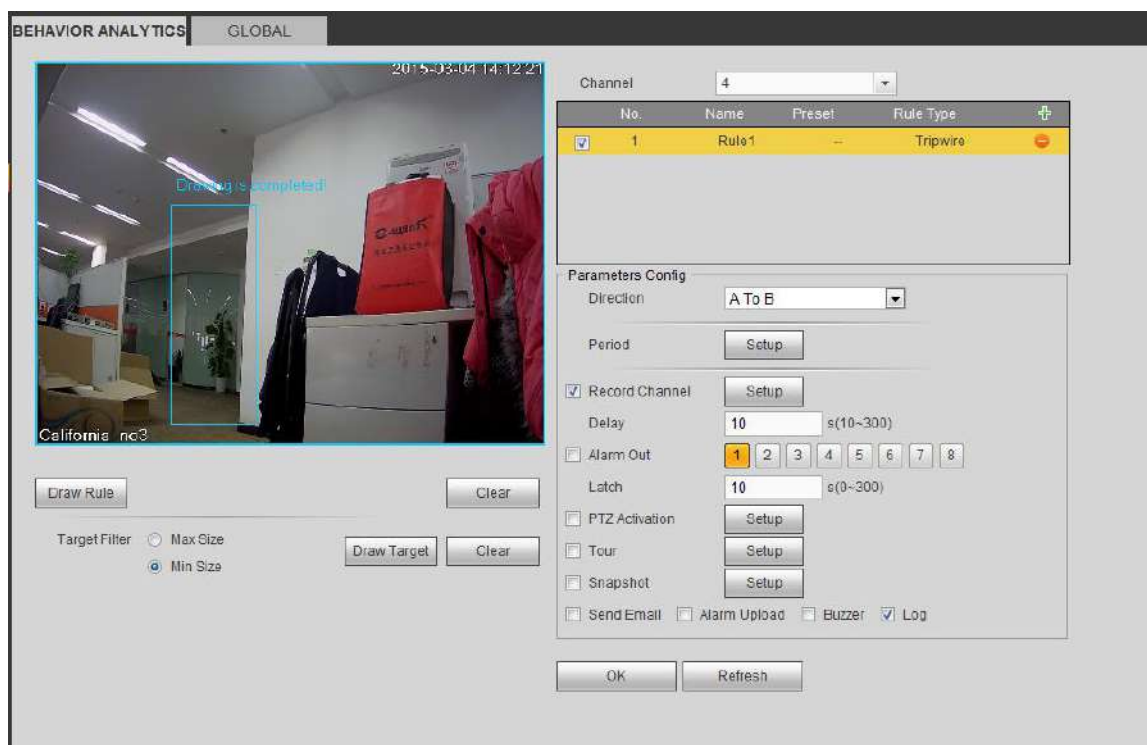

Figure 5-74

Select the blue line and then use mouse to adjust zone size.

Note

Each rule can set two sizes (min size/max size). Once the object is smaller than the min size or larger than the max size, there is no alarm. Please make sure the max size is larger than the min size.

Click Ok to complete the rule setup.

For detailed setups, please refer to chapter 5.10.3.1.1 motion detect for detailed information.

5.10.3.2.1.2 Intrusion (Cross warning zone)

From main menu->Setup->Event-> Behavior analytics->Behavior analytics, click , and then select rule type as intrusion, you can see the following interface. See Figure 4-126.

Note:

- System supports customized area shape and amount.
- Support enter/leave/both detection.
- Can detect the moving object operation in the specified zone, customized trigger amount and staying time.
- Support objects filter function.

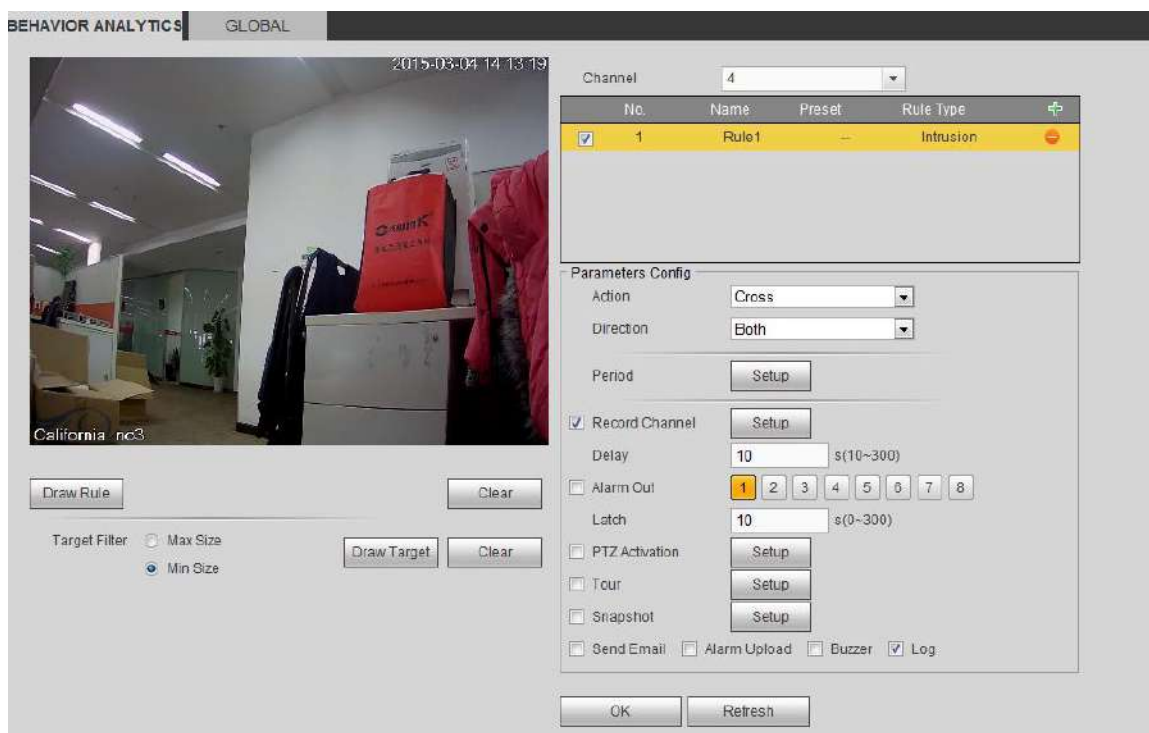

Figure 5-75

Check the Intrusion box to enable intrusion function.

Select SN (Area1/2/3/4) and direction, and then input customized rule name.

- Action: System supports two types: appear/cross.
- Direction: There are three options: A->B, B->A, both. System can generate an alarm once there is any object enter/exit (Or both) the zone.

Now you can draw a rule. Left click mouse to draw a line first and then right click mouse to draw another line until you draw a rectangle, you can right click mouse to exit.

Click Ok to complete the rule setup.

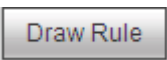
Click  to draw the zone. See Figure 5-76.

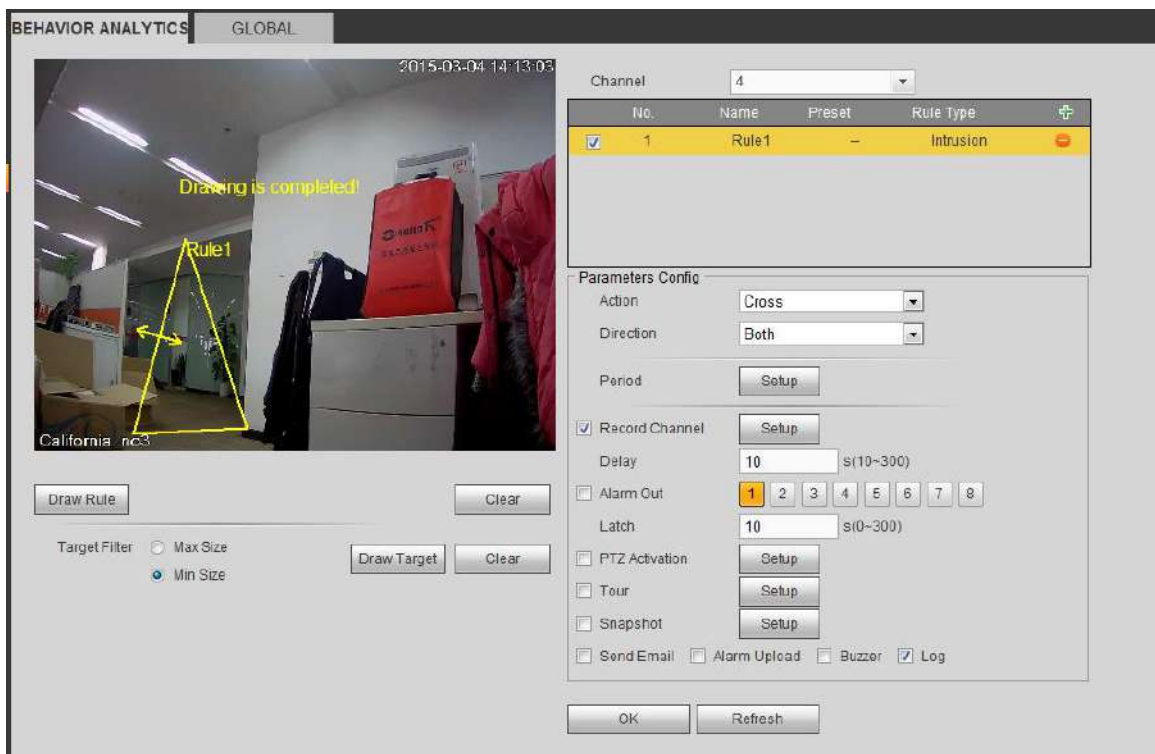



Figure 5-76

For detailed setups, please refer to chapter 5.10.3.1.1 motion detect for detailed information.

5.10.3.2.1.3 Abandoned Object Detect

From main menu->Setup->Event-> Behavior analytics->Behavior analytics, click , and then select rule type as abandoned object detection, you can see the following interface. See Figure 5-77.

- System supports customized area shape and amount.
- Support duration setup.
- Support objects filter function.

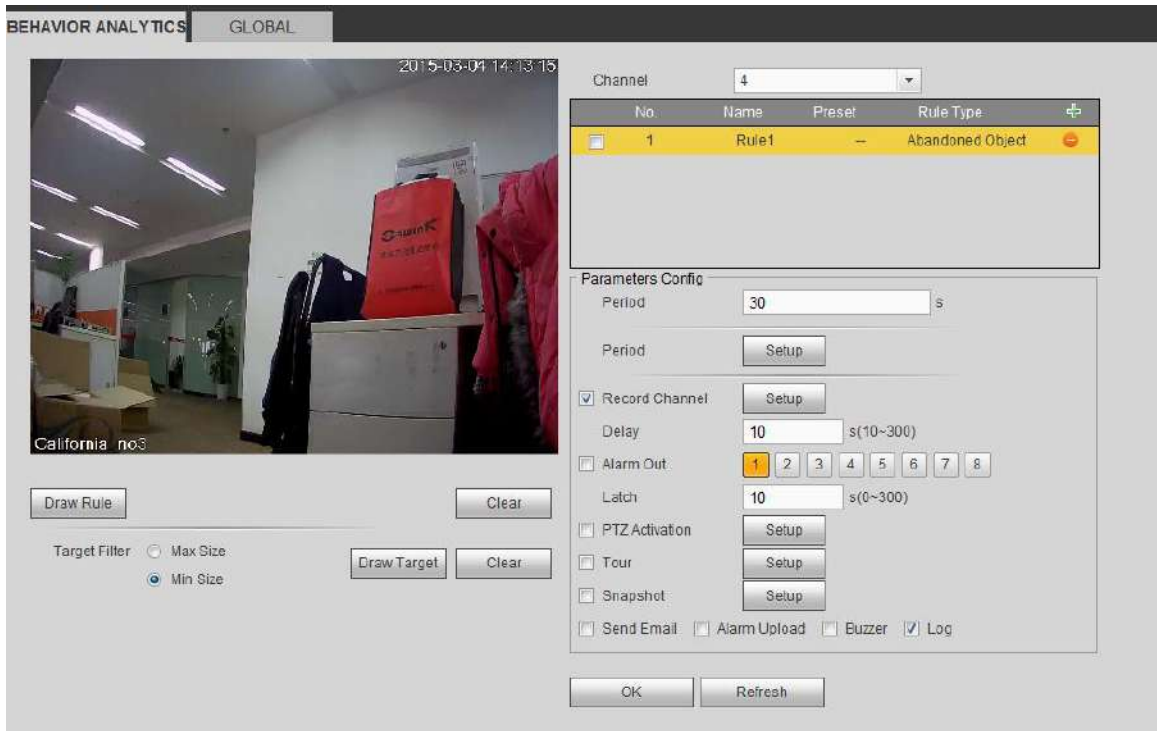

Figure 5-77

Check the Object box to enable object detect function.

- Period: System can generate an alarm once the object is in the zone for the specified period.

Click **Draw Rule** to draw the rule. See Figure 5-78.

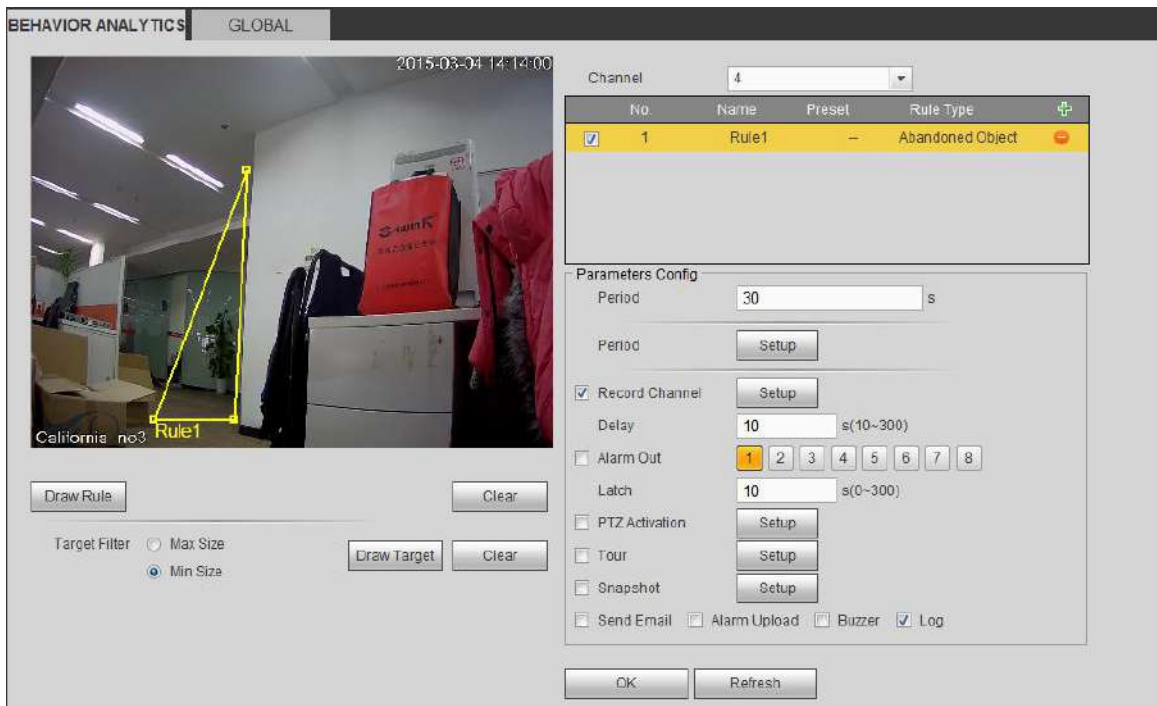



Figure 5-78

Now you can draw a rule. Left click mouse to draw a line, until you draw a rectangle, you can right click mouse.

Click Ok to complete the rule setup.

For detailed setups, please refer to chapter 5.10.3.1.1 motion detect for detailed information.

5.10.3.2.1.4 Missing Object Detect

From main menu->Setup->Event-> Behavior analytics->Behavior analytics, click , and then select rule type as missing object detection, you can see the following interface. See Figure 2-6.

- System supports customized area shape and amount.
- Support period setup.
- Support objects filter function.

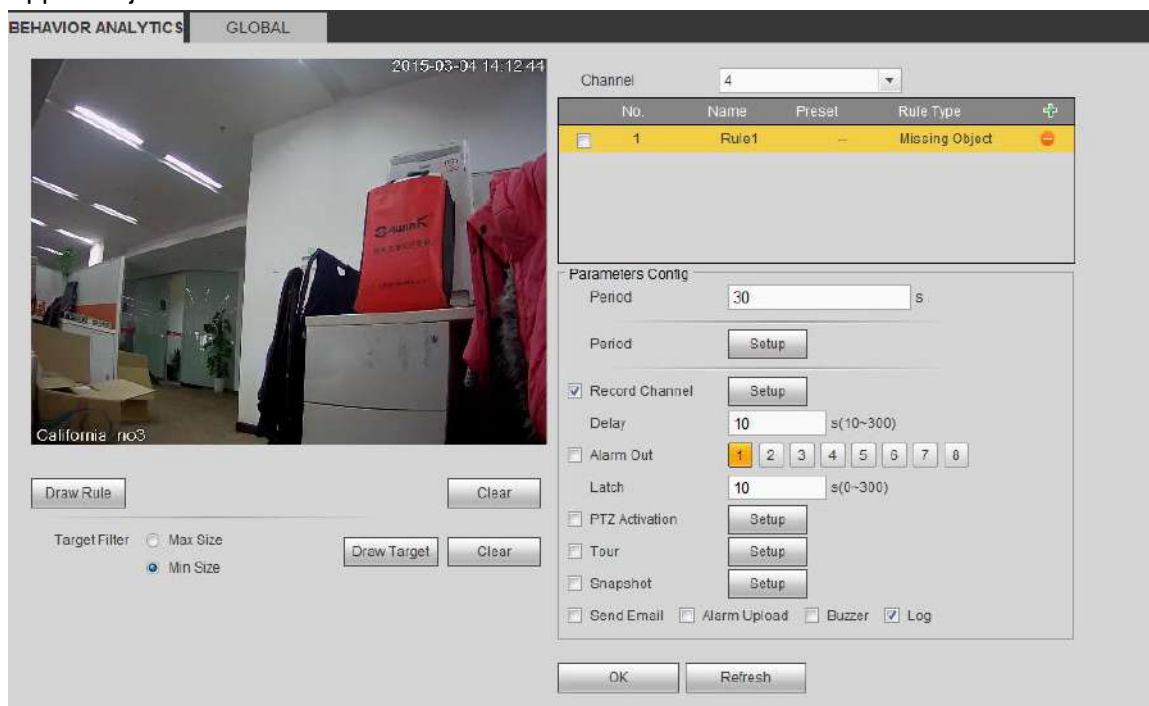
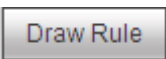

Figure 5-79

Click  to draw the rule. See Figure 5-80.

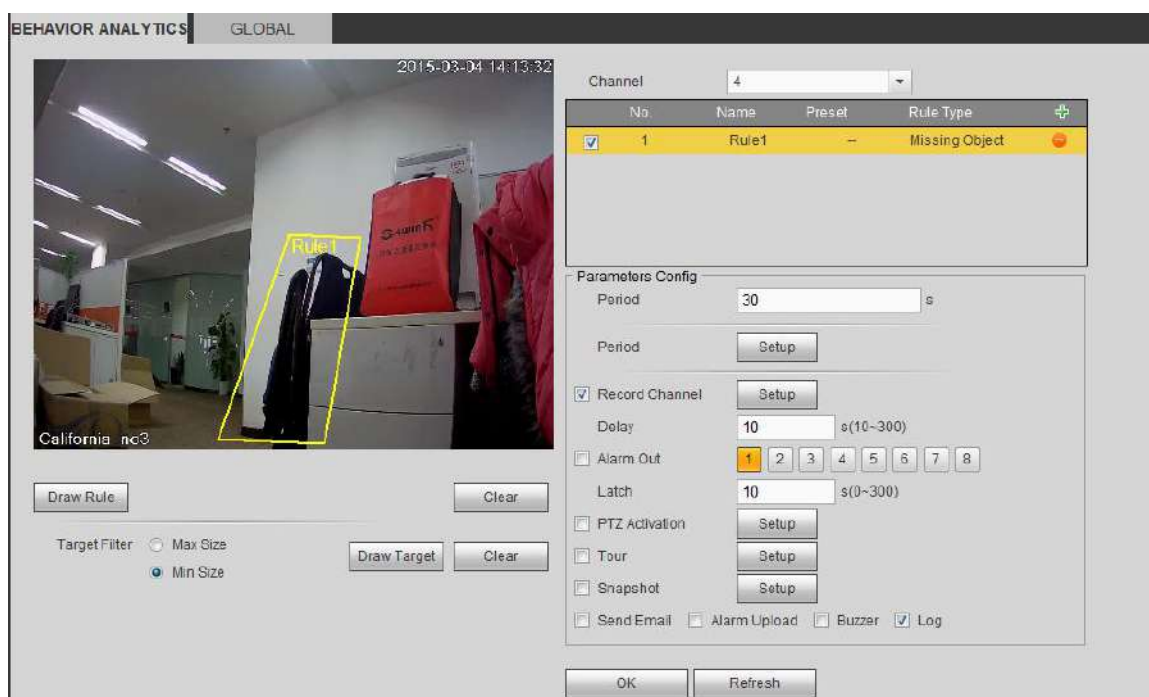



Figure 5-80

Click Ok to complete the rule setup.

For detailed setups, please refer to chapter 5.10.3.1.1 motion detect for detailed information.

5.10.3.2.1.5 Loitering

From main menu->Setup->Event-> Behavior analytics->Behavior analytics, click , and then select rule type as loitering detection, you can see the following interface. See Figure 2-19.

Note

- System supports customized area shape and amount.
- Support duration setup.
- Support objects filter function.

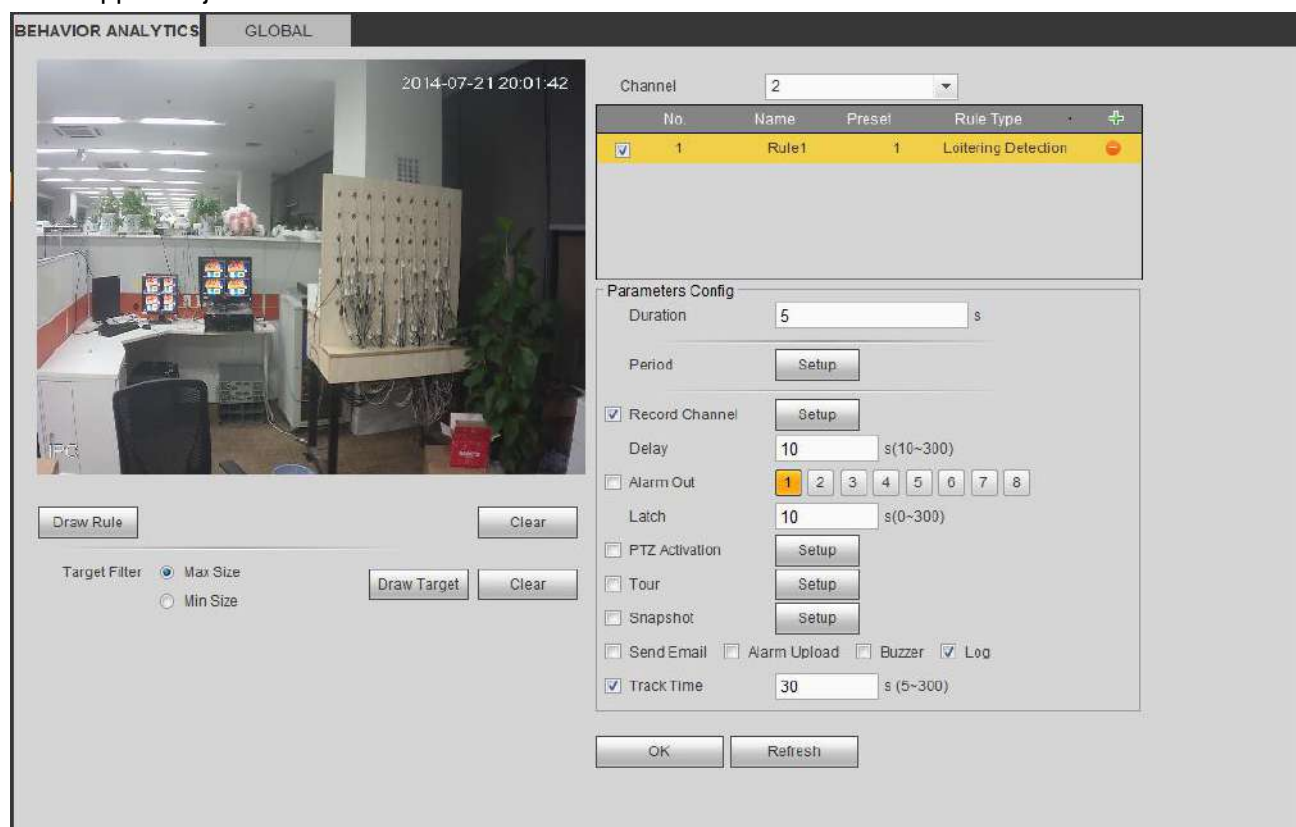

Figure 5-81

- Duration: System can generate an alarm once the object is in the zone for the specified period.

Click  to draw the rule.

Click OK to complete the rule setup.

For detailed setups, please refer to chapter 5.10.3.1.1 motion detect for detailed information.

5.10.3.2.1.6 Crowd gathering detection

From main menu->Setup->Event-> Behavior analytics->Behavior analytics, click , and then select rule type as crowd gathering estimation, you can see the following interface. See Figure 2-18.

- Customized zone and amount setup.
- Duration setup.
- Sensitivity setup.
- Min gathering zone setup.

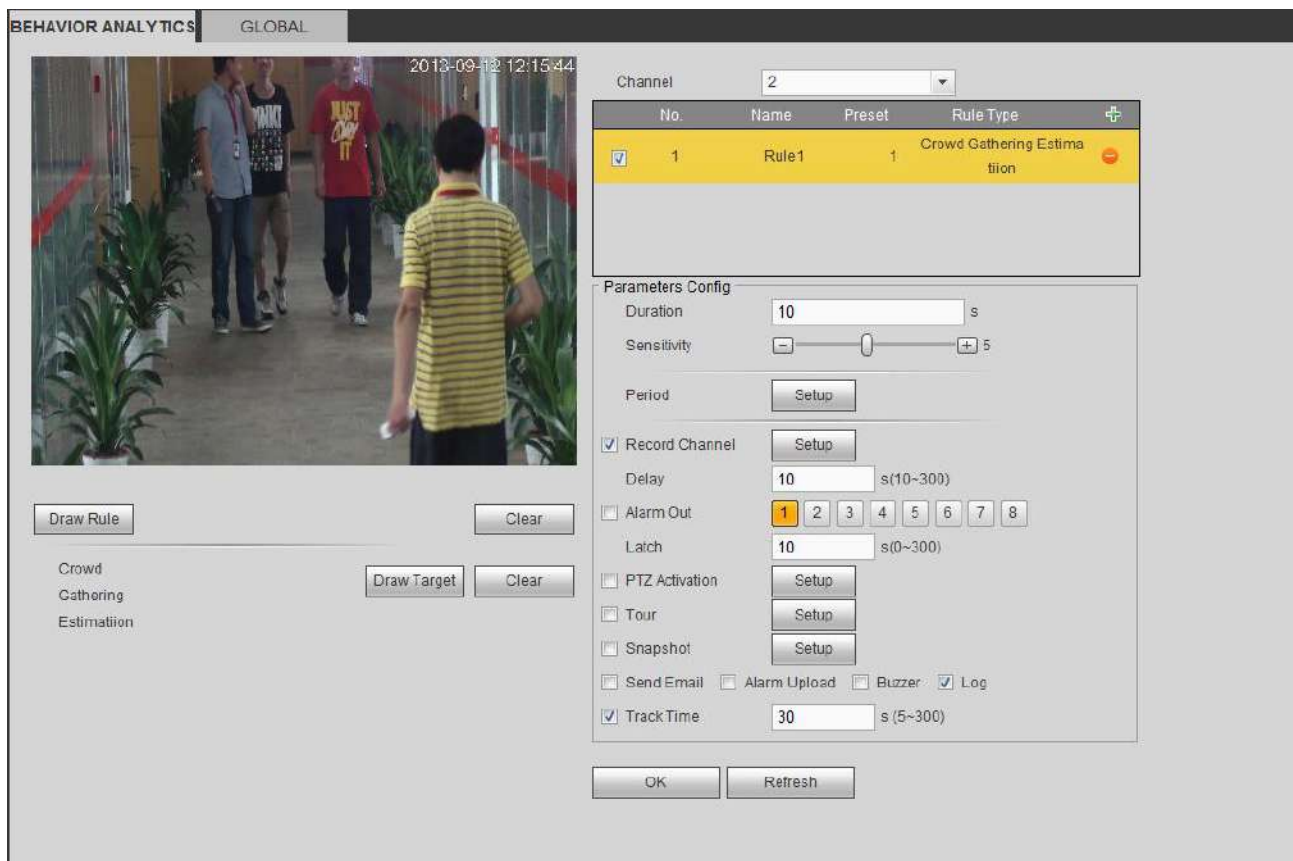

Figure 5-82

- Duration: System can generate an alarm once the object is in the zone for the specified period.
- Sensitivity: It is to set alarm sensitivity. The value ranges from 1 to 10. The default setup is 5.

Click to draw the rule.

Click OK to complete the rule setup.

For detailed setups, please refer to chapter 5.10.3.1.1 motion detect for detailed information.

5.10.3.2.1.7 Fast moving

From main menu->Setup->Event-> Behavior analytics->Behavior analytics, click , and then select rule type as fast moving, you can see the following interface. See Figure 2-17.

- Sensitivity: It is to set alarm sensitivity. The value ranges from 1 to 10. The default setup is 5.

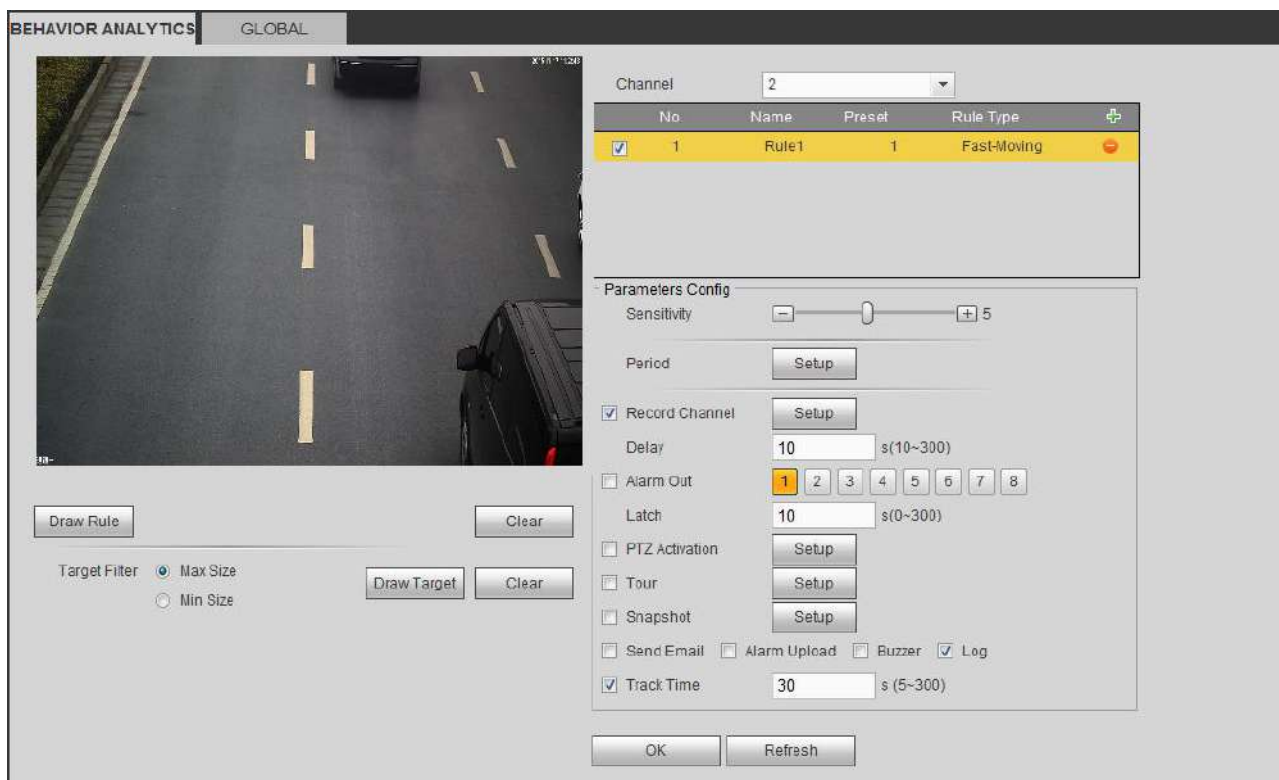
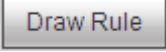

Figure 5-83

Click  to draw the rule.

Click OK to complete the rule setup.

For detailed setups, please refer to chapter 5.10.3.1.1 motion detect for detailed information.

5.10.3.2.2 Global Config

From main menu->Setup->Event->Behavior analytics->Global, you can go to the global configuration interface. See Figure 2-23.

- Channel: Please select a channel from the dropdown list.
- Preset: Select a preset you want to set the rule. Please note, you need to add a preset first, otherwise, you cannot see the preset dropdown list. If there is no preset, you can draw a rule in current channel.
- Calibration zone:
 - ✧ Click Add area , you can draw a calibration zone at the left pane of the interface. Select a zone and then click Delete zone button; you can remove the selected zone.
 - ✧ Select gauge type (vertical/level), you can set the corresponding length. You can draw three tilt gauges and one horizontal gauge at the left pane of the interface.
 - Select Width/Height and then click Verify, you can draw a line in the calibration zone, and then you can see its actual length.
 - Update preset: Click it to get the latest preset setup.

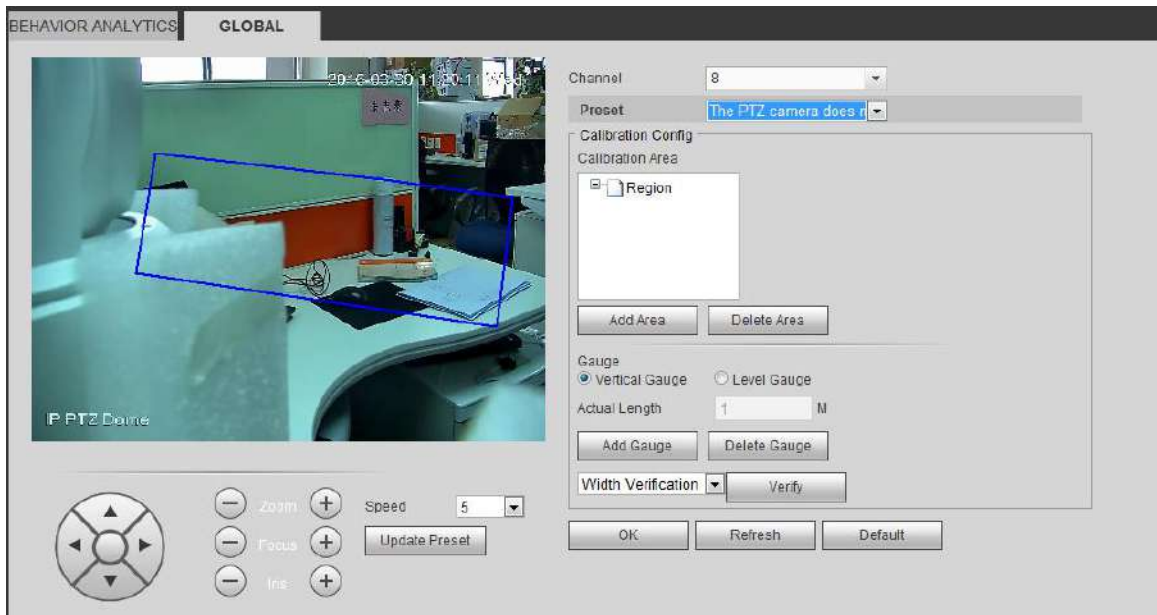

Figure 5-84

5.10.3.3 Face Detect (Optional)

When camera detects human face, system can generate an alarm.

From main menu->Setup->Event->Face detect, the interface is shown as in Figure 5-85.

- Enable face boost: Check the box here, system can enhance the human face display pane.
- Sensitivity: System supports 6 levels. The sixth level has the highest sensitivity.

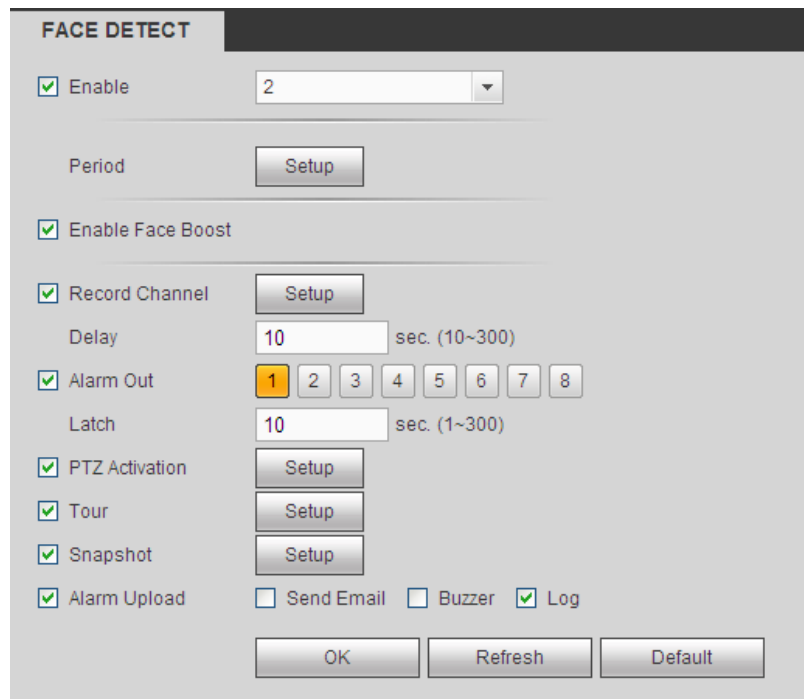

Figure 5-85

For detailed setups, please refer to chapter 5.10.3.1.1.

5.10.3.4 People Counting

System can calculate the entry/exit people amount in the specified zone. It can generate an alarm when the amount has exceeded the threshold.

From main menu->Setup->Event->People counting, you can see an interface shown as in Figure 2-29.

- Channel: Please select a channel from the dropdown list. Check the box to enable people counting function.
- OSD overlay: Check the box here; you can view the people amount on the surveillance video.
- Direction: It is to set people flow direction. It includes entry/exit.
- Entry No.: It is to set people entry amount. System can generate an alarm once the amount has exceeded the threshold.
- Exit No.: It is to set people entry amount. System can generate an alarm once the amount has exceeded the threshold.
- Stranded No.: It is to set people staying amount in the zone. System can generate an alarm once the amount has exceeded the threshold.

For detailed setups, please refer to chapter 5.10.3.1.1 motion detect for detailed information.

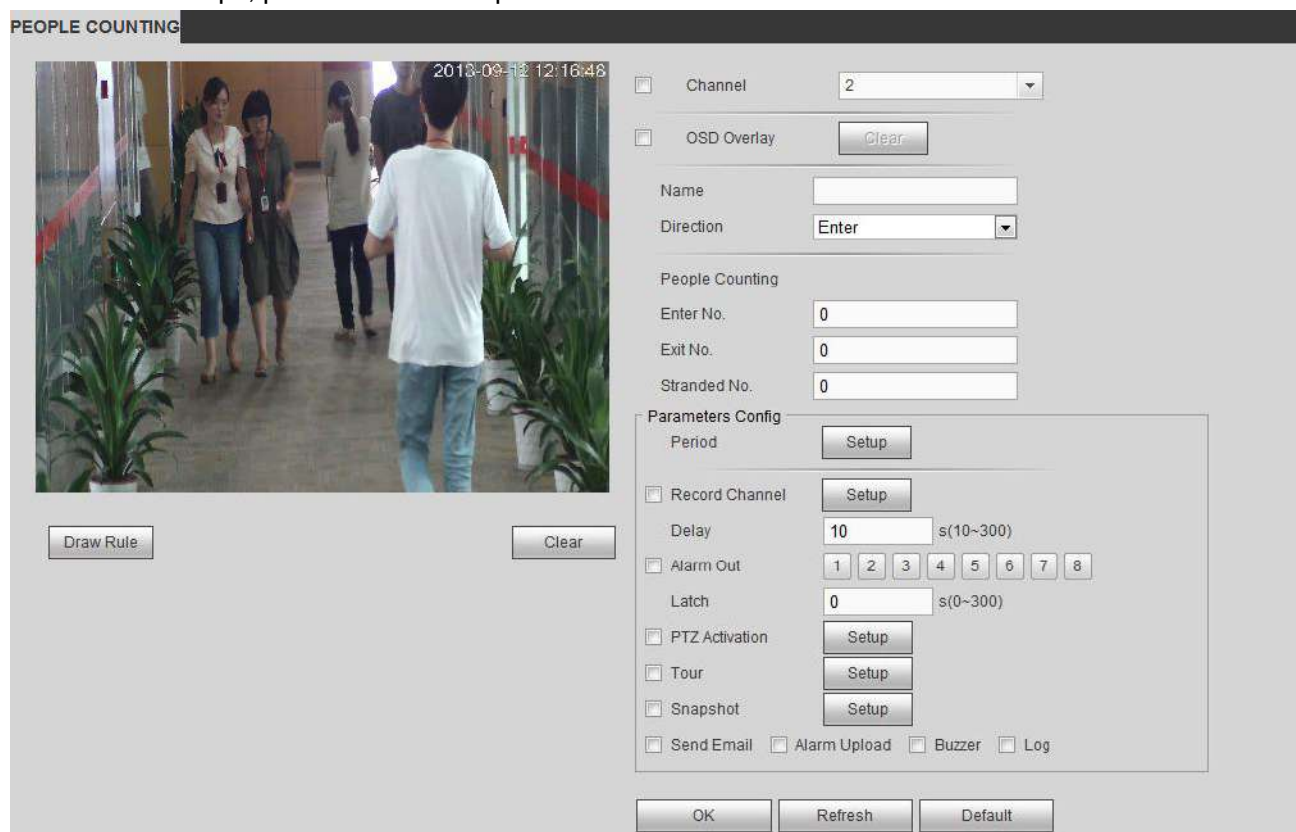

Figure 5-86

5.10.3.5 Heat Map

It is to detect the object activity level in the scene during the specified period.

From main menu->Setup->Event->Heat Map, you can see an interface shown as in Figure 5-87.

For detailed setups, please refer to chapter 5.10.3.1.1 motion detect for detailed information.

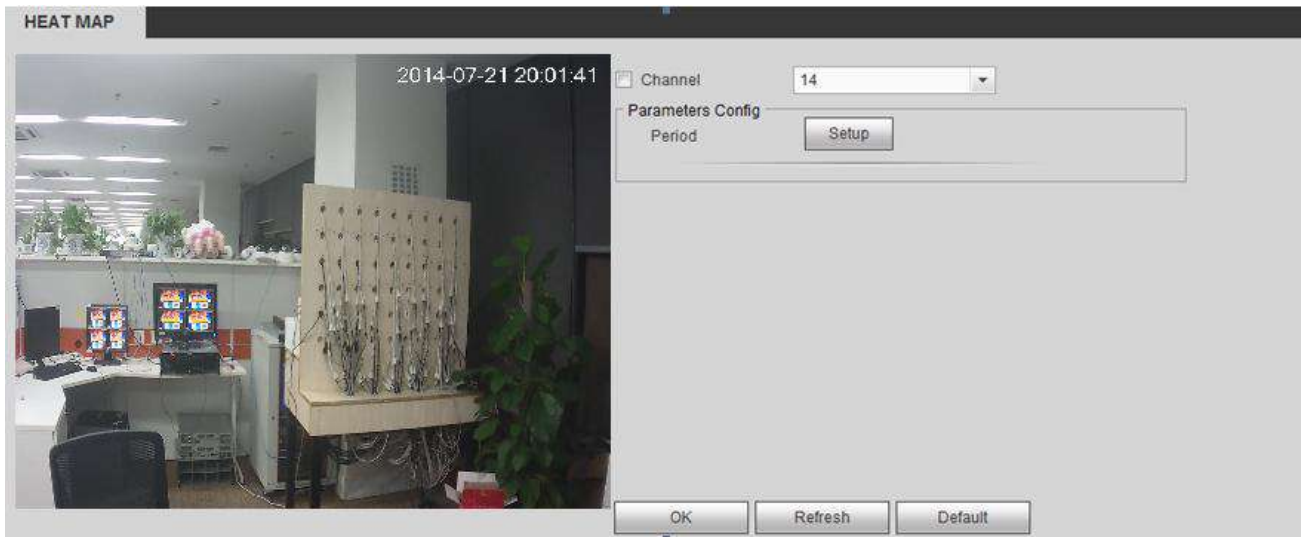

Figure 5-87

5.10.3.6 Audio Detect (Optional)

System can generate an alarm once it detect the audio input is abnormal or audio volume changes.

From main menu->Setup->Event->Audio detect, you can see an interface shown as in Figure 5-88.

- Input abnormal: Check the box here, system can generate an alarm once the audio input is abnormal.
- Intensity change: Check the box here, system can generate an alarm once the audio volume becomes strong.
- Sensitivity: It refers to the audio recognition sensitivity. The higher the value is, the higher the sensitivity is.
- Threshold: It is to set intensity change threshold. The smaller the value is, the higher the sensitivity is.

For detailed setups, please refer to chapter 5.10.3.1.1 motion detect for detailed information.

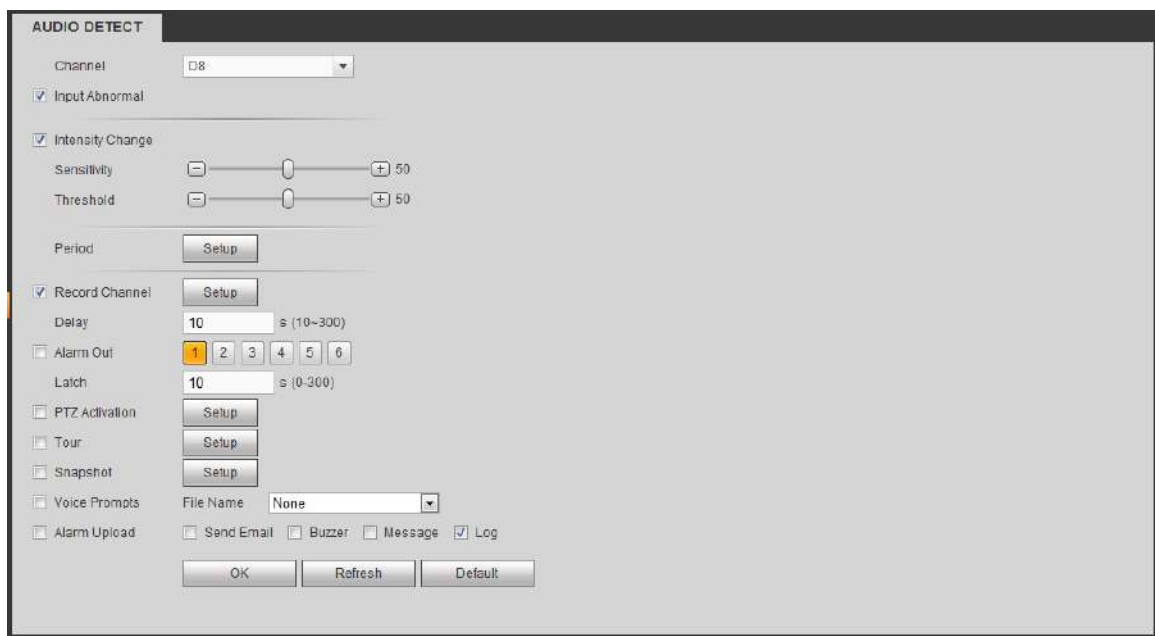

Figure 5-88

5.10.3.7 Alarm

Before operation, please make sure you have properly connected alarm devices such as buzzer. The input mode includes local alarm and network alarm.

5.10.3.7.1 Local Alarm

The local alarm interface is shown as in Figure 5-89. It refers to alarm from the local device.

The screenshot shows a configuration window for 'Local Alarm'. It has four tabs: 'Local Alarm', 'Net Alarm', 'IPC External Alarm', and 'IPC Offline Alarm'. The 'Local Alarm' tab is active. The interface includes the following elements:

- Enable: A dropdown menu showing '1' and an 'Alarm Name' text field.
- Period: A 'Setup' button.
- Anti-Dither: A text field with '5' and 'Sec.(0-600)', and a 'Type' dropdown menu with 'NO' selected.
- Record Channel: A 'Setup' button.
- Delay: A text field with '10' and 'Sec.(10-300)'. Below it is an 'Alarm Out' section with six buttons labeled 1 through 6; button 1 is highlighted in yellow.
- Latch: A text field with '10' and 'Sec.(0-300)'. Below it are three 'Setup' buttons for 'PTZ Activation', 'Tour', and 'Snapshot'.
- Voice Prompts: A 'File Name' dropdown menu with 'None' selected.
- Show Message: A group of checkboxes for 'Send Email', 'Alarm Upload', 'Buzzer', 'Message', and 'Log' (which is checked).
- Buttons at the bottom: 'Copy', 'OK', 'Refresh', and 'Default'.

Figure 5-89

The screenshot shows a 'Setup' dialog box with a close button (X) in the top right corner. It contains the following elements:

- A dropdown menu showing 'Thursday' and a 'Copy' button.
- A table of time ranges for each day of the week. The first row is checked with a green checkmark.
- 'Save' and 'Cancel' buttons at the bottom.

Day	Start Time	End Time	Selected
Thursday	00 : 00	24 : 00	<input checked="" type="checkbox"/>
Friday	00 : 00	24 : 00	<input type="checkbox"/>
Saturday	00 : 00	24 : 00	<input type="checkbox"/>
Sunday	00 : 00	24 : 00	<input type="checkbox"/>
Monday	00 : 00	24 : 00	<input type="checkbox"/>
Tuesday	00 : 00	24 : 00	<input type="checkbox"/>
Wednesday	00 : 00	24 : 00	<input type="checkbox"/>

Figure 5-90

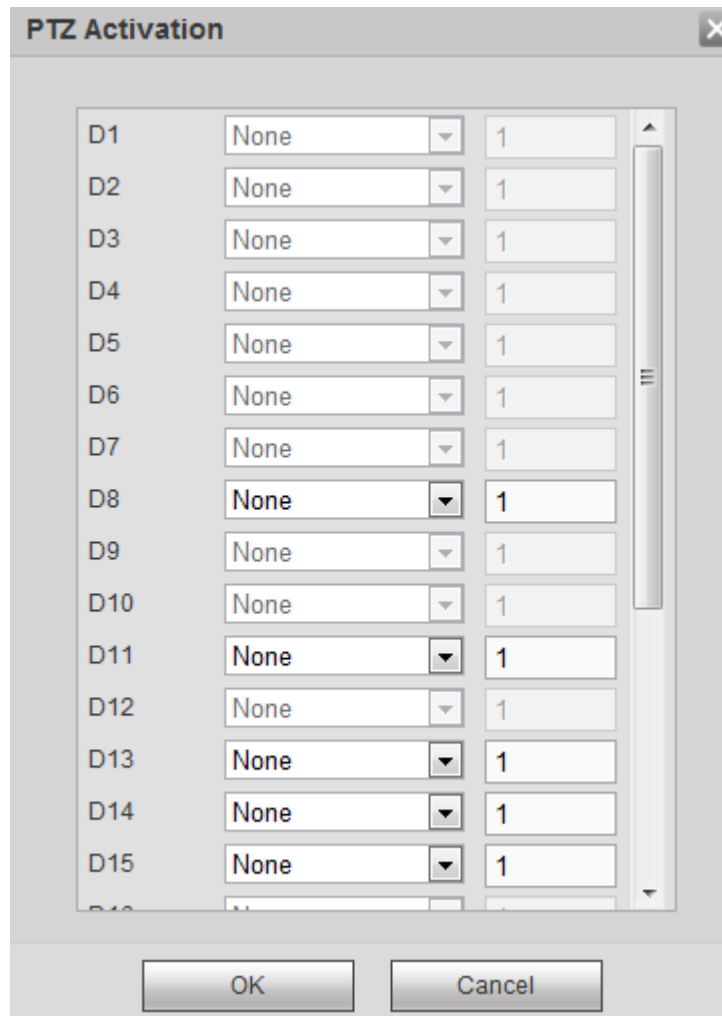

Figure 5-91

Please refer to the following sheet for detailed information.

Parameter	Function
Enable	You need to check the box to enable this function. Please select a channel from the dropdown list.
Period	This function becomes activated in the specified periods. There are six periods in one day. Please draw a circle to enable corresponding period. Select date. If you do not select, current setup applies to today only. You can select all week column to apply to the whole week. Click OK button, system goes back to local alarm interface, please click save button to exit.
Anti-dither	System only memorizes one event during the anti-dither period. The value ranges from 5s to 600s.
Sensor type	There are two options: NO/NC.
Record channel	System auto activates motion detection channel(s) to record once an alarm occurs. Please note you need to set alarm record period and go to Storage-> Schedule to set

Parameter	Function
	current channel as schedule record.
Record Delay	System can delay the record for specified time after alarm ended. The value ranges from 10s to 300s.
Alarm out	Enable alarm activation function. You need to select alarm output port so that system can activate corresponding alarm device when an alarm occurs.
Latch	System can delay the alarm output for specified time after an alarm ended. The value ranges from 1s to 300s.
Show message	System can pop up a message to alarm you in the local host screen if you enabled this function.
Buzzer	Check the box here to enable this function. The buzzer beeps when an alarm occurs.
Alarm upload	System can upload the alarm signal to the center (Including alarm center).
Send Email	If you enabled this function, System can send out an email to alert you when an alarm occurs.
Tour	You need to click setup button to select tour channel. System begins 1-window or multiple-window tour display among the channel(s) you set to record when an alarm occurs. See Figure 5-63.
PTZ Activation	Here you can set PTZ movement when alarm occurs. Such as go to preset X. See Figure 5-91.
Snapshot	Click setup button to select snapshot channel. See Figure 5-64.

5.10.3.7.2 Net Alarm

The network alarm interface is shown as in Figure 5-92.

Network alarm refers to the alarm signal from the network. System does not anti-dither and sensor type setup. For setup information, please refer to chapter 5.10.3.7.1.

Figure 5-92

5.10.3.7.3 IPC external alarm

The IPC external alarm interface is shown as in Figure 5-93.

Network alarm refers to the alarm signal from the network. System does not anti-dither and sensor type setup. For setup information, please refer to chapter 5.10.3.7.1.

Figure 5-93

5.10.3.7.4 IPC Offline Alarm

The IPC offline alarm interface is shown as in Figure 5-94.

System can generate an alarm once the network camera is offline. For setup information, please refer to chapter 5.10.3.7.1.

The screenshot shows a web-based configuration interface for an IPC Offline Alarm. At the top, there are four tabs: 'Local Alarm', 'Net Alarm', 'IPC External Alarm', and 'IPC Offline Alarm', with the last one being selected. The interface includes several configuration options: a checked 'Channel' dropdown set to 'D8'; a 'Record Channel' checkbox with a 'Setup' button; a 'Delay' input field set to '10' with a range of 'Sec.(10~300)'; an 'Alarm Out' section with a row of buttons numbered 1 to 6, where button 1 is highlighted; a 'Latch' input field set to '10' with a range of 'Sec.(0~300)'; checkboxes for 'PTZ Activation', 'Tour', and 'Snapshot', each with a 'Setup' button; a 'Voice Prompts' section with a 'File Name' dropdown set to 'None'; and a 'Show Message' section with checkboxes for 'Send Email', 'Alarm Upload', 'Buzzer', 'Message', and 'Log' (which is checked). At the bottom, there are four buttons: 'Copy', 'OK', 'Refresh', and 'Default'.

Figure 5-94

5.10.3.8 Abnormality

From main menu->Setup->Event->Abnormality, it includes four types: HDD/Network/User/Device. See Figure 5-95 through Figure 5-98.

The screenshot shows a web-based configuration interface for an HDD Abnormality event. At the top, there are three tabs: 'HDD', 'Network', and 'Username', with 'HDD' being selected. The interface includes several configuration options: an 'Event Type' dropdown set to 'No HDD'; a checked 'Enable' checkbox; an 'Alarm Out' section with a row of buttons numbered 1 to 6, where button 1 is highlighted; a 'Latch' input field set to '10' with a range of 'Sec.(0~300)'; a 'Voice Prompts' section with a 'File Name' dropdown set to 'None'; and a 'Show Message' section with checkboxes for 'Send Email', 'Alarm Upload', 'Buzzer', 'Message', and 'Log' (which is checked). At the bottom, there are two buttons: 'OK' and 'Refresh'.

Figure 5-95

HDD	Network	User	Device
Event Type: Disconnect			
<input checked="" type="checkbox"/> Enable			
<input type="checkbox"/> Record Channel	1 2 3 4 5 6 7 8 9 10 11 12 13 14 15 16		
Delay	10 sec.(10~300)		
<input type="checkbox"/> Alarm Out	1 2 3 4 5 6		
Latch	10 sec.(0~300)		
<input type="checkbox"/> Voice Prompts	File Name	None	
<input type="checkbox"/> Show Message	<input type="checkbox"/> Send Email	<input type="checkbox"/> Buzzer	
<input type="checkbox"/> Message	<input checked="" type="checkbox"/> Log		
Save		Refresh	

Figure 5-96

HDD	Network	Username
Event Type: Disconnect		
<input checked="" type="checkbox"/> Enable		
<input type="checkbox"/> Alarm Out	1 2 3 4 5 6	
Latch	10 Sec.(0~300)	
<input type="checkbox"/> Voice Prompts	File Name	None
<input type="checkbox"/> Show Message	<input type="checkbox"/> Send Email	<input type="checkbox"/> Buzzer <input type="checkbox"/> Message <input checked="" type="checkbox"/> Log
OK		Refresh

Figure 5-97

Figure 5-98

Please refer to the following sheet for detailed information.

Parameter	Function
Event Type	The abnormal events include: HDD: No disk, disk error, disk no space; <ul style="list-style-type: none"> ● Network: Net disconnection, IP conflict, MAC conflict. ● User: Illegal login. ● Device: Temperature is too high, fan speed is abnormal. Please note this function is for some series product only. ● You can set one or more items here. ● Less than: You can set the minimum percentage value here. The device can generate an alarm when capacity is not sufficient. This item is for disk no space type only.
Enable	Check the box here to enable selected function.
Alarm Out	Please select corresponding alarm output channel when an alarm occurs. You need to check the box to enable this function.
Latch	The alarm output can delay for the specified time after an alarm stops. The value ranges from 0s to 300s. The default setup is 10 seconds. The 0 second means there is no delaying time.
Attempt(s)	It is to set login attempt times. Once the login attempt exceeds the threshold you set here, current account will be locked. This function is for illegal login only.
Lock time	It is to set account lock time once its login attempt has exceeded the threshold you set. This function is for illegal login only.
Show message	System can pop up a message to alarm you in the local host screen if you enabled this function.

Parameter	Function
Alarm upload	System can upload the alarm signal to the center (Including alarm center).
Send Email	If you enabled this function, System can send out an email to alert you when an alarm occurs.
Buzzer	Check the box here to enable this function. The buzzer beeps when an alarm occurs.
Log	Check the box here, system can record the network event alarm log.

5.10.3.9 Alarm Out

The alarm output interface is shown as below. See Figure 5-99

Here you can set alarm output mode: auto/manual/stop.

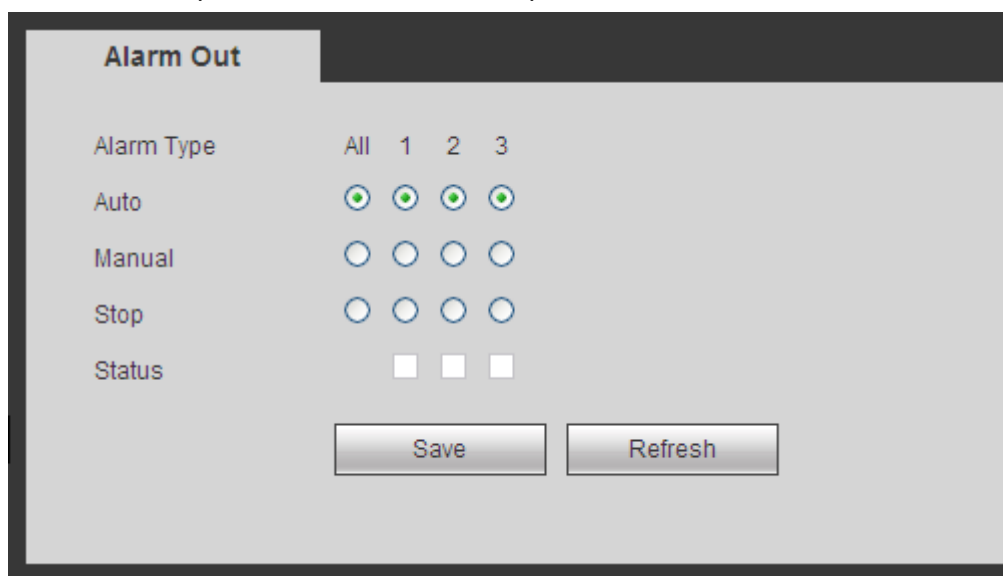

Figure 5-99

5.10.4 Storage

5.10.4.1 Basic

It is to manage HDD storage space.

Step 4 From main menu->Setup->Storage->Basic.

Enter Basic interface. See Figure 5-43.



Figure 5-100

Step 5 Set parameters.

Parameter	Function
HDD full	It is to select working mode when hard disk is full. There are two options: stop recording or rewrite. <ul style="list-style-type: none"> ● Stop: If current HDD is full while there is no idle HDD, then system stops recording, ● Overwrite: If the current HDD is full while there is no idle HDD, then system overwrites the previous files.
Pack duration	It is to specify record duration. The max value is 120 minutes.
Auto delete old files	<ul style="list-style-type: none"> ● Never: Do not auto delete old files. ● Customized: input customized period here, system can auto delete corresponding old files

5.10.4.2 Schedule

In this interface, you can add or remove the schedule record setup. See Figure 5-101.

There are four record modes: general (auto), motion detect, alarm and MD&alarm. There are six periods in one day.

You can view the current time period setup from the color bar.

- Green color stands for the general record/snapshot.
- Yellow color stands for the motion detect record/snapshot.
- Red color stands for the alarm record/snapshot.
- Blue color stands for MD&alarm record/snapshot.

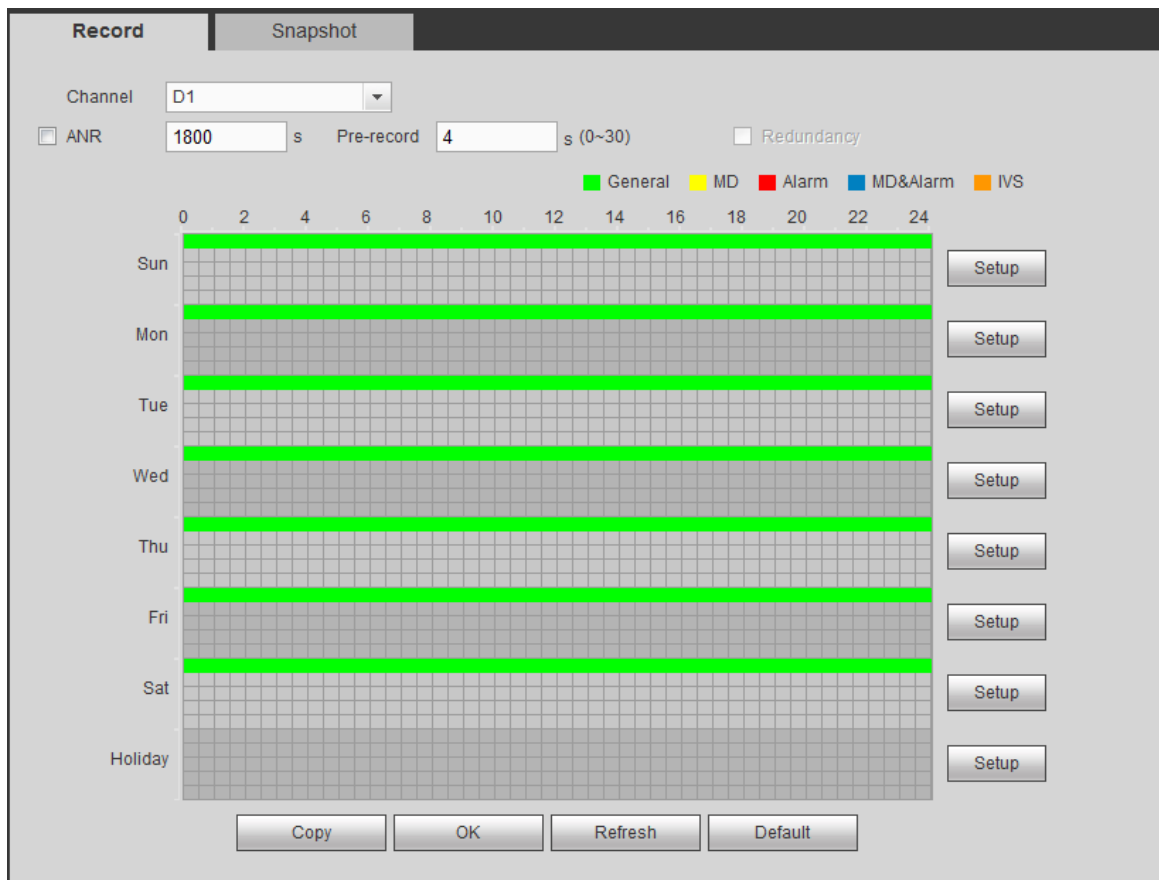

Figure 5-101

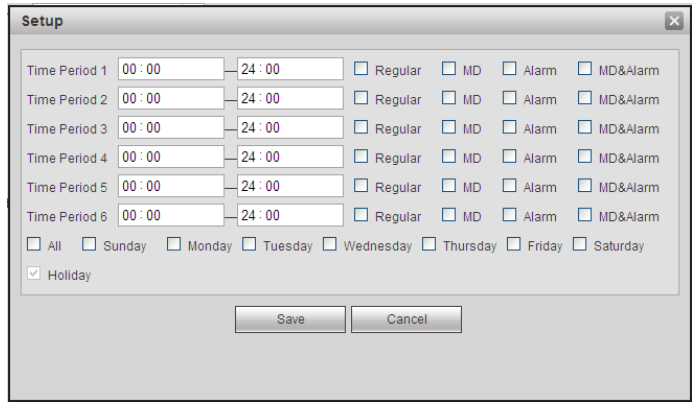

Figure 5-102

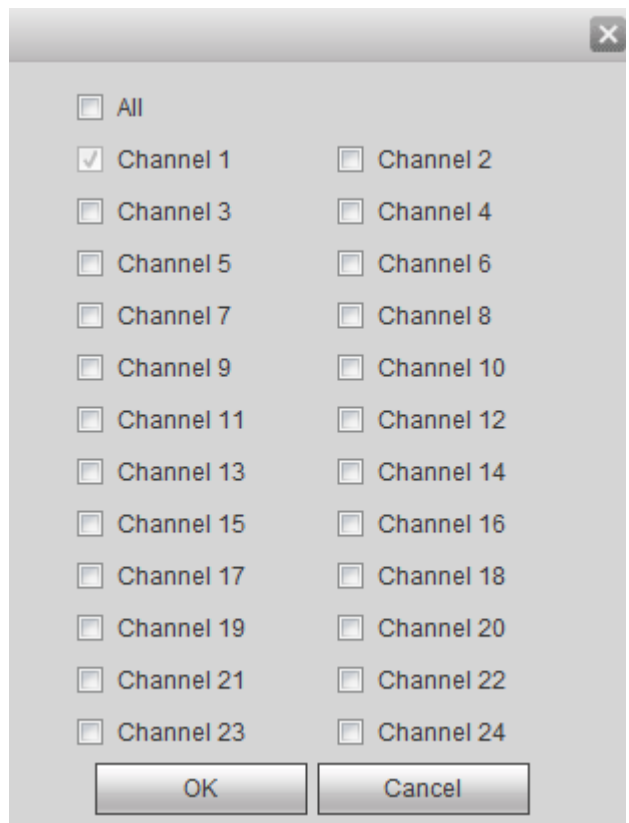

Figure 5-103

Please refer to the following sheet for detailed information.

Parameter	Function
Channel	Please select a channel from the dropdown list.
Pre-record	Please input pre-record time here. The value ranges from 0 to 30.
Redundancy	Check the box here to enable redundancy function. Please note this function is null if there is only one HDD.
Snapshot	Check the box here to enable snapshot function.
Holiday	Check the box here to enable holiday function.
Setup	Click the Setup button, you can set record period. See Figure 5-102. There are six periods in one day. If you do not check the date at the

Parameter	Function
	bottom of the interface, current setup is for today only. Please click Save button and then exit.
Copy	Copy function allows you to copy one channel setup to another. After setting in channel, click Copy button, you can go to interface Figure 5-103. You can see current channel name is grey such as channel 1. Now you can select the channel you want to paste such as channel 5/6/7. If you want to save current setup of channel 1 to all channels, you can click the first box "ALL". Click the OK button to save current copy setup. Click the OK button in the Encode interface, the copy function succeeded.

5.10.4.3 HDD Manager

5.10.4.3.1 Local Storage

The local interface is shown as in Figure 5-104. Here you can see HDD information. You can also operate the read-only, read-write, redundancy (if there are more than on HDD) and format operation.

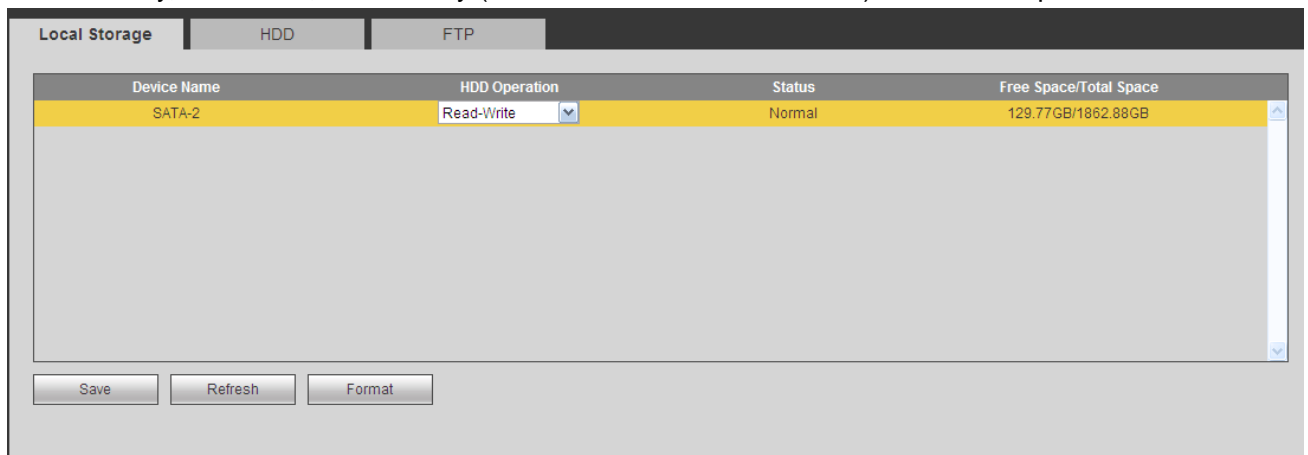

Figure 5-104

5.10.4.3.2 HDD

The HDD interface is to set HDD group. See Figure 5-105.

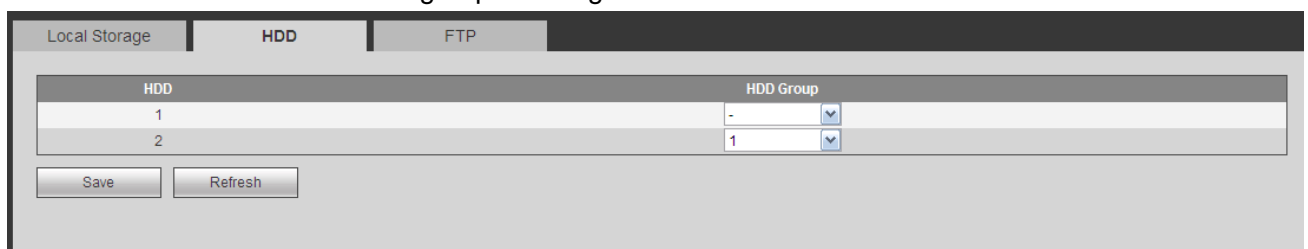

Figure 5-105

5.10.4.3.3 FTP

The FTP interface is to set FTP information. See Figure 5-106.

Please set the FTP as your remote storage location. System can save record file or snapshot picture to the FTP once the network is offline or malfunction.

Local Storage	HDD	FTP
<input checked="" type="checkbox"/> Enable		
Host IP	0 . 0 . 0 . 0 *	
Port	21 *	
User Name	<input type="text"/>	
Password	<input type="text"/>	<input type="checkbox"/> Anonymous
Remote Directory	<input type="text"/>	
File Length	0	M
Image Upload Interval	2	Second
Channel	1	
Weekday	Tuesday	
Period 1	00 : 00 - 24 : 00	<input type="checkbox"/> Alarm <input type="checkbox"/> MD <input type="checkbox"/> Regular
Period 2	00 : 00 - 24 : 00	<input type="checkbox"/> Alarm <input type="checkbox"/> MD <input type="checkbox"/> Regular
<input type="button" value="Test"/> <input type="button" value="Save"/> <input type="button" value="Refresh"/> <input type="button" value="Default"/>		

Figure 5-106

5.10.4.4 Record Control

The interface is shown as in Figure 5-107.

Record		All	D8	D11	D13	D14	D15	D17	D18	D19	D20	D21	D22	D23	D24
Main Stream															
Auto		<input checked="" type="radio"/>	<input checked="" type="radio"/>	<input checked="" type="radio"/>	<input checked="" type="radio"/>	<input checked="" type="radio"/>	<input checked="" type="radio"/>	<input checked="" type="radio"/>	<input checked="" type="radio"/>	<input checked="" type="radio"/>	<input checked="" type="radio"/>	<input checked="" type="radio"/>	<input checked="" type="radio"/>	<input checked="" type="radio"/>	<input checked="" type="radio"/>
Manual		<input type="radio"/>	<input type="radio"/>	<input type="radio"/>	<input type="radio"/>	<input type="radio"/>	<input type="radio"/>	<input type="radio"/>	<input type="radio"/>	<input type="radio"/>	<input type="radio"/>	<input type="radio"/>	<input type="radio"/>	<input type="radio"/>	<input type="radio"/>
Stop		<input type="radio"/>	<input type="radio"/>	<input type="radio"/>	<input type="radio"/>	<input type="radio"/>	<input type="radio"/>	<input type="radio"/>	<input type="radio"/>	<input type="radio"/>	<input type="radio"/>	<input type="radio"/>	<input type="radio"/>	<input type="radio"/>	<input type="radio"/>
Sub Stream1															
Auto		<input type="radio"/>	<input type="radio"/>	<input type="radio"/>	<input type="radio"/>	<input type="radio"/>	<input type="radio"/>	<input type="radio"/>	<input type="radio"/>	<input type="radio"/>	<input type="radio"/>	<input type="radio"/>	<input type="radio"/>	<input type="radio"/>	<input type="radio"/>
Manual		<input type="radio"/>	<input type="radio"/>	<input type="radio"/>	<input type="radio"/>	<input type="radio"/>	<input type="radio"/>	<input type="radio"/>	<input type="radio"/>	<input type="radio"/>	<input type="radio"/>	<input type="radio"/>	<input type="radio"/>	<input type="radio"/>	<input type="radio"/>
Stop		<input checked="" type="radio"/>	<input checked="" type="radio"/>	<input checked="" type="radio"/>	<input checked="" type="radio"/>	<input checked="" type="radio"/>	<input checked="" type="radio"/>	<input checked="" type="radio"/>	<input checked="" type="radio"/>	<input checked="" type="radio"/>	<input checked="" type="radio"/>	<input checked="" type="radio"/>	<input checked="" type="radio"/>	<input checked="" type="radio"/>	<input checked="" type="radio"/>
Sub Stream2															
Auto		<input type="radio"/>	<input type="radio"/>	<input type="radio"/>	<input type="radio"/>	<input type="radio"/>	<input type="radio"/>	<input type="radio"/>	<input type="radio"/>	<input type="radio"/>	<input type="radio"/>	<input type="radio"/>	<input type="radio"/>	<input type="radio"/>	<input type="radio"/>
Manual		<input type="radio"/>	<input type="radio"/>	<input type="radio"/>	<input type="radio"/>	<input type="radio"/>	<input type="radio"/>	<input type="radio"/>	<input type="radio"/>	<input type="radio"/>	<input type="radio"/>	<input type="radio"/>	<input type="radio"/>	<input type="radio"/>	<input type="radio"/>
Stop		<input checked="" type="radio"/>	<input checked="" type="radio"/>	<input checked="" type="radio"/>	<input checked="" type="radio"/>	<input checked="" type="radio"/>	<input checked="" type="radio"/>	<input checked="" type="radio"/>	<input checked="" type="radio"/>	<input checked="" type="radio"/>	<input checked="" type="radio"/>	<input checked="" type="radio"/>	<input checked="" type="radio"/>	<input checked="" type="radio"/>	<input checked="" type="radio"/>
Snapshot															
Open		<input type="radio"/>	<input type="radio"/>	<input type="radio"/>	<input type="radio"/>	<input type="radio"/>	<input type="radio"/>	<input type="radio"/>	<input type="radio"/>	<input type="radio"/>	<input type="radio"/>	<input type="radio"/>	<input type="radio"/>	<input type="radio"/>	<input type="radio"/>
Stop		<input checked="" type="radio"/>	<input checked="" type="radio"/>	<input checked="" type="radio"/>	<input checked="" type="radio"/>	<input checked="" type="radio"/>	<input checked="" type="radio"/>	<input checked="" type="radio"/>	<input checked="" type="radio"/>	<input checked="" type="radio"/>	<input checked="" type="radio"/>	<input checked="" type="radio"/>	<input checked="" type="radio"/>	<input checked="" type="radio"/>	<input checked="" type="radio"/>
		<input type="button" value="OK"/>		<input type="button" value="Refresh"/>											

Figure 5-107

Please refer to the following sheet for detailed information.

Parameter	Function
Channel	Here you can view channel number. The number displayed here is the max channel amount of your device.
Status	There are three statuses: schedule, manual and stop.
Schedule	System enables auto record function as you set in record schedule setup (general, motion detect and alarm).
Manual	It has the highest priority. Enable corresponding channel to record no matter what period applied in the record setup.
Stop	Stop current channel record no matter what period applied in the record setup.
Start all/ stop all	Check the corresponding All button, you can enable or disable all channels record.

5.10.4.5 RAID Manager

Important

Please make sure your purchased product support the RAID function, otherwise you cannot see the following interface.

RAID (redundant array of independent disks) is a data storage virtualization technology that combines multiple physical HDD components into a single logical unit for the purposes of data redundancy, performance improvement, or both.



Note

- RAID function is for some series product only. Slight difference may be found on the user interface.
- Right now, NVR supports RAID0, RAID1, RAID5, RAID6, and RAID 10. Local hotspare supports RAID1, RAID5, RAID6, and RAID10.
- Refer to the following table for detailed information.

RAID Type	HDD Amount
RAID0	At least 2 HDDs.
RAID1	Only 2 HDDs.
RAID5	At least 3 HDDs. Usually recommend the RAID5 consists of 4 to 6 HDDs.
RAID6	At least 4 HDDs.
RAID10	At least 4 HDDs.

5.10.4.5.1 RAID Config

It is for you to manage RAID HDD. It can display RAID name, type, free space, total space, status and etc. Here you can add/delete RAID HDD.

Click Add button to select RAID type and then select HDDs, click OK button to add. See Figure 5-108.

One click to create RAID

- Click it to automatically create RAID5.
- For create RAID function, you can select the physical HDD that does not included in the RAID group or the created disk array to create a RAID5. You can refer to the following situations:
- There is no RAID, no hotspare disk: System directly creates the RAID5 and creates one hotspare disk at the same time.

- There is no RAID, but there is a hotspare disk: System creates the RAID5 only. It uses previous hotspare disk.
- There is RAID: System cancel the previous RAID setup and then create the new RAID5. System creates the hotspare disk if there is no one. System uses previous hotspare disk if there is hotspare disk available.
- The background will format the virtual disk.

Create manually

Step 4 Select RAID type first and then follow the prompts to set HDD amount.

Step 5 Click Create Manually button, system pops up dialogue box to warning you it is going to clear all data.

Step 6 Click OK button to complete the operation.



Note

Click  to delete RAID.

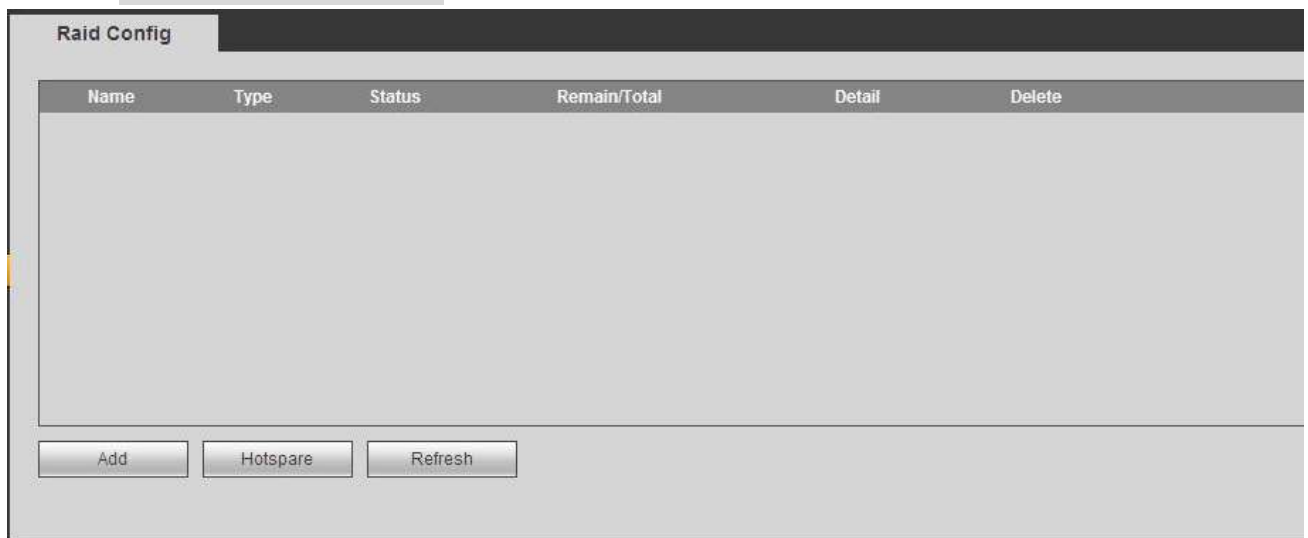

Figure 5-108

5.10.4.5.2 Hotspare disks

In Figure 5-108, click hotspare button, you can add the hot spare HDD. See Figure 5-109. The type includes two options:

- Global: It is global hotspare disk. When any RAID becomes degrading, it can replace and build the RAID.
- Local: It is local hotspare disk. When the specified RAID becomes degrading, it can replace and build the RAID.

Select a hot spare device and then click Delete button. Click Apply button to delete.

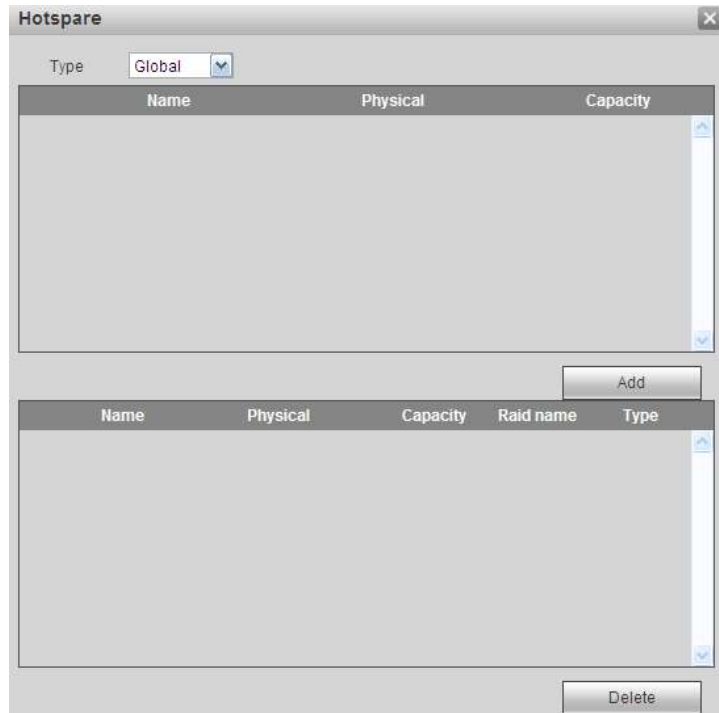

Figure 5-109

5.10.4.6 Storage

5.10.4.6.1 Main Stream

The main stream interface is shown as in Figure 5-110. Here you can set corresponding HDD group to save main stream.

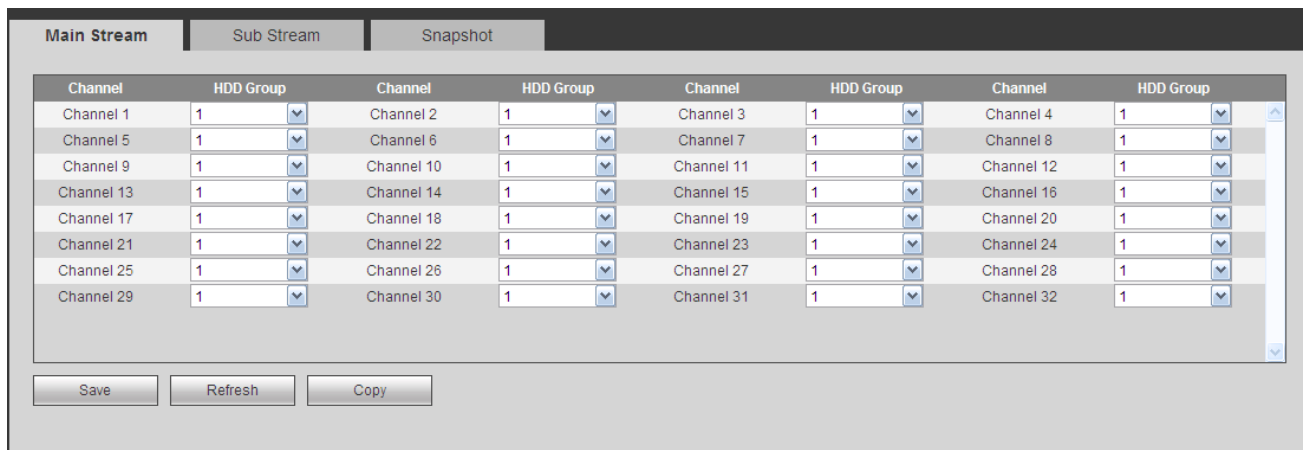

Figure 5-110

5.10.4.6.2 Sub Stream

The sub stream interface is shown as in Figure 5-111.

Here you can set corresponding HDD group to save sub stream.

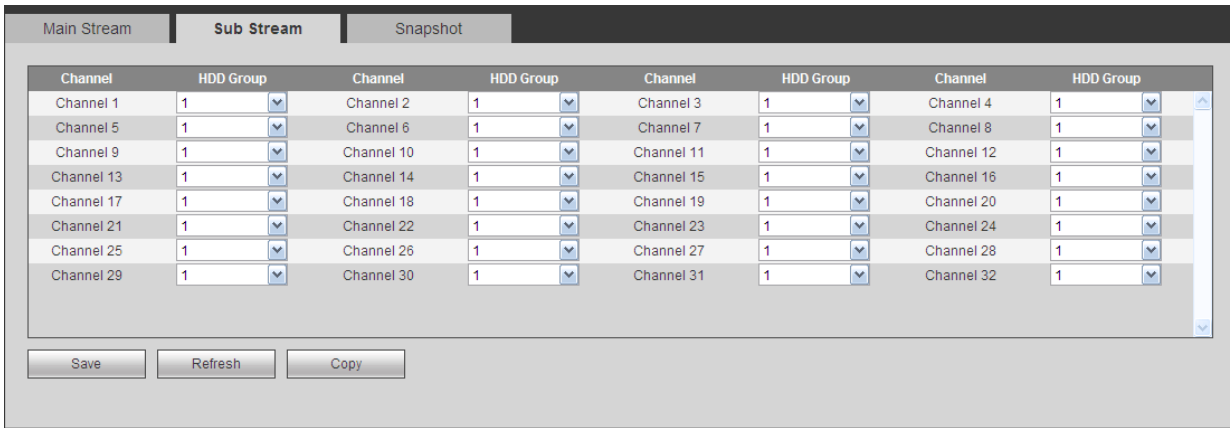

Figure 5-111

5.10.4.6.3 Snapshot

The snapshot interface is shown as in Figure 5-112. Here you can set corresponding HDD group to save snapshot picture.

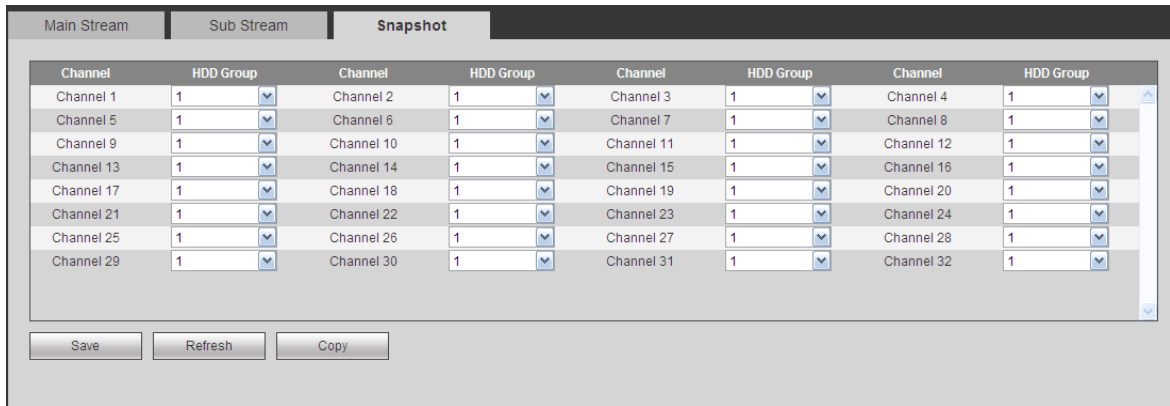

Figure 5-112

5.10.5 Setting

5.10.5.1 General

The general interface includes general, date/time and holiday setup.

5.10.5.1.1 General

The general interface is shown as in Figure 5-113.

Figure 5-113

Please refer to the following sheet for detailed information.

Parameter	Function
Device ID	It is to set device name.
Device No.	It is device channel number.
Language	You can select the language from the dropdown list. Please note the device needs to reboot to get the modification activated.
Video Standard	This is to display video standard such as PAL.
Auto logout	Here is for you to set auto logout interval once login user remains inactive for a specified time. Value ranges from 0 to 60 minutes.
IPC Time Sync	You can input an interval here to synchronize the DVR time and IPC time.
Navigation bar	Check the box here, system displays the navigation bar on the interface.

5.10.5.1.2 Date and time

The date and time interface is shown as in Figure 5-114

Figure 5-114

Please refer to the following sheet for detailed information.

Parameter	Function
Date format	Here you can select date format from the dropdown list.
Time Format	There are two options: 24-H and 12-H.
Time zone	The time zone of the device.
System time	It is to set system time. It becomes valid after you set.
Sync PC	You can click this button to save the system time as your PC current time.
DST	Here you can set day night save time begin time and end time. You can set according to the date format or according to the week format.
NTP	You can check the box to enable NTP function.
NTP server	You can set the time server address.
Port	It is to set the time server port.
Interval	It is to set the sync periods between the device and the time server.

5.10.5.1.3 Holiday Setup

Holiday setup interface is shown as in Figure 5-115.

Here you can click Add holidays box to add a new holiday and then click Save button to save.

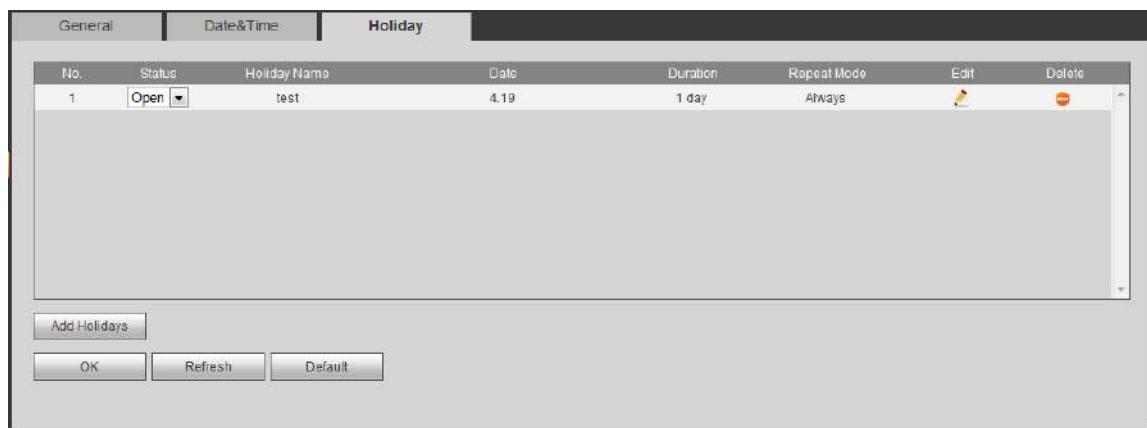

Figure 5-115

5.10.5.2 Display

Display interface includes GUI, TV adjust, Tour and Customized split.

5.10.5.2.1 Display

Here you can set background color and transparency level. See Figure 5-116.

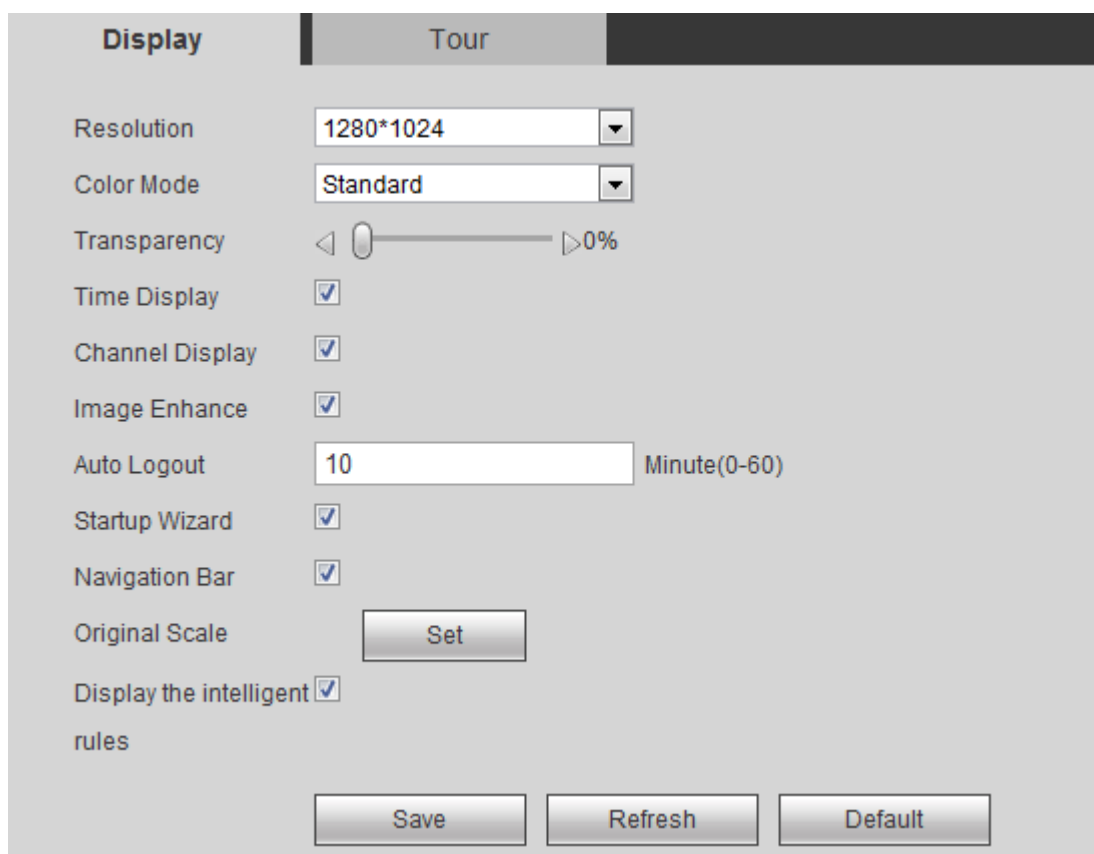

Figure 5-116

Please refer to the following sheet for detailed information.

Parameter	Function
Resolution	There are four options: 1920×1080, 1280×1024(default), 1280×720, 1024×768. Please note the system needs to reboot to activate current setup.

Color mode	Please select from the dropdown list.
Transparency	Here is for you to adjust transparency. The value ranges from 128 to 255.
Time title/channel title	Check the box here, you can view system time and channel number on the monitor video.
Image enhance	Check the box; you can optimize the margin of the preview video.
Startup wizard	Once you check the box here, system will go to the startup wizard directly when the system restarts the next time. Otherwise, it will go to the login interface.
Navigation bar	Check the box here, system displays the navigation bar on the interface.
Original scale	Click the Set button to select a channel, it can restore original scale.
Auto logout	Here is for you to set auto logout interval once login user remains inactive for a specified time. Value ranges from 0 to 60 minutes. 0 means there is no standby time. After the auto logout, the user needs to input user name and password to login again.
Display intelligent rule(s)	Check the box to enable IVS function, system can display IVS rule on the preview interface.

5.10.5.2.2 Tour

The tour interface is shown as in Figure 5-117. Here you can set tour interval, split mode, motion detect tour and alarm tour mode.

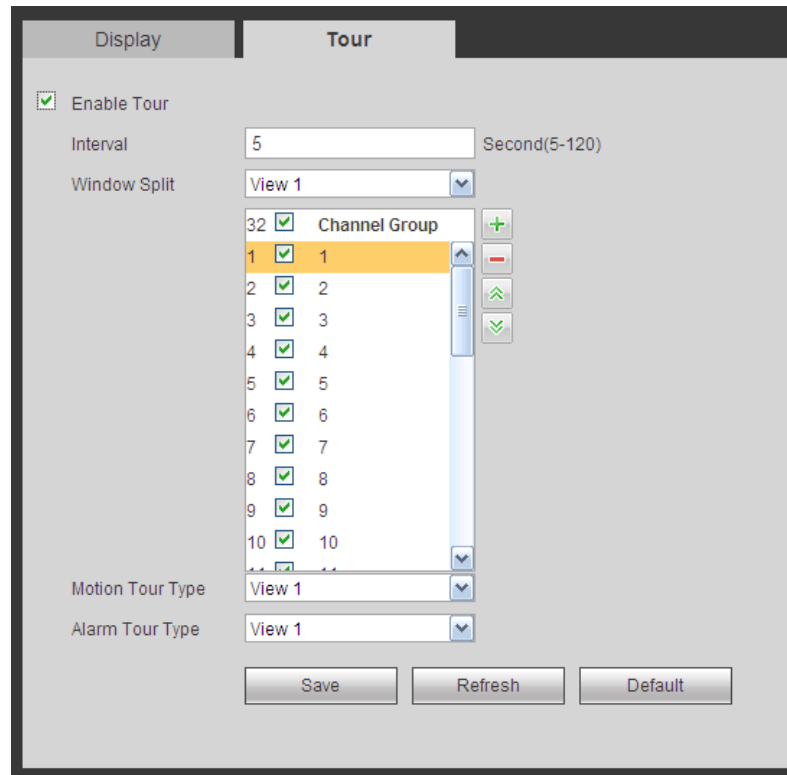

Figure 5-117

Please refer to the following sheet for detailed information.

Parameter	Function
Enable tour	Check the box here to enable tour function.
Interval	Here is for you to adjust transparency. The value ranges from 5 to 120s. The default setup is 5s.
Split	Here you can set window mode and channel group. System can support 1/4/8/9/16/25/36-window according to device channel amount.
Motion tour/Alarm tour	Here you can set motion detect tour/alarm tour window mode. System supports 1/8-window now.

5.10.5.2.1 Custom Split

From main menu->Setup->System->Display->Custom split, the interface is shown as in Figure 5-118. Here you can set customized split mode.

Note

- This function is for some series products. Please refer to the actual product for detailed information.
- Device max supports 5 customized videos.

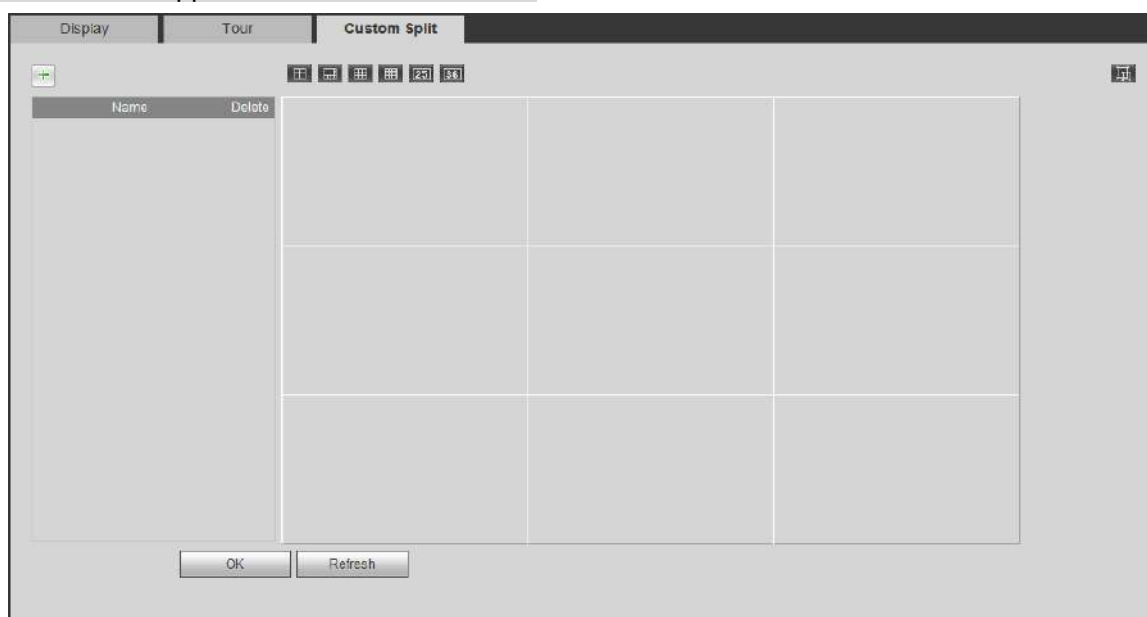



Figure 5-118

Click  and then click  to select basic mode

In regular mode, drag the mouse in the preview frame, you can merge several small windows to one window so that you can get you desired split mode.

After the setup, the selected window has the red frame.

Select the merging window, the frame is red; you can click  to cancel the merge to restore regular mode.

Click OK to exit.

5.10.5.3 RS232

The RS232 interface is shown as in Figure 5-119.

Figure 5-119

Please refer to the following sheet for detailed information.

Parameter	Function
Protocol	Select the corresponding dome protocol. Default setup is console.
Baud Rate	Select the baud rate. Default setup is 115200.
Data Bit	The value ranges from 5 to 8. Default setup is 8.
Stop bit	There are two options: 1/2. Default setup is 1.
Parity	There are five options: none/odd/even/space/mark. Default setup is none.

5.10.5.4 PTZ

The PTZ interface is shown as in Figure 5-120 (Local) and Figure 5-121 (Remote).

Before setup, please check the following connections are right:

- PTZ and decoder connection is right. Decoder address setup is right.
- Decoder A (B) line connects with NVR A (B) line.

Click Save button after you complete setup, you can go back to the monitor interface to control speed dome.

PTZ

Channel: 2

PTZ Type: Local

Protocol: PELCOD

Address: 1

Baud Rate: 9600

Data Bit: 8

Stop Bit: 1

Parity: None

Copy Save Refresh Default

Figure 5-120

PTZ

Channel: 1

PTZ Type: Remote

Copy Save Refresh Default

Figure 5-121

Please refer to the following sheet for detailed information.

Parameter	Function
Channel	Select speed dome connected channel.
PTZ Type	There are two options: local/remote. Please select remote type if you are connecting to the network PTZ. Please select local type if you are using RS485 to the PTZ camera.
Protocol	Select the corresponding dome protocol such as PELCOD.
Address	Set corresponding dome address. Default value is 1. Please note your setup here shall comply with your dome address; otherwise you cannot control the speed dome.
Baud Rate	Select the dome baud rate. Default setup is 9600.
Data Bit	The value ranges from 5 to 8. Default setup is 8. Please set according to the speed dome dial switch setup.

Parameter	Function
Stop bit	The value ranges from 1 to 2. Default setup is 1. Please set according to the speed dome dial switch setup.
Parity	The options include non/odd/even/space/null. Default setup is none. Please set according to the speed dome dial switch setup.

5.10.5.5 POS

Connect the NVR to the POS, it can receive the POS information and overlay on the corresponding record.

Note

POS info overlay and playback function is for 1-window only.

From main menu->Setting->System->POS, you can go to the following interface. See Figure 5-122.



Figure 5-122

Click Add, you can see the following dialogue box. See Figure 5-123.

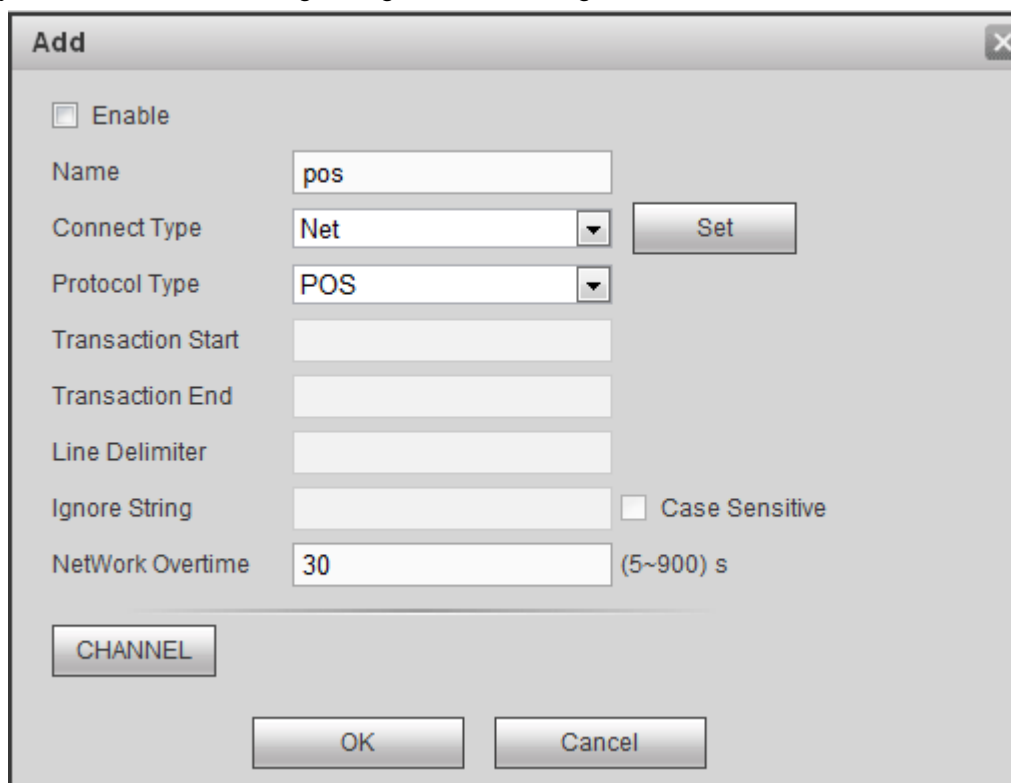

Figure 5-123

Check the box to enable POS function, Click Set button; you can see the following interface. See Figure 5-124.

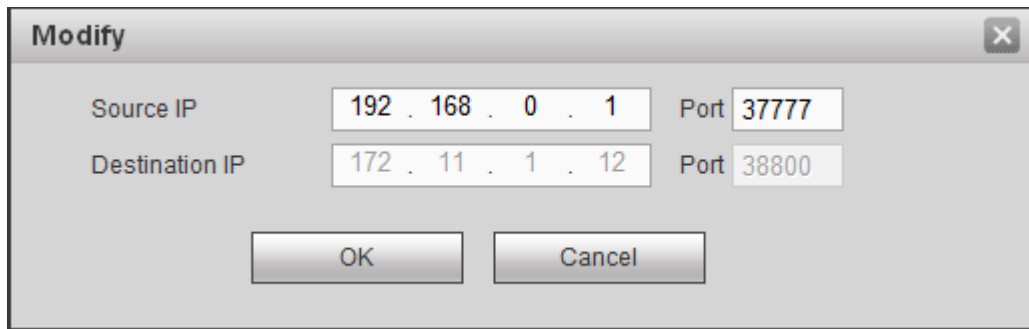

Figure 5-124

Set source IP and destination IP, and then click OK. System goes back to Figure 5-123.

- Source IP: POS device IP address.
- Destination IP: NVR IP address.

In Figure 5-123, click Channel Set button, select the channel you want to overlay POS information. Click OK button to complete the setup.

Tips



: Click it to delete POS setup.



: Click it to change setup information.

5.10.5.6 Voice

The audio function is to manage audio files and set schedule play function. It is to realize audio broadcast activation function.

5.10.5.6.1 File List

From main menu->Setup->System->Voice->File list, here you can add audio file, or delete audio file. See Figure 5-125.

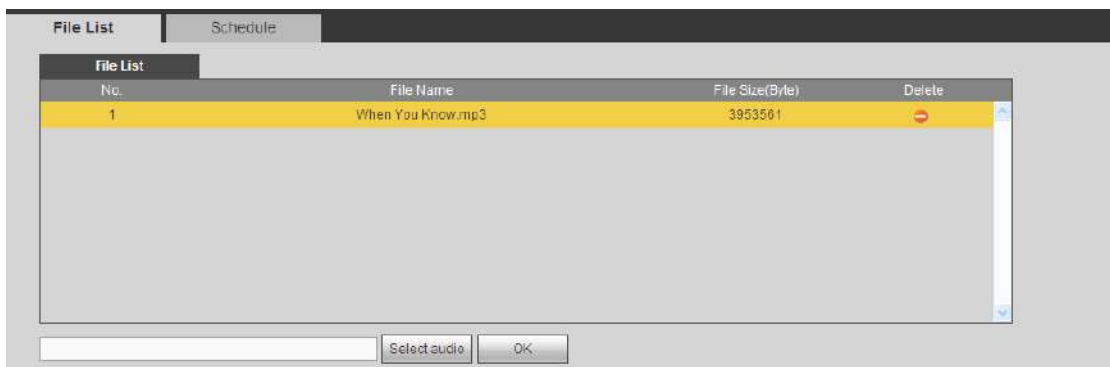

Figure 5-125

Click Add button, you can add audio file and import the audio file via the local computer. See Figure 5-126.

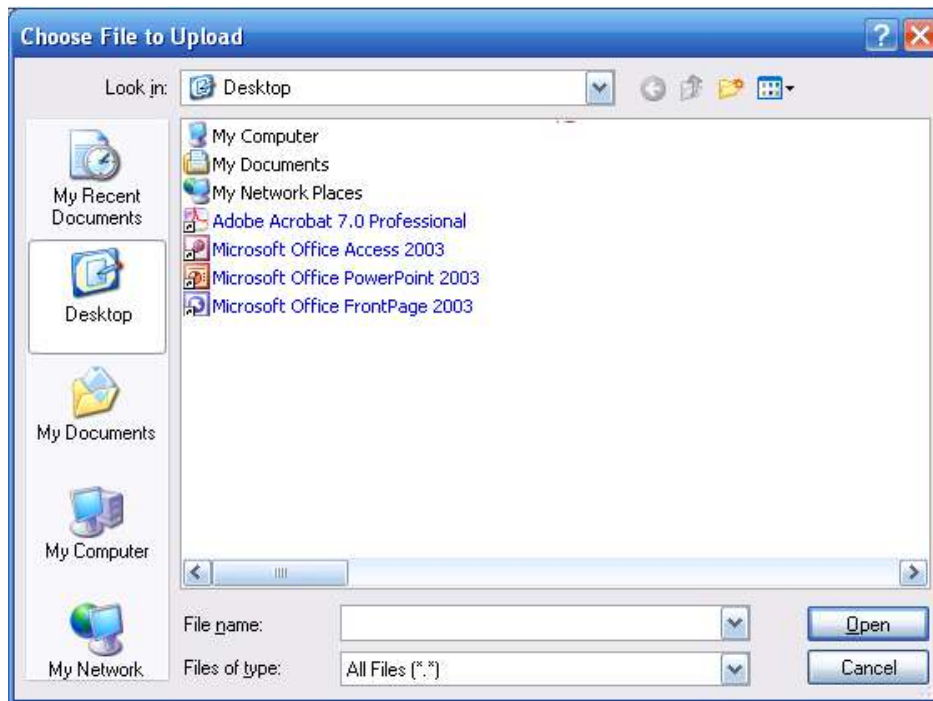

Figure 5-126

5.10.5.6.2 Schedule

It is to set schedule broadcast function. You can play the different audio files in the specified periods. From main menu->Setup->System->Voice->.Schedule, you can see the following interface. See Figure 5-127.

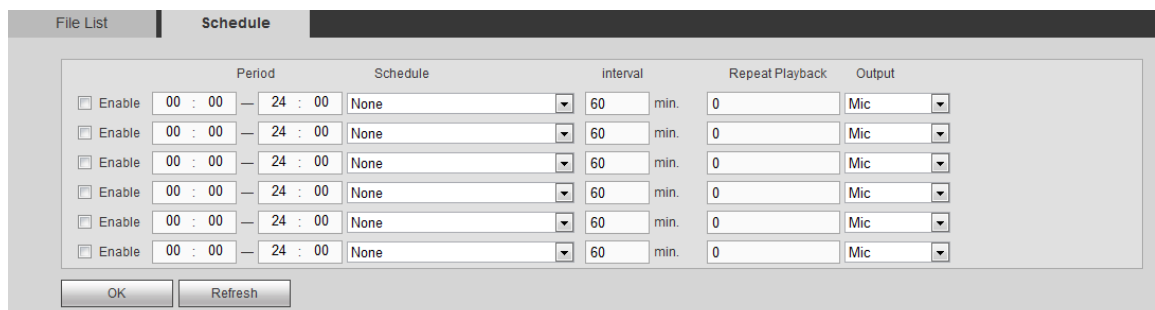

Figure 5-127

Please refer to the following sheet for detailed information.

Parameter	Function
Period	There are six periods. Check the box to enable current setup.
Repeat	It is to set audio file repeat times in the specified period.
Interval	It is the audio file repeated interval in the specified period.
Output port	There are two options: MIC (default)/audio. When reuse the MIC port and bidirectional talk port, the bidirectional port has the higher priority. Please note some series product does not support audio function.



Note

- The audio file end time depends on the audio file size and the interval setup.
- Priority: Bidirectional talk>Event trigger alarm>Trial listening>Audio schedule broadcast.

5.10.5.7 Account



Note

- For the user name, the string max length is 31-byte, and for the user group, the string max length is 15-byte. The user name can only contain English letters, numbers and “_”、“@”、“.”.
- The default user amount is 64 and the default group amount is 20. System account adopts two-level management: group and user. The user authorities shall be smaller than group authorities (The **admin** user authorities are set by default).
- For group or user management, there are two levels: admin and user. The user name shall be unique and one user shall only belong to one group.

5.10.5.7.1 User name

From main menu->Setup->System->Account->Account, enter account interface. See Figure 5-128.

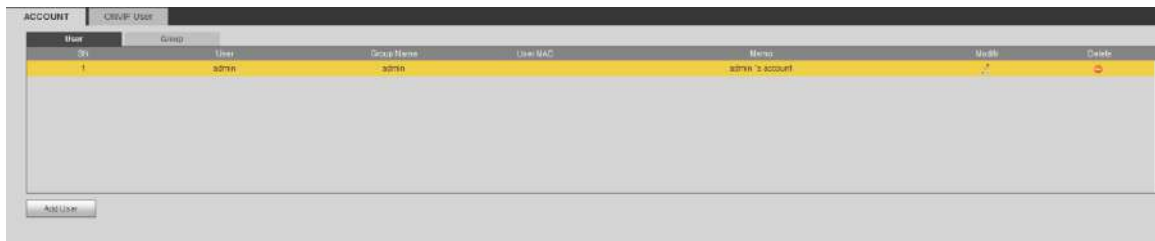

Figure 5-128

Add user

It is to add a name to group and set the user rights.

Step 1 Click Add user button.

Enter add user interface. See Figure 5-129.

Step 2 Here you can input the user name and password and then select one group for current user.

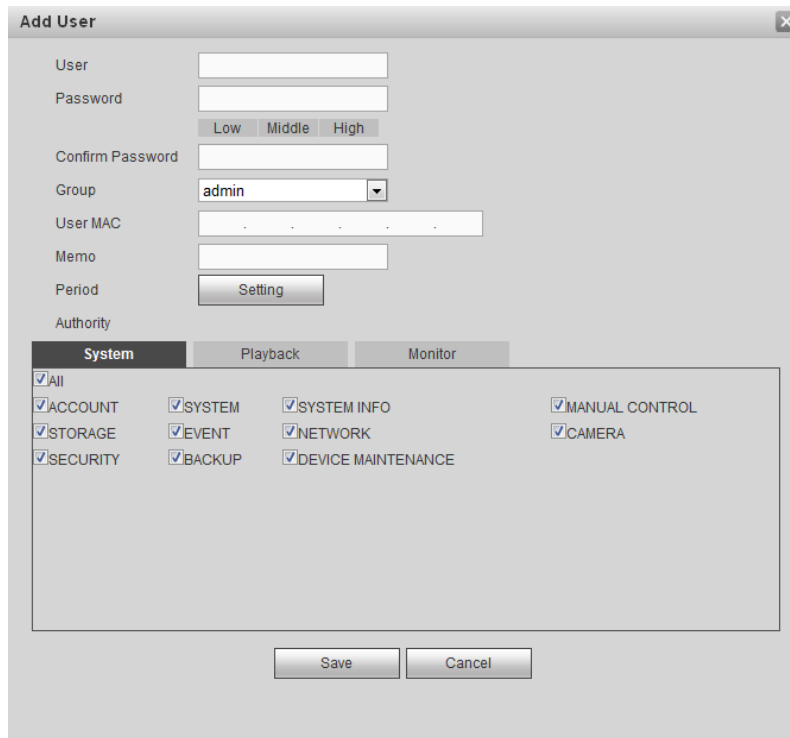

Figure 5-129

Step 3 Click the Set button after the period. It is to set valid period to use current account. See Figure 5-130.

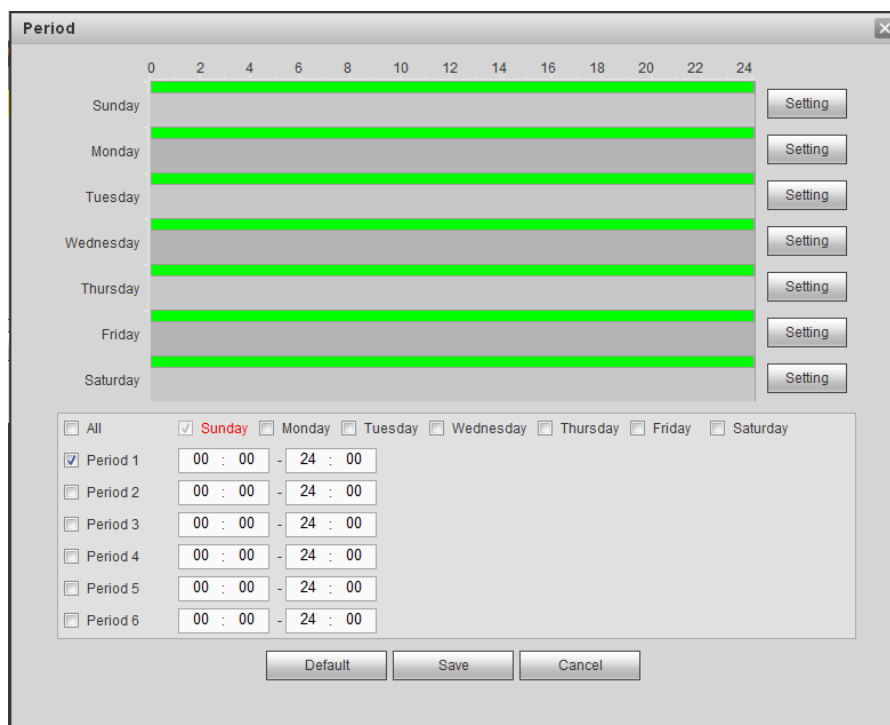

Figure 5-130

- Click Setting to set the periods. Or you can draw on the interface directly. There are six periods in one day. Or you can input start time and end time directly.
- Check the box before the date, the settings are for the selected date(s).
- Check the box before the period1-6, it is to enable the period function.

Step 4 Click Save to complete the setup.

 **Note**

Please note the user rights shall not exceed the group right setup. For convenient setup, please make sure the general user has the lower rights setup than the admin.

Modify user

It is to modify the user property, belonging group, password and rights. See Figure 5-131.

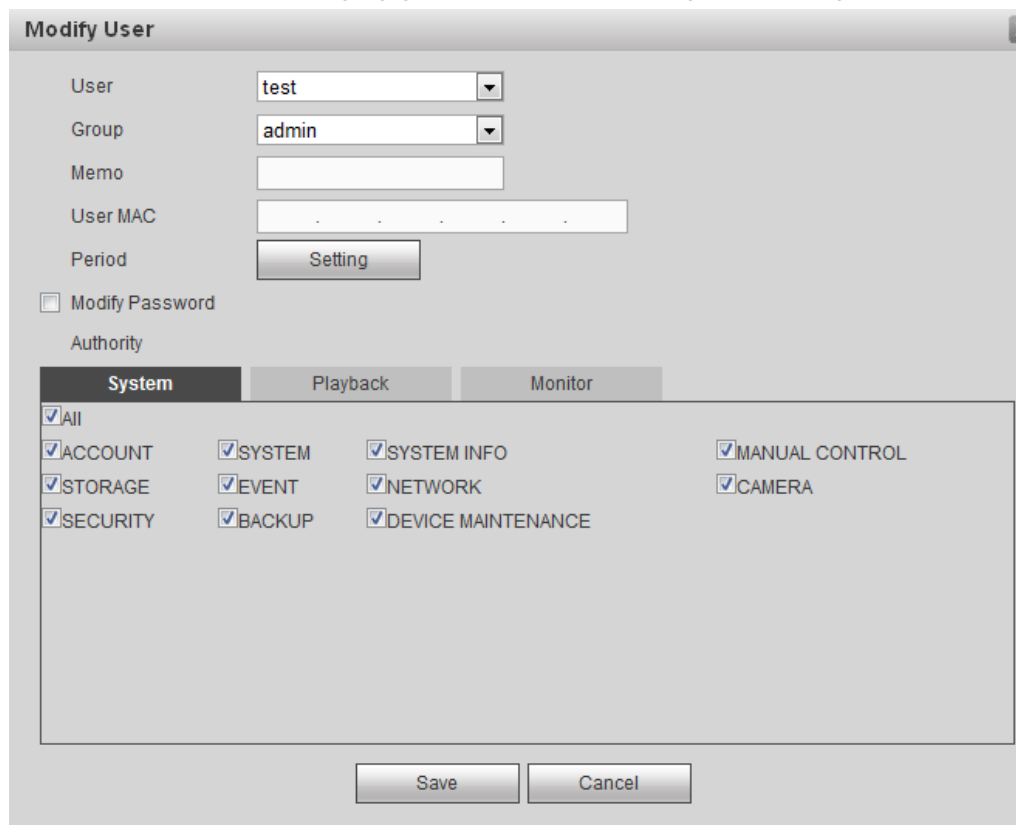

Modify User

User: test

Group: admin

Memo:

User MAC:

Period: Setting

Modify Password

Authority

System	Playback	Monitor
<input checked="" type="checkbox"/> All		
<input checked="" type="checkbox"/> ACCOUNT	<input checked="" type="checkbox"/> SYSTEM	<input checked="" type="checkbox"/> SYSTEM INFO
<input checked="" type="checkbox"/> STORAGE	<input checked="" type="checkbox"/> EVENT	<input checked="" type="checkbox"/> NETWORK
<input checked="" type="checkbox"/> SECURITY	<input checked="" type="checkbox"/> BACKUP	<input checked="" type="checkbox"/> DEVICE MAINTENANCE
		<input checked="" type="checkbox"/> MANUAL CONTROL
		<input checked="" type="checkbox"/> CAMERA

Save Cancel

Figure 5-131

 **Note**

For admin, you can change the email information. See Figure 5-132.

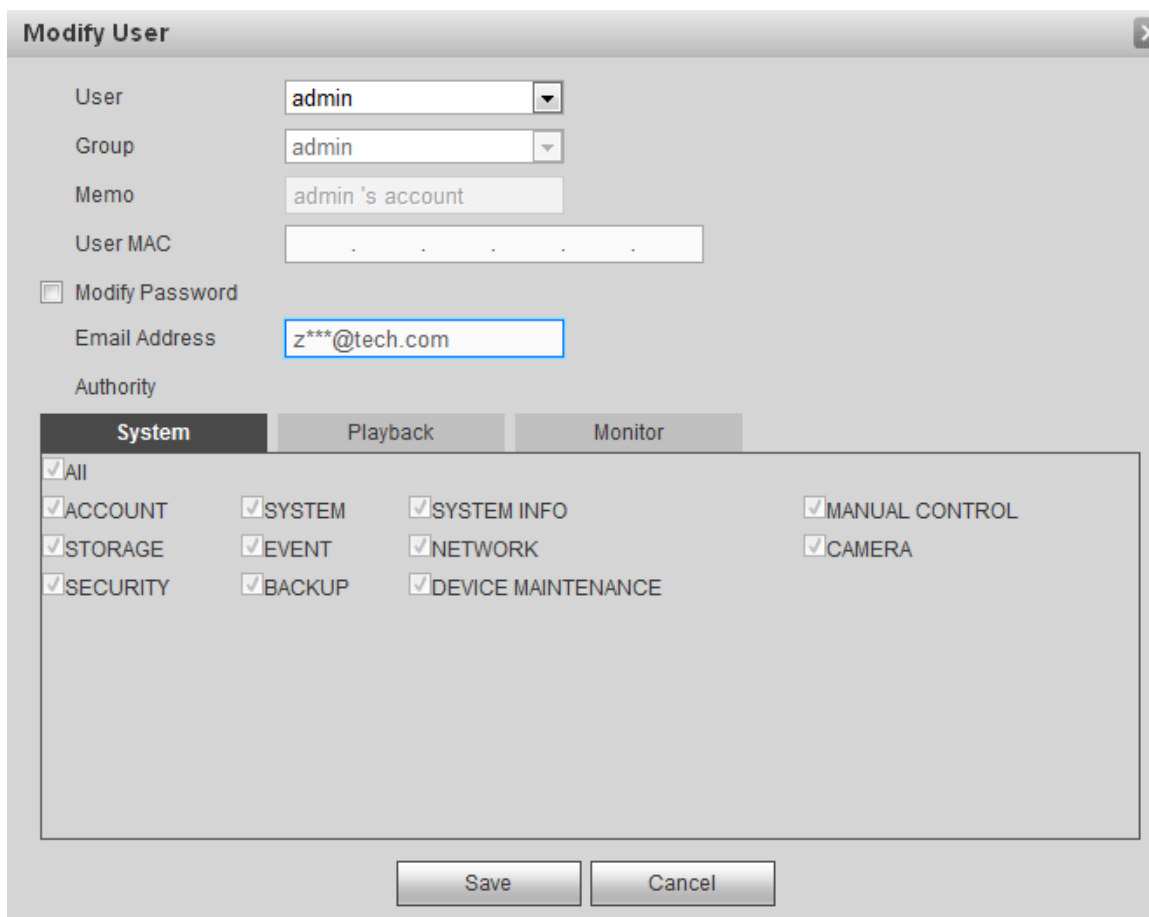

Figure 5-132

Modify password

It is to modify the user password.

Step 1 In Modify user interface, click Modify password box. See Figure 5-133.

Figure 5-133

- Step 2 Input old password, and then input new password and confirm.
- Step 3 Click Save button.



Note

The password ranges from 8 to 32 digitals. It can contain letters, numbers and special characters (excluding “'”, “””, “;”, “:”, “&”). The password shall contain at least two categories. Usually we recommend the strong password.



WARNING

STRONG PASSWORD RECOMMENDED-For your device own safety, please create a strong password of your own choosing. We also recommend you change your password periodically especially in the high security system.

5.10.5.7.2 Group

It is to add/remove group, modify group password and etc.
 From main menu->Setup->System->Account->Account.
 Click Group tab, the interface is shown as in Figure 5-134.

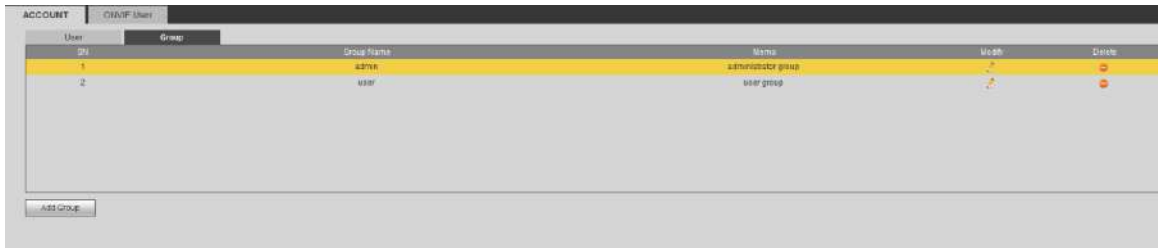

Figure 5-134

Add group

It is to add group and set its corresponding rights.

Step 1 Click Add group button. Enter add group interface. See Figure 5-135.

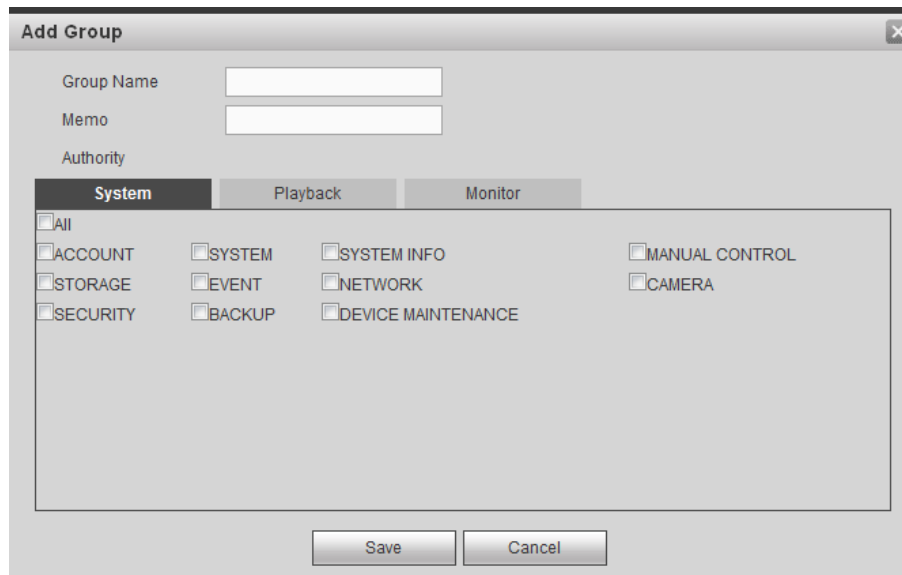



Figure 5-135

Step 2 Input the group name and then check the box to select the corresponding rights. It includes: system, playback, and monitor.

Step 3 Click Save button.

Modify group

Step 1 Select a group and then click . See Figure 5-136.

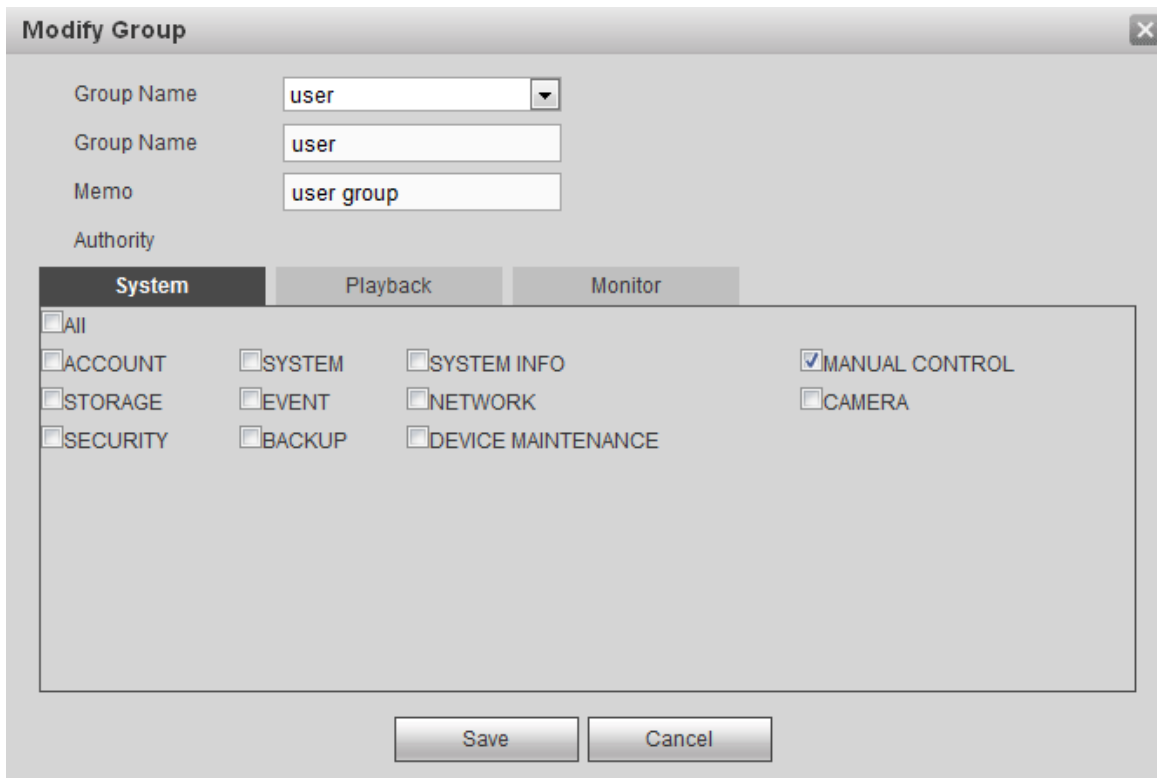

Figure 5-136

Step 2 Change corresponding information and then click Save button.

5.10.5.7.3 ONVIF User

When the camera from the third party is connected with the DVR via the ONVIF user, please use the verified ONVIF account to connect to the DVR.

Step 1 From main menu->Setting->System->Account->ONVIF User.
Enter ONVIF user interface. See Figure 2-59.

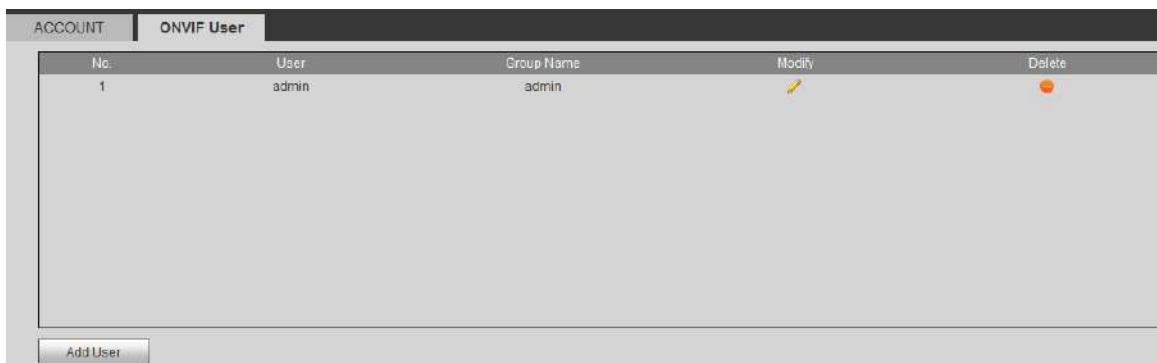

Figure 5-137



Step 2 Click Add user button.
Enter add user interface. See Figure 5-138.

Figure 5-138

Step 3 Set user name, password and then select group from the dropdown list.

Step 4 Click Save to complete setup.

 **Note**

Click  to change user information, click  to delete current user.

5.10.5.8 Security

To enhance device network security and protect device data, please set the access right of the IP host (IP host here refers to the IP PC or the server). After you enabled trusted sites function, only the IP listed below can access current DVR.

If you enable blocked sites function, the following listed IP addresses cannot access current DVR.

Step 1 From main menu->Setting->System->Security.

Enter security interface. See Figure 5-139.

Step 2 Check the Enable box.

Select trusted sites/block sites.

- Enable trusted site function and then add the whitelist.
- Enable blocked site function and then add the blacklist.

Step 3 Set parameters.

- Start address/end address: Select one type from the dropdown list, you can input IP address in the start address and end address. Now you can click Add IP address or Add IP section to add. System supports max 64 IP addresses.
 - a) For the newly added IP address, it is in enable status by default. Remove the \surd before the item, and then current item is not in the list.
 - b) System max supports 64 items.
 - c) Address column supports IPv4 or IPv6 format. If it is IPv6 address, system can optimize it. For example, system can optimize aa:0000: 00: 00aa: 00aa: 00aa: 00aa as aa:: aa: aa: aa: aa: aa: aa.
 - d) System automatically removes space if there is any space before or after the newly added IP address.
 - e) System only checks start address if you add IP address. System check start address and end address if you add IP section and the end address shall be larger than the start address.

- f) System may check newly added IP address exists or not. System does not add if input IP address does not exist.
 - Delete: Click it to remove specified item.
 - Edit: Click it to edit start address and end address. See Figure 5-140. System can check the IP address validity after the edit operation and implement IPv6 optimization.
 - Default: Click it to restore default setup. In this case, the trusted sites and blocked sites are both null.
- Step 4 Click Save to complete setup.
- If you enabled trusted sites, only the IP in the trusted sites list can access the device.
 - If you enabled blocked sites, the IP in the blocked sites cannot access the device.



Figure 5-139

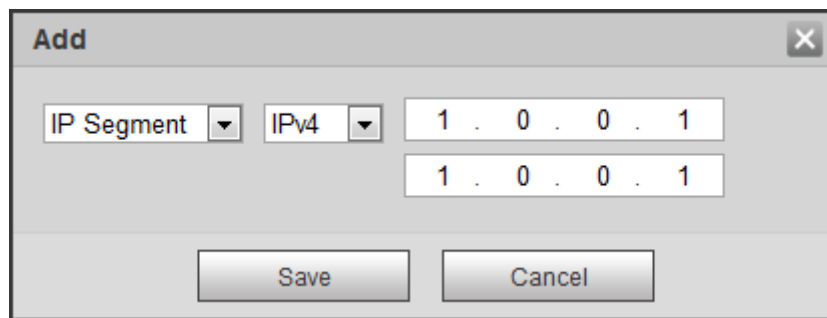

Figure 5-140

5.10.5.9 Auto maintain

The auto maintain interface is shown as in Figure 5-141.

Here you can select auto reboot and auto delete old files interval from the dropdown list.

If you want to use the auto delete old files function, you need to set the file period.

Click Manual reboot button, you can restart device manually.

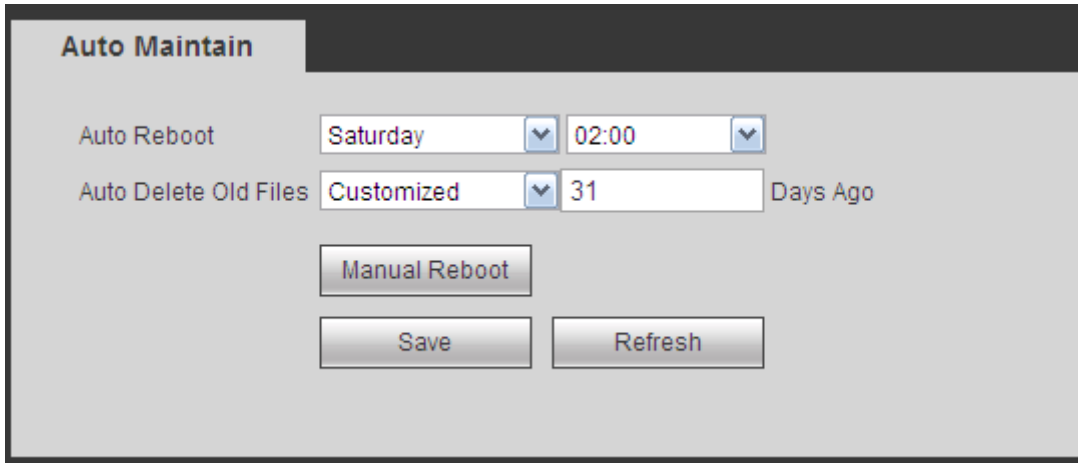

Figure 5-141

5.10.5.10 Import/Export

The interface is shown as in Figure 5-142. This interface is for you to export or import the configuration files.

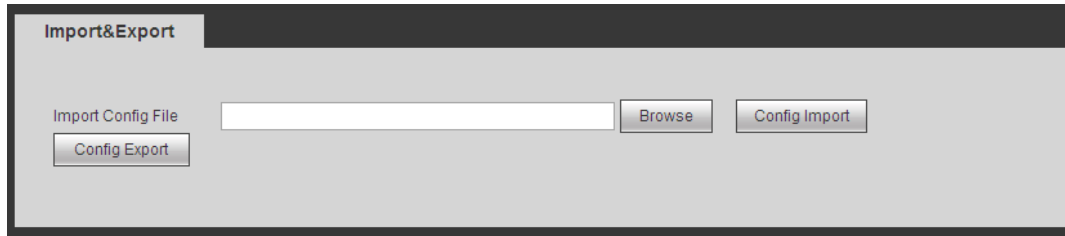

Figure 5-142

Please refer to the following sheet for detailed information.

Parameter	Function
Browse	Click to select import file.
Import	It is to import the local setup files to the system.
Export	It is to export the corresponding WEB setup to your local PC.

5.10.5.11 Default

The default setup interface is shown as in Figure 5-143.

Here you can select Network/Event/Storage/Setting/Camera. Or you can check the All box to select all items.

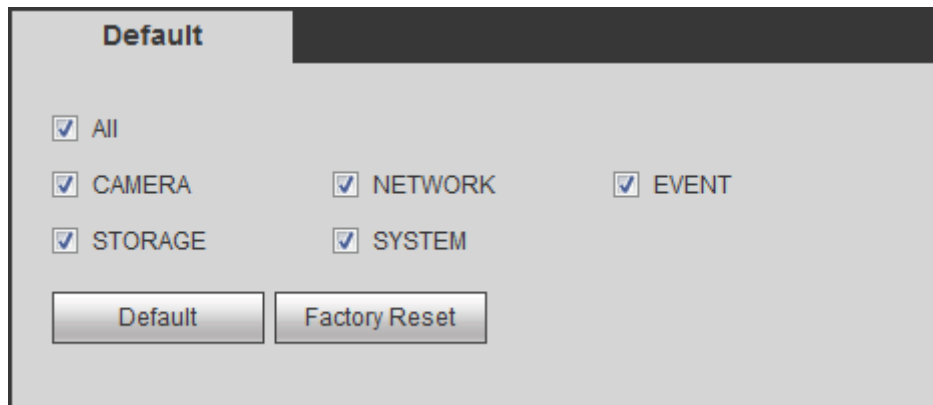

Figure 5-143

5.10.5.12 Upgrade



CAUTION

- During the upgrade process, do not unplug the power cable, network cable, or shutdown the device.
- Improper upgrade program may result in device malfunction!

There are two upgrade modes: file upgrade and online upgrade.

5.10.5.12.1.1 File Upgrade

The upgrade interface is shown as in Figure 5-144.

Please select the upgrade file and then click the update button to begin update. Please note the file name shall be as *.bin.

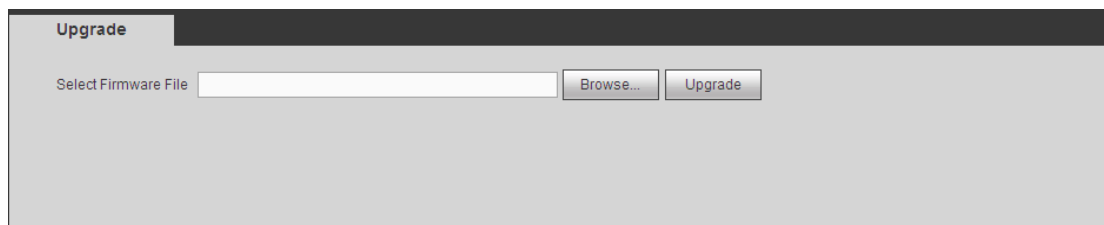

Figure 5-144

5.10.5.12.1.2 Online Upgrade

When the DVR is online, you can use the online upgrade to update the firmware.



Note

Make sure the DVR has properly connected to the network.

Version Detection

The version detection includes auto detection and manual detection. It displays current system version and application released date.

- Enable auto detection, DVR interactive with the cloud to detect there is new version available or not.
- Click manual detection, it is to view the latest new version on the cloud.
- If current version is the latest one, there is prompt "It is the latest version".
- If DVR detects there is new version available, system displays new version information such as released date and corresponding release note.

Upgrade System

Click Start to upgrade system.

5.11 Information

5.11.1 Version

The version interface is shown as in Figure 5-145. Please note the following information for reference only.

Here you can view record channel, alarm input/output information, software version, release date and etc. When there is any new version, it prompts found new version. Click it, NVR goes to upgrade interface.

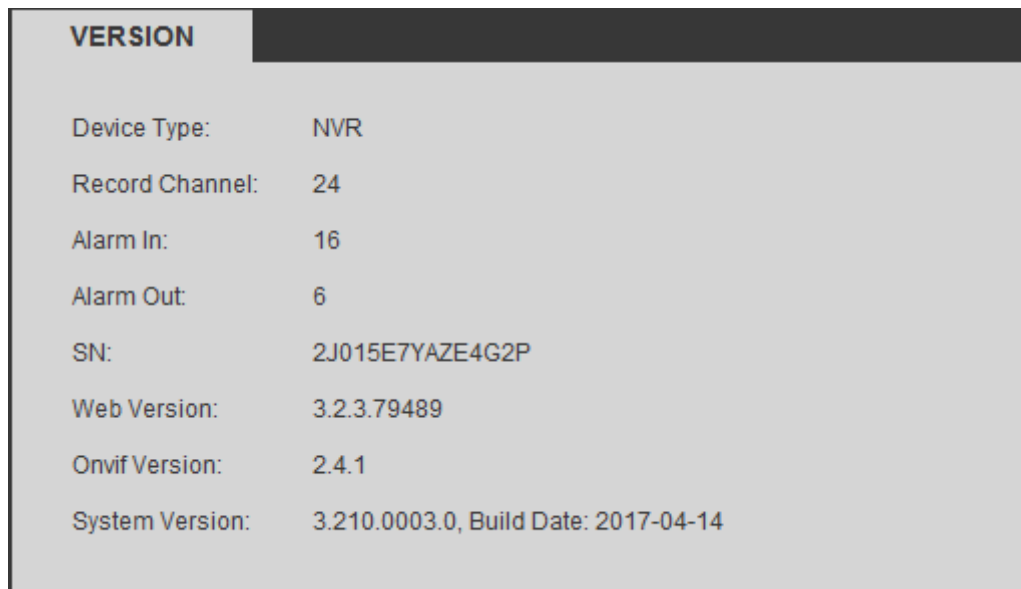

Device Type:	NVR
Record Channel:	24
Alarm In:	16
Alarm Out:	6
SN:	2J015E7YAZE4G2P
Web Version:	3.2.3.79489
Onvif Version:	2.4.1
System Version:	3.210.0003.0, Build Date: 2017-04-14

Figure 5-145

5.11.2 Log

Here you can view system log. See Figure 5-146.

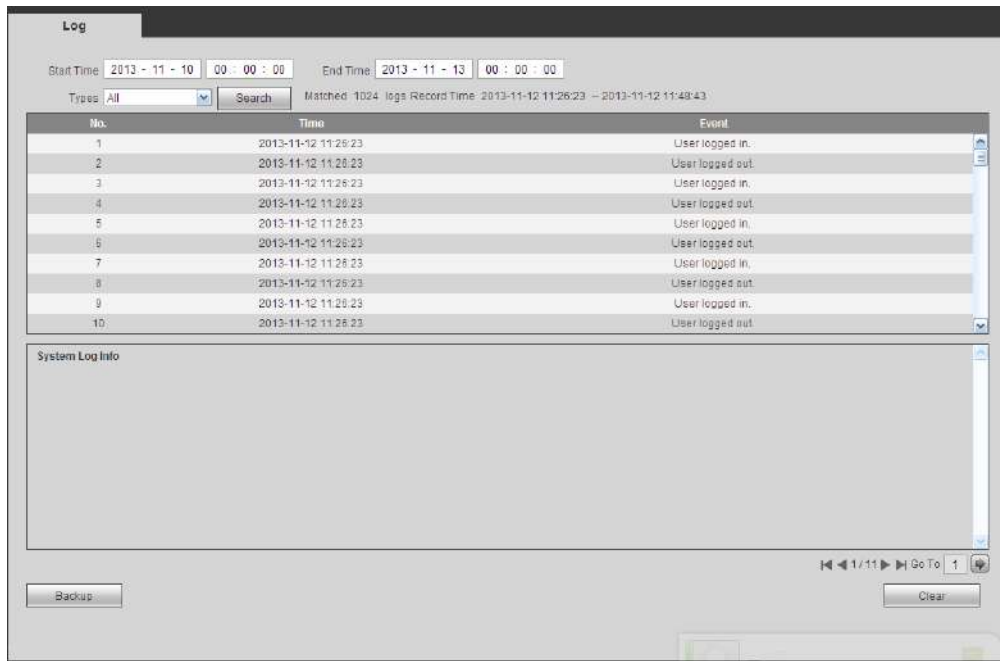

Figure 5-146

Please refer to the following sheet for log parameter information.

Parameter	Function
Type	Log types include: system operation, configuration operation, data operation, event operation, record operation, user management, log clear.
Start time	Set the start time of the requested log.
End time	Set the end time of the requested log.
Search	You can select log type from the drop down list and then click search button to view the list. You can click the stop button to terminate current search operation.
Detailed information	You can select one item to view the detailed information.
Clear	You can click this button to delete all displayed log files. Please note system does not support clear by type.
Backup	You can click this button to backup log files to current PC.

5.11.3 Online User

The online user interface is shown as in Figure 5-147.

No.	User Name	Group Name	IP Address	User Login Time
1	admin	admin	10.15.9.152	2013-10-24 04:31:33 PM
2	admin	admin	10.15.9.152	2013-10-24 04:21:12 PM
3	admin	admin	10.15.6.145	2013-10-24 04:50:01 PM

Refresh

Figure 5-147

5.11.4 People Counting

From main menu->Info->People counting, the interface is shown as in Figure 5-148.

PEOPLE COUNTING

Channel: 1

Report Type: Daily Report *Daily report max has 24 hours: Histogram Polygon Graph

Start Time: 2016-03-29 00 : 00 : 00 End Time: 2016-03-29 15 : 00 : 00

Flow Direction: Enter Exit Display No.

Graph

Report

Figure 5-148

5.11.5 Heat Map

From main menu->Info->Heat Map, the interface is shown as in Figure 5-149.

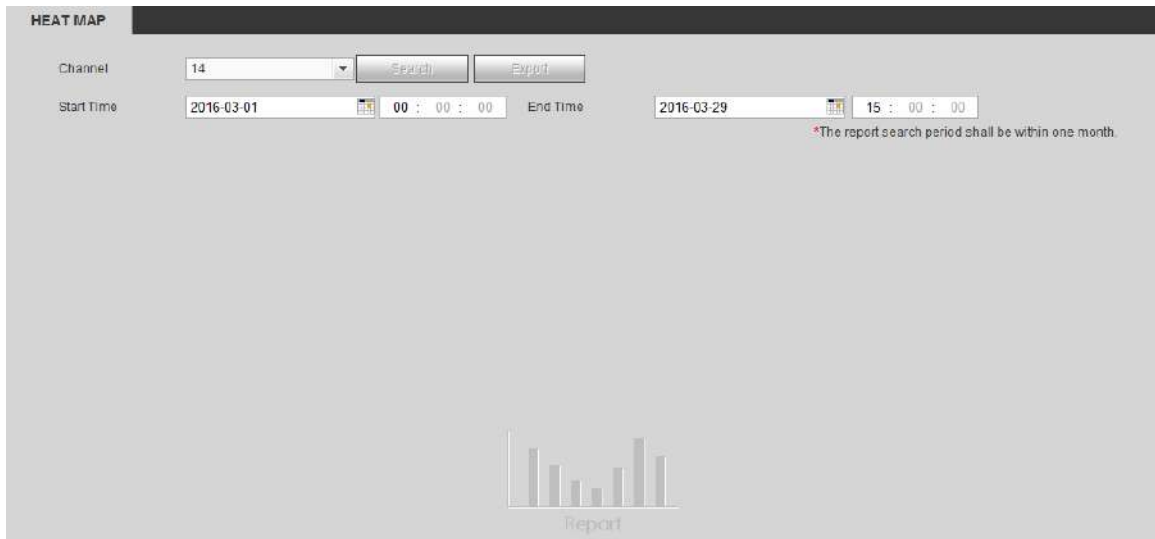

Figure 5-149

5.11.6 HDD

From main menu->Info->HDD, the HDD interface is shown as in Figure 5-150. Here you can view HDD information.

The screenshot shows the 'HDD' interface. It features a table with the following columns: Device Name, Physical Position, Status, Free Space/Total Space, S.M.A.R.T., and Path. Below the table are two buttons: 'HDD Time' and 'Refresh'.

Device Name	Physical Position	Status	Free Space/Total Space	S.M.A.R.T.	Path
sda	host_1	Normal	0GB/930.51GB		-

Figure 5-150

5.12 Playback

Click Playback button, you can see an interface is shown as in Figure 5-151.

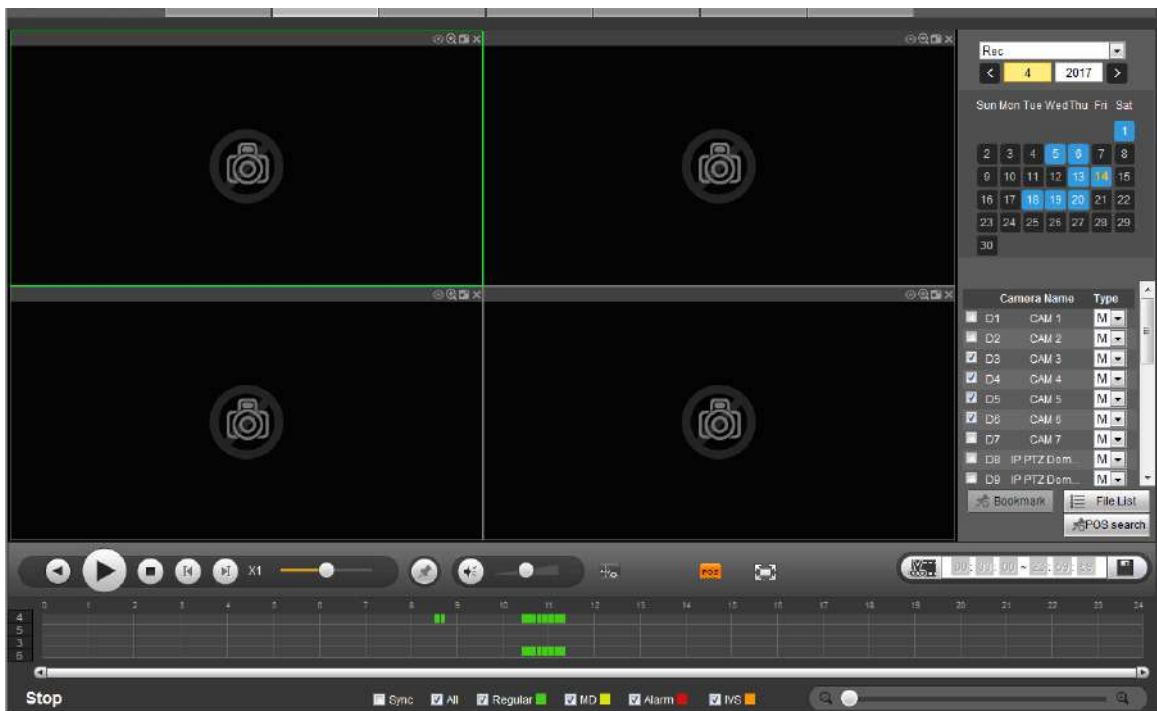

Figure 5-151

5.12.1 Search Record

Please set record type, record date, window display mode and channel name.

- Select Date

You can click the date on the right pane to select the date. The green highlighted date is system current date and the blue highlighted date means it has record files.

- Window Split

Select window split mode. Click  to display in full screen. Click ESC button to exit. See Figure 5-152.



Figure 5-152

- Select Channel

1~4 means main stream and A1~A4 means sub stream.

- Select Record Type

Check the corresponding box to select record type. See Figure 5-153.



Figure 5-153

5.12.2 File List

Click File list button, you can see the corresponding files in the list. See Figure 5-154.



Figure 5-154

5.12.3 Playback

Select a file you want to play and then click Play button, system can begin playback. You can select to playback in full-screen. Please note for one channel, system cannot playback and download at the same time. You can use the playback control bar to implement various operations such as play, pause, stop, slow play, fast play and etc. See Figure 5-155.



Figure 5-155

5.12.4 Download

Select the file(s) you want to download and then click download button, you can see an interface shown as in Figure 5-156. The Download button becomes Stop button and there is a process bar for your

reference. Please go to you default file saved path to view the files.



Figure 5-156

5.12.5 Load more

It is for you to search record or picture. You can select record channel, record type and record time to download. Or you can use watermark function to verify file.

5.12.5.1 Download By File

Select channel, record type, bit stream type and then input start time and end time. Click Search button, the download by file interface is shown as in Figure 5-157.

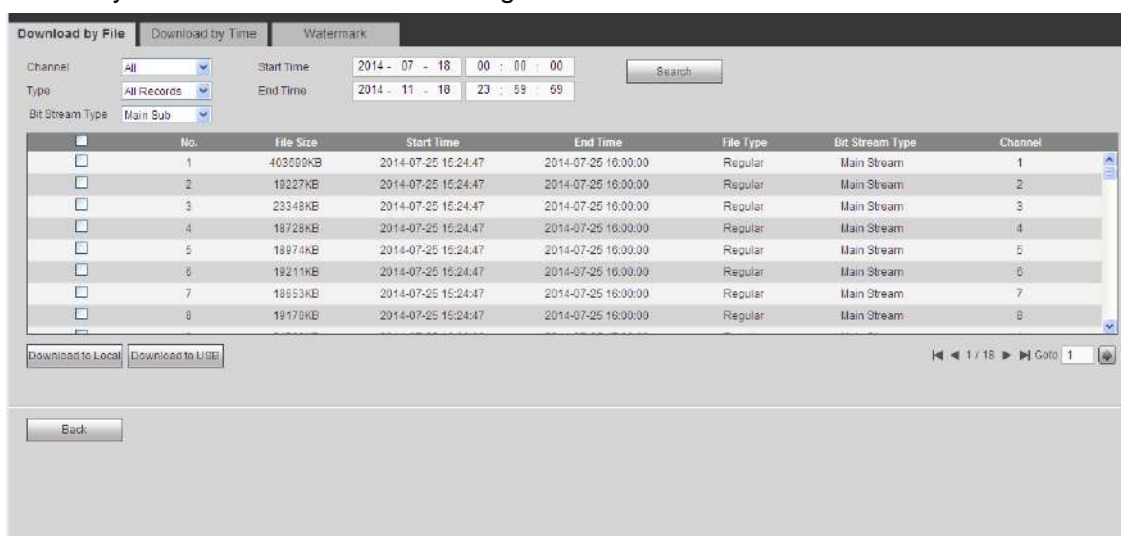

Figure 5-157

Check the file(s) you want to download and there are two options for you to save the file(s).

- Download to local

Click Download to local, system pops up the following interface for you to set record format and saved path. See Figure 5-158.



Figure 5-158

You can click OK to download and view the download process. After the download operation, you can see corresponding dialog box.

- Download to USB

Connect the corresponding peripheral device, and then click Download to USB button, you can see the following interface. See Figure 5-159.

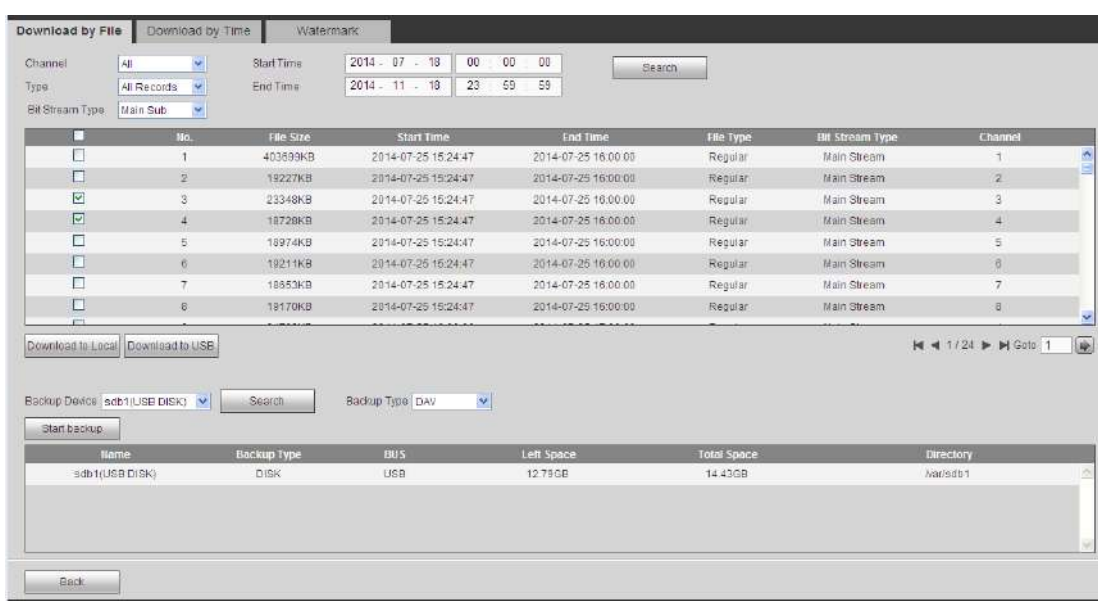

Figure 5-159

Select Backup device and backup type first and then click Start backup button.

After the download operation, you can see corresponding dialogue box.

5.12.5.2 Download by Time

Select channel, bit stream type, start time and end time.

Click Download to Local button, you can see download by time interface is shown as in Figure 5-160.

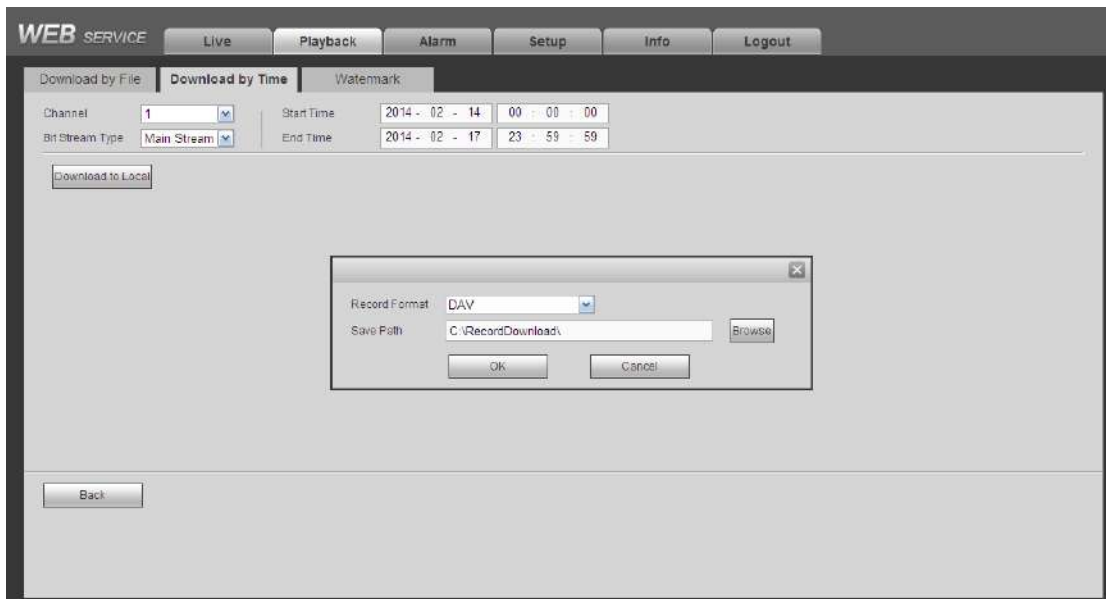

Figure 5-160

Set record format and saved path, you can click OK to download and view the download process. After the download operation, you can see corresponding dialog box.

5.12.5.3 Watermark

Watermark interface is shown as In Figure 5-161. Please select a file and then click Verify button to see the file has been tampered with or not

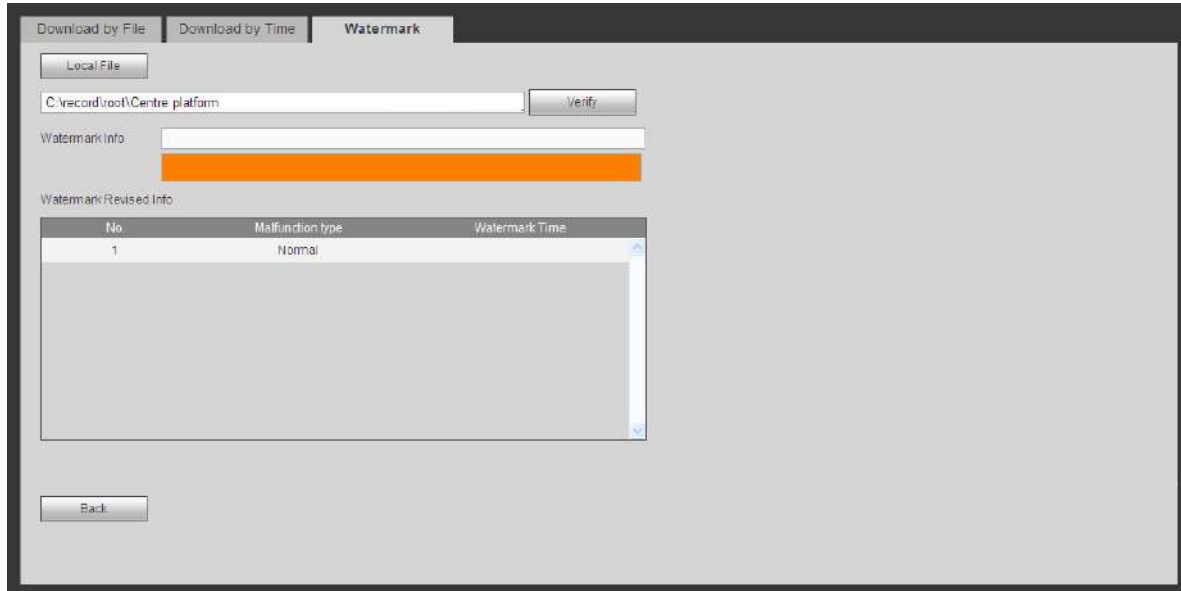

Figure 5-161

5.13 Smart Playback

It is to search and playback the IVS file, human face file and plate recognition record.

 **Note**

- There are two types to realize intelligent analytics function.
- ✧ Smart network camera supports intelligent functions: Some smart camera supports the intelligent functions. For NVR, it just displays the intelligent alarm information from the smart network camera and set or playback the record file.
- ✧ NVR supports intelligent functions: The connected network camera does not support intelligent video analytics function. The NVR supports the analytics function.
- This function is to playback the intelligent record file of the smart camera.

5.13.1 IVS (Behavior Analytics)

It is to search and playback the IVS record file.

Step 1 Click Smart Play.

Enter the smart play interface. See Figure 5-162.

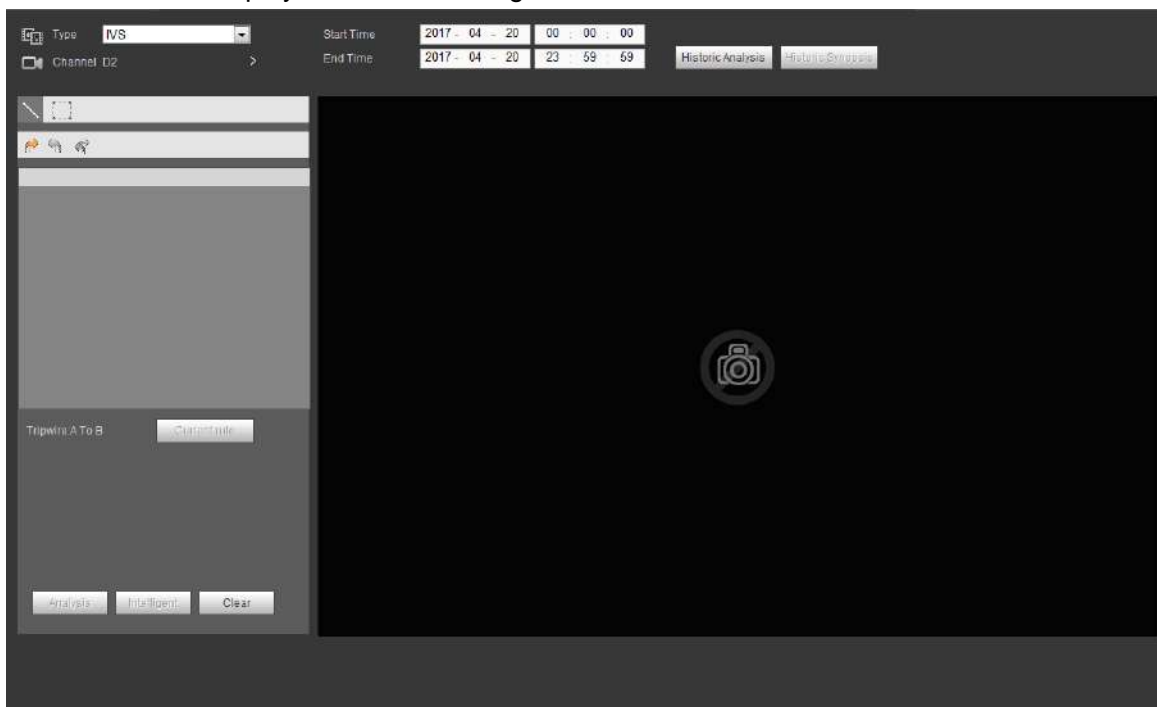

Figure 5-162

Step 2 Select detection type as IVS.

Step 3 Select a channel.

Enter the following interface. See Figure 5-163.

Note

The IVS function is for one-channel mode only.

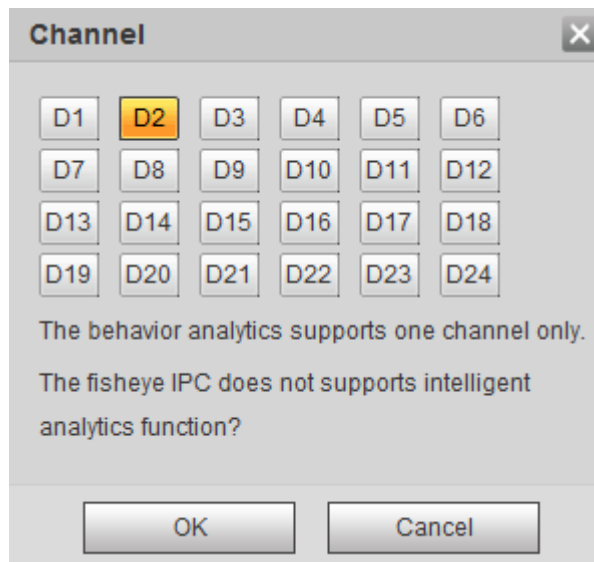





Figure 5-163

- Step 4 Select a channel number and then click OK.
- Step 5 Set detection type as IVS and then set start time and end time.
- Step 6 Click Historic Analytics.
Device displays the corresponding image.
- Step 7 Click the image; you can view the record file.

- Select a file and then click , you can save current file to peripheral storage device.
- Select a file and then click , you can lock current file in case it will be overwritten in the future
- Select a file and then click , you can mark the time of the detected event.

5.13.2 Plate recognition

It is to search and playback the record file containing the plate number.

- Step 1 From main menu->Operation->Smart Play.
Enter the smart play interface. See Figure 5-164.

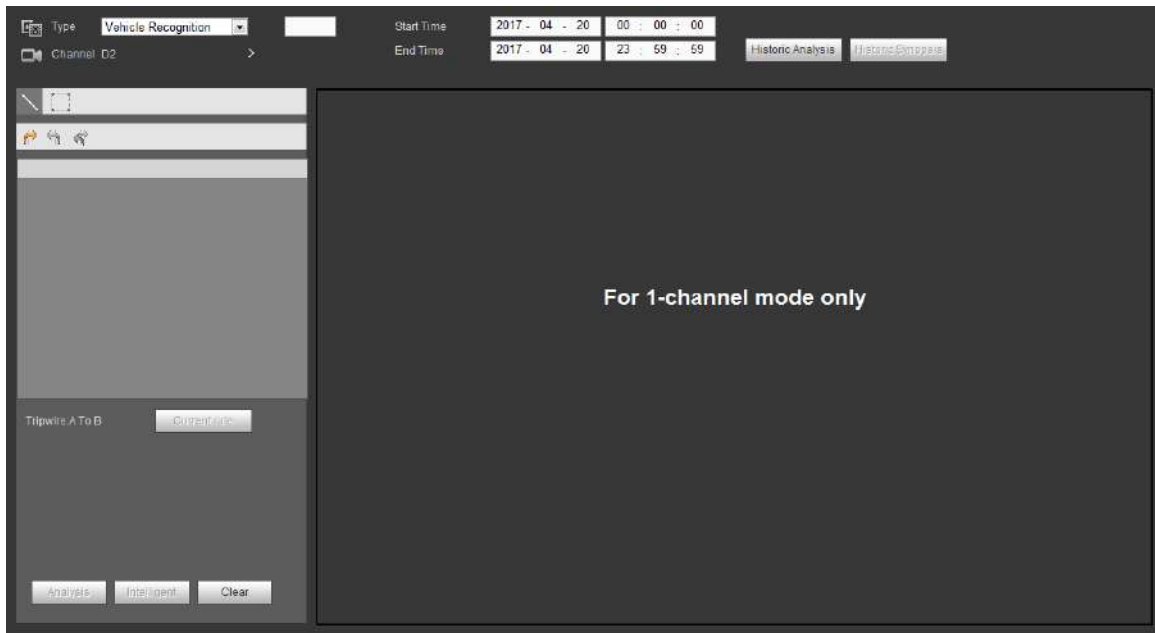

Figure 5-164

Step 2 Set plate number, channel number, start time, end time.

 **Note**

Device supports fuzzy plate number search function.



Device searches all plate numbers by default if you do not input plate number information.

The plate number search and playback function is for one-channel mode only.

Step 3 Click Historic Analytics.

Device displays the corresponding image.

Step 4 Click the image; you can view the record file.

- Select a file and then click , you can save current file to peripheral storage device.
- Select a file and then click , you can lock current file in case it will be overwritten in the future
- Select a file and then click , you can mark the time of the detected event.

5.13.3 Human Face

System can search the record containing the human face and then playback.

Important



Before you use this function, please make sure current channel has enabled human face detection function. Please refer to chapter 5.10.3.3 (Setup->Event->Face Detection) for detailed information.

Set the search type as face detect, set channel, start time and end time.

Click Historic analysis button at the right pane or Analysis button at the bottom of the interface, system begins to search. You can view the event time and image. See Figure 5-165.

Click the image, system begins playback.

- Select the file and then click  Tag, you can save current file to peripheral device.

- Select the file and then click  **Locked**, you can lock the file in case it will be overwritten in the future.
- Select the file and then click  **Backup**, you can mark the time of the detected event.

 **Note**

The following human face has been modified for privacy reason. The actual snapshot image has high definition.

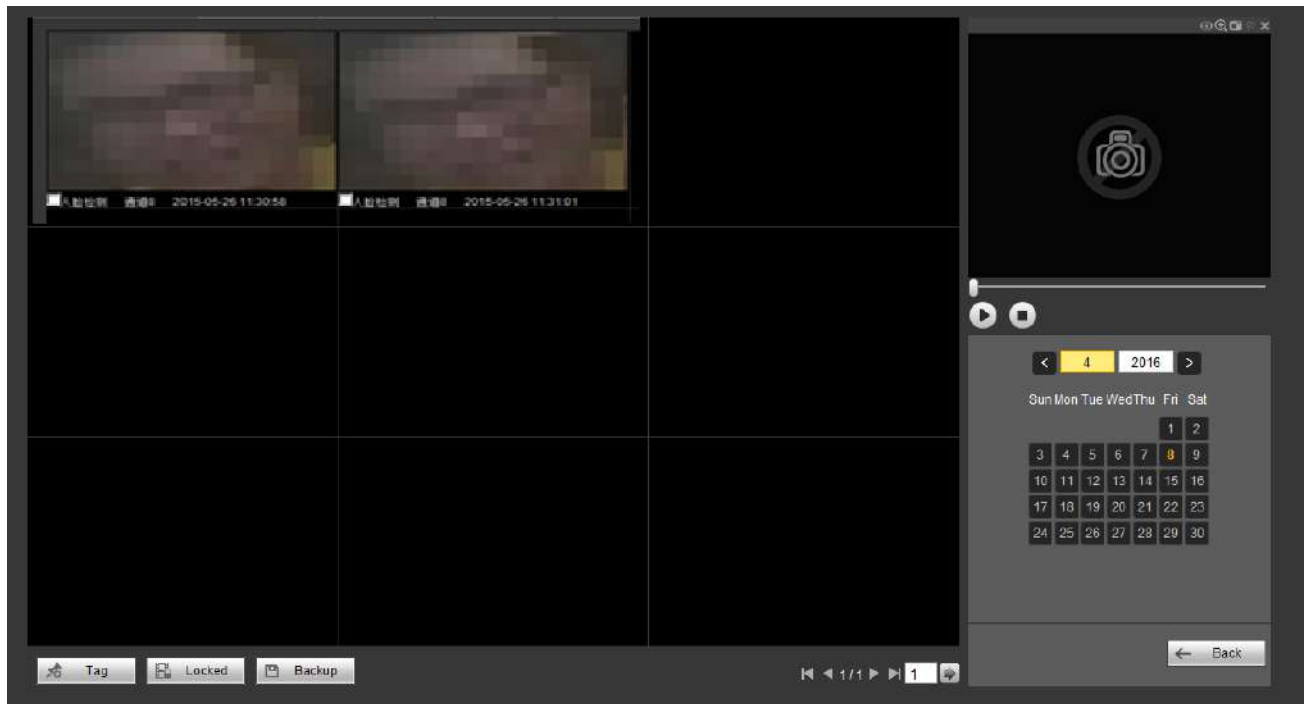

Figure 5-165

5.14 Alarm

Click alarm function, you can see an interface is shown as Figure 5-166.

Here you can set device alarm type and alarm sound setup (Please make sure you have enabled audio function of corresponding alarm events.).

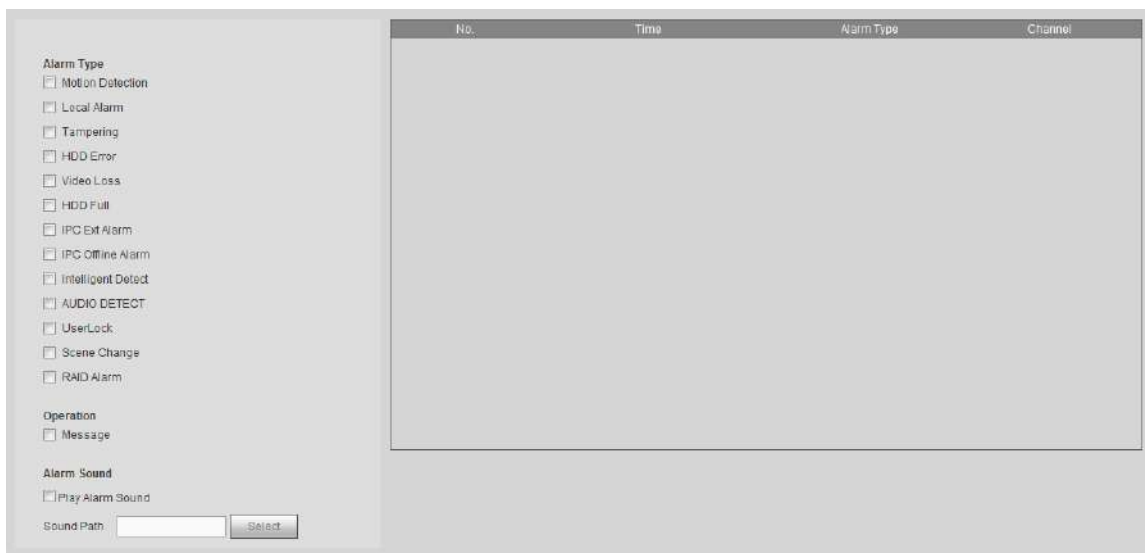

Figure 5-166

Please refer to the following sheet for detailed information.

Type	Parameter	Function
Alarm Type	Video loss	System alarms when video loss occurs.
	Motion detection	System alarms when motion detection alarm occurs.
	Tampering	System alarms when camera is viciously masking.
	Disk full	System alarms when disk is full.
	Disk error	System alarms when disk error occurs.
	External alarm	Alarm input device sends out alarm.
	IPC external alarm	It refers to the on-off signal from the network camera. It can activate the NVR local activation operation.
	IPC offline alarm	System can generate an alarm when the network camera and the NVR are disconnected.
	Intelligent detect	System alarms when IVS alarm occurs.
	Audio detect	System alarms when audio detect is abnormal.
Operation	Prompt	Check the box here, system can automatically pops up an alarm icon on the Alarm button in the main interface when there is an alarm.
Alarm Sound	Play alarm sound	System sends out alarm sound when an alarm occurs. You can specify as you wish.
	Sound path	Here you can specify alarm sound file.

5.15 Log out

Click log out button, system goes back to log in interface. See Figure 5-167.

You need to input user name and password to login again.



Figure 5-167

5.16 Un-install Web Control

You can use web un-install tool “uninstall web.bat” to un-install web control.

Please note, before you un-installation, please close all web pages, otherwise the un-installation might result in error

6 Glossary

- **DHCP:** DHCP (Dynamic Host Configuration Protocol) is a network protocol. It is one of the TCP/IP protocol cluster. It is principally used to assign temporary IP addresses to computers on a network.
- **DDNS:** DDNS (Dynamic Domain Name Server) is a service that maps Internet domain names to IP addresses. This service is useful to anyone who wants to operate a server (web server, mail server, ftp server and etc) connected to the internet with a dynamic IP or to someone who wants to connect to an office computer or server from a remote location with software.
- **eSATA:** eSATA(External Serial AT) is an interface that provides fast data transfer for external storage devices. It is the extension specifications of a SATA interface.
- **GPS:** GPS (Global Positioning System) is a satellite system, protected by the US military, safely orbiting thousands of kilometers above the earth.
- **PPPoE: PPPoE** (Point to Point Protocol over Ethernet) is a specification for connecting multiple computer users on an Ethernet local area network to a remote site. Now the popular mode is ADSL and it adopts PPPoE protocol.
- **WIFI:** Wi-Fi is the name of a popular wireless networking technology that uses radio waves to provide wireless high-speed Internet and network connections. The standard is for wireless local area networks (WLANs). It is like a common language that all the devices use to communicate to each other. It is actually IEEE802.11, a family of standard The IEEE (Institute of Electrical and Electronics Engineers Inc.)
- **3G:** 3G is the wireless network standard. It is called 3G because it is the third generation of cellular telecom standards. 3G is a faster network for phone and data transmission and speed is over several hundred kbps. Now there are four standards: CDMA2000, WCDMA, TD-SCDMA and WiMAX.
- **Dual-stream:** The dual-stream technology adopts high-rate bit stream for local HD storage such as QCIF/CIF/2CIF/DCIF/4CIF encode and one low-rate bit stream for network transmission such as QCIF/CIF encode. It can balance the local storage and remote network transmission. The dual-stream can meet the difference band width requirements of the local transmission and the remote transmission. In this way, the local transmission using high-bit stream can achieve HD storage and the network transmission adopting low bit stream suitable for the fluency requirements of the 3G network such as WCDMA, EVDO, TD-SCDMA..
- **On-off value:** It is the non-consecutive signal sampling and output. It includes remote sampling and remote output. It has two statuses: 1/0.

7 FAQ

Questions	Solutions
<p>NVR cannot boot up properly.</p>	<ul style="list-style-type: none"> ● Input power is not correct. ● Power connection is not correct. ● Power switch button is damaged. ● Program upgrade is wrong. ● HDD malfunction or something wrong with HDD ribbon. ● Seagate DB35.1, DB35.2, SV35 or Maxtor 17-g has compatibility problem. Please upgrade to the latest version to solve this problem. ● Front panel error. ● Main board is damaged.
<p>NVR often automatically shuts down or stops running.</p>	<ul style="list-style-type: none"> ● Input voltage is not stable or it is too low. ● HDD malfunction or something wrong with the ribbon. ● Button power is not enough. ● Front video signal is not stable. ● Working environment is too harsh, too much dust. ● Hardware malfunction.
<p>System cannot detect hard disk.</p>	<ul style="list-style-type: none"> ● HDD is broken. ● HDD ribbon is damaged. ● HDD cable connection is loose. ● Main board SATA port is broken.
<p>There is no video output whether it is one-channel, multiple-channel or all-channel output.</p>	<ul style="list-style-type: none"> ● Program is not compatible. Please upgrade to the latest version. ● Brightness is 0. Please restore factory default setup. ● Check your screen saver. ● NVR hardware malfunctions.
<p>I cannot search local records.</p>	<ul style="list-style-type: none"> ● HDD ribbon is damaged. ● HDD is broken. ● Upgraded program is not compatible. ● The recorded file has been overwritten. ● Record function has been disabled.
<p>Video is distorted when searching local records.</p>	<ul style="list-style-type: none"> ● Video quality setup is too low. ● Program read error, bit data is too small. There is mosaic in the full screen. Please restart the NVR to solve this problem. ● HDD data ribbon error. ● HDD malfunction. ● NVR hardware malfunctions.
<p>Time display is not correct.</p>	<ul style="list-style-type: none"> ● Setup is not correct ● Battery contact is not correct or voltage is too low. ● Crystal is broken.

Questions	Solutions
NVR cannot control PTZ.	<ul style="list-style-type: none"> ● Front panel PTZ error ● PTZ decoder setup, connection or installation is not correct. ● Cable connection is not correct. ● PTZ setup is not correct. ● PTZ decoder and NVR protocol is not compatible. ● PTZ decoder and NVR address is not compatible. ● When there are several decoders, please add 120 Ohm between the PTZ decoder A/B cables furthest end to delete the reverberation or impedance matching. Otherwise the PTZ control is not stable. ● The distance is too far.
I cannot log in client-end or web.	<ul style="list-style-type: none"> ● For Windows 98 or Windows ME user, please update your system to Windows 2000 sp4. Or you can install client-end software of lower version. Please note right now, our NVR is not compatible with Windows VISTA control. ● ActiveX control has been disabled. ● No dx8.1 or higher. Please upgrade display card driver. ● Network connection error. ● Network setup error. ● Password or user name is invalid. ● Client-end is not compatible with NVR program.
There is only mosaic no video when preview or playback video file remotely.	<ul style="list-style-type: none"> ● Network fluency is not good. ● Client-end resources are limit. ● Current user has no right to monitor.
Network connection is not stable.	<ul style="list-style-type: none"> ● Network is not stable. ● IP address conflict. ● MAC address conflict. ● PC or device network card is not good.
Burn error /USB back error.	<ul style="list-style-type: none"> ● Burner and NVR are in the same data cable. ● System uses too much CPU resources. Please stop record first and then begin backup. ● Data amount exceeds backup device capacity. It may result in burner error. ● Backup device is not compatible. ● Backup device is damaged.
Keyboard cannot control NVR.	<ul style="list-style-type: none"> ● NVR serial port setup is not correct ● Address is not correct ● When there are several switchers, power supply is not enough. ● Transmission distance is too far.

Questions	Solutions
Alarm signal cannot be disarmed.	<ul style="list-style-type: none"> ● Alarm setup is not correct. ● Alarm output has been open manually. ● Input device error or connection is not correct. ● Some program versions may have this problem. Please upgrade your system.
Alarm function is null.	<ul style="list-style-type: none"> ● Alarm setup is not correct. ● Alarm cable connection is not correct. ● Alarm input signal is not correct. ● There are two loops connect to one alarm device.
Record storage period is not enough.	<ul style="list-style-type: none"> ● Camera quality is too low. Lens is dirty. Camera is installed against the light. Camera aperture setup is not correct. ● HDD capacity is not enough. ● HDD is damaged.
Cannot playback the downloaded file.	<ul style="list-style-type: none"> ● There is no media player. ● No DXB8.1 or higher graphic acceleration software. ● There is no DivX503Bundle.exe control when you play the file transformed to AVI via media player. ● No DivX503Bundle.exe or ffdshow-2004 1012 .exe in Windows XP OS.
Forgot local menu operation password or network password	<ul style="list-style-type: none"> ● Please contact your local service engineer or our sales person for help. We can guide you to solve this problem.
There is no video. The screen is in black.	<ul style="list-style-type: none"> ● IPC IP address is not right. ● IPC port number is not right. ● IPC account (user name/password) is not right. ● IPC is offline.
The displayed video is not full in the monitor.	Please check current resolution setup. If the current setup is 1920*1080, then you need to set the monitor resolution as 1920*1080.
There is no HDMI output.	<ul style="list-style-type: none"> ● Displayer is not in HDMI mode. ● HDMI cable connection is not right.
The video is not fluent when I view in multiple-channel mode from the client-end.	<ul style="list-style-type: none"> ● The network bandwidth is not sufficient. The multiple-channel monitor operation needs at least 100M or higher. ● Your PC resources are not sufficient. For 16-ch remote monitor operation, the PC shall have the following environment: Quad Core, 2G or higher memory, independent displayer, display card memory 256M or higher.

Questions	Solutions
I can not connect to the IPC	<ul style="list-style-type: none"> ● Please make sure the IPC has booted up. ● IPC network connection is right and it is online ● IPC IP is in the blacklist. ● The device has connected to the too many IPC. It cannot transmit the video. ● Check the IPC port value and the time zone is the same as the NVR. ● Make sure current network environment is stable.
After I set the NVR resolution as 1080P, my monitor can not display.	Shut down the device and then reboot. When you reboot, please press the Fn button at the same time and then release after 5 seconds. You can restore NVR resolution to the default setup.
My admin account has been changed and I can not log in.	Use telnet and then input the following command: <pre>cd /mnt/mtd/Config/ rm -rf group rm -rf password</pre> Reboot the device to restore the default password.
After I login the Web , I can not find the remote interface to add the IPC.	Please clear the Web controls and load again.
There is IP and gateway, I can access the internet via the router. But I can not access the internet after I reboot the NVR.	Please use command PING to check you can connect to the gateway or not. Use telnet to access and then use command "ifconfig -a" to check device IP address. If you see the subnet mask and the gateway has changed after the reboot. Please upgrade the applications and set again.
I use the VGA montior.I want to know if I use the multiple-window mode, I see the video from the main stream or the sub stream?	<ul style="list-style-type: none"> ● For 32-channel series product, the 9/16-window is using the sub stream. ● For 4/8/16 series product, system is using the main stream no matter you are in what display mode.

Daily Maintenance

- Please use the brush to clean the board, socket connector and the chassis regularly.
- The device shall be soundly earthed in case there is audio/video disturbance. Keep the device away from the static voltage or induced voltage.
- Please unplug the power cable before you remove the audio/video signal cable, RS232 or RS485 cable.
- Do not connect the TV to the local video output port (VOUT).It may result in video output circuit.
- Always shut down the device properly. Please use the shutdown function in the menu, or you can press the power button in the rear pane for at least three seconds to shut down the device.

Otherwise it may result in HDD malfunction.

- Please make sure the device is away from the direct sunlight or other heating sources. Please keep the sound ventilation.
- Please check and maintain the device regularly.

8 Appendix A HDD Capacity Calculation

Calculate total capacity needed by each device according to video recording (video recording type and video file storage time).

Step 1: According to Formula (1) to calculate storage capacity q_i that is the capacity of each channel needed for each hour, unit Mbyte.

$$q_i = d_i \div 8 \times 3600 \div 1024 \quad (1)$$

In the formula: d_i means the bit rate, unit Kbit/s

Step 2: After video time requirement is confirmed, according to Formula (2) to calculate the storage capacity m_i , which is storage of each channel needed unit Mbyte.

$$m_i = q_i \times h_i \times D_i \quad (2)$$

In the formula:

h_i means the recording time for each day (hour)

D_i means number of days for which the video shall be kept

Step 3: According to Formula (3) to calculate total capacity (accumulation) q_T that is needed for all channels in the device during **scheduled video recording**.

$$q_T = \sum_{i=1}^c m_i \quad (3)$$

In the formula: c means total number of channels in one device

Step 4: According to Formula (4) to calculate total capacity (accumulation) q_T that is needed for all channels in device during **alarm video recording (including motion detection)**.

$$q_T = \sum_{i=1}^c m_i \times a\% \quad (4)$$

In the formula: $a\%$ means alarm occurrence rate

9 Appendix B Compatible Network Camera List

Please note all the models in the following list for reference only. For those products not included in the list, please contact your local retailer or technical supporting engineer for detailed information.

Manufacture	Model	Version	Video Encode	Audio/Video	Protocol
AXIS	P1346	5.40.9.2	H264	√	ONVIF/Private
	P3344/P3344-E	5.40.9.2	H264	√	ONVIF/Private
	P5512	—	H264	√	ONVIF/Private
	Q1604	5.40.3.2	H264	√	ONVIF/Private
	Q1604-E	5.40.9	H264	√	ONVIF/Private
	Q6034E	—	H264	√	ONVIF/Private
	Q6035	5.40.9	H264	√	ONVIF/Private
	Q1755	—	H264	√	ONVIF/Private
	M7001	—	H264	√	Private
	M3204	5.40.9.2	H264	√	Private
	P3367	HEAD LFP4_0 130220	H264	√	ONVIF
	P5532-P	HEAD LFP4_0 130220	H264	√	ONVIF
ACTi	ACM-3511	A1D-220-V3.12 .15-AC	MPEG4	√	Private
	ACM-8221	A1D-220-V3.13 .16-AC	MPEG4	√	Private
Arecont	AV1115	65246	H264	√	Private
	AV10005DN	65197	H264	√	Private
	AV2115DN	65246	H264	√	Private
	AV2515DN	65199	H264	√	Private
	AV2815	65197	H264	√	Private
	AV5115DN	65246	H264	√	Private
	AV8185DN	65197	H264	√	Private
Bosch	NBN-921-P	—	H264	√	ONVIF
	NBC-455-12P	—	H264	√	ONVIF
	VG5-825	9500453	H264	√	ONVIF
	NBN-832	66500500	H264	√	ONVIF
	VEZ-211-IWT EIVA	—	H264	√	ONVIF
	NBC-255-P	15500152	H264	√	ONVIF
	VIP-X1XF	—	H264	√	ONVIF
Brikcom	B0100	—	H264	√	ONVIF
	D100	—	H264	√	ONVIF
	GE-100-CB	—	H264	√	ONVIF
	FB-100A	v1.0.3.9	H264	√	ONVIF
	FD-100A	v1.0.3.3	H264	√	ONVIF

Manufacture	Model	Version	Video Encode	Audio/Video	Protocol
Cannon	VB-M400	—	H264	√	Private
CNB	MPix2.0DIR	XNETM112011 1229	H264	√	ONVIF
	VIPBL1.3MIR VF	XNETM210011 1229	H264	√	ONVIF
	IGC-2050F	XNETM210011 1229	H264	√	ONVIF
CP PLUS	CP-NC9-K	6.E.2.7776	H264	√	ONVIF/Private
	CP-NC9W-K	6.E.2.7776	H264	√	Private
	CP-ND10-R	cp20111129AN S	H264	√	ONVIF
	CP-ND20-R	cp20111129AN S	H264	√	ONVIF
	CP-NS12W-C R	cp20110808NS	H264	√	ONVIF
	VS201	cp20111129NS	H264	√	ONVIF
	CP-NB20-R	cp20110808BN S	H264	√	ONVIF
	CP-NT20VL3- R	cp20110808BN S	H264	√	ONVIF
	CP-NS36W-A R	cp20110808NS	H264	√	ONVIF
	CP-ND20VL2- R	cp20110808BN S	H264	√	ONVIF
	CP-RNP-1820	cp20120821NS A	H264	√	Private
	CP-RNC-TP2 0FL3C	cp20120821NS A	H264	√	Private
	CP-RNP-12D	cp20120828AN S	H264	√	Private
	CP-RNC-DV1 0	cp20120821NS A	H264	√	Private
	CP-RNC-DP2 0FL2C	cp20120821NS A	H264	√	Private
Dynacolor	ICS-13	d20120214NS	H264	√	ONVIF/Private
	ICS-20W	vt20111123NSA	H264	√	ONVIF/Private
	NA222	—	H264	√	ONVIF
	MPC-IPVD-03 13	k20111208ANS	H264	√	ONVIF/Private
	MPC-IPVD-03 13AF	k20111208BNS	H264	√	ONVIF/Private
Honeywell	HIDC-1100PT	h.2.2.1824	H264	√	ONVIF
	HIDC-1100P	h.2.2.1824	H264	√	ONVIF

Manufacture	Model	Version	Video Encode	Audio/Video	Protocol
	HIDC-0100P	h.2.2.1824	H264	√	ONVIF
	HIDC-1300V	2.0.0.21	H264	√	ONVIF
	HICC-1300W	2.0.1.7	H264	√	ONVIF
	HICC-2300	2.0.0.21	H264	√	ONVIF
	HDZ20HDX	H20130114NS A	H264	√	ONVIF
LG	LW342-FP	—	H264	√	Private
	LNB5100	—	H264	√	ONVIF
Imatek	KNC-B5000	—	H264	√	Private
	KNC-B5162	—	H264	√	Private
	KNC-B2161	—	H264	√	Private
Panasonic	NP240/CH	—	MPEG4	√	Private
	WV-NP502	—	MPEG4	√	Private
	WV-SP102H	1.41	H264	√	ONVIF/Private
	WV-SP105H	—	H264	√	ONVIF/Private
	WV-SP302H	1.41	H264、MPEG4	√	ONVIF/Private
	WV-SP306H	1.4	H264、MPEG4	√	ONVIF/Private
	WV-SP508H	—	H264、MPEG4	√	ONVIF/Private
	WV-SP509H	—	H264、MPEG4	√	ONVIF/Private
	WV-SF332H	1.41	H264、MPEG4	√	ONVIF/Private
	WV-SW316H	1.41	H264、MPEG4	√	ONVIF/Private
	WV-SW355H	1.41	H264、MPEG4	√	ONVIF/Private
	WV-SW352H	—	H264、MPEG4	√	ONVIF/Private
	WV-SW152E	1.03	H264、MPEG4	√	ONVIF/Private
	WV-SW558H	—	H264、MPEG4	√	ONVIF/Private
	WV-SW559H	—	H264、MPEG4	√	ONVIF/Private
	WV-SP105H	1.03	H264、MPEG4	√	ONVIF/Private
	WV-SW155E	1.03	H264、MPEG4	√	ONVIF/Private
	WV-SF336H	1.44	H264、MPEG4	√	ONVIF/Private
	WV-SF332H	1.41	H264、MPEG4	√	ONVIF/Private
	WV-SF132E	1.03	H264、MPEG4	√	ONVIF/Private
	WV-SF135E	1.03	H264、MPEG4	√	ONVIF/Private
	WV-SF346H	1.41	H264、MPEG4	√	ONVIF/Private
	WV-SF342H	1.41	H264、MPEG4	√	ONVIF/Private
	WV-SC385H	1.08	H264、MPEG4	√	ONVIF/Private
	WV-SC386H	1.08	H264、MPEG4	√	ONVIF/Private
	WV-SP539	1.66	H264、MPEG4	√	ONVIF
	DG-SC385	1.66	H264、MPEG4	√	ONVIF
PELCO	IXSOLW	1.8.1-20110912 -1.9082-A1.661 7	H264	√	Private
	IDE20DN	1.7.41.9111-O3 .6725	H264	√	Private

Manufacture	Model	Version	Video Encode	Audio/Video	Protocol
	D5118	1.7.8.9310-A1.5288	H264	√	Private
	IM10C10	1.6.13.9261-O2.4657	H264	√	Private
	DD4N-X	01.02.0015	MPEG4	√	Private
	DD423-X	01.02.0006	MPEG4	√	Private
	D5220	1.8.3-FC2-20120614-1.9320-A1.8035	H264	√	Private
Samsung	SNB-3000P	2.41	H264、MPEG4	√	ONVIF/Private
	SNP-3120	1.22_110120_1	H264、MPEG4	√	ONVIF/Private
	SNP-3370	1.21_110318	MPEG4	√	Private
	SNB-5000	2.10_111227	H264、MPEG4	√	ONVIF/Private
	SND-5080	—	H264、MPEG4	√	Private
	SNZ-5200	1.02_110512	H264、MPEG4	√	ONVIF/Private
	SNP-5200	1.04_110825	H264、MPEG4	√	ONVIF/Private
	SNB-7000	1.10_110819	H264	√	ONVIF/Private
	SNB-6004	V1.0.0	H264	√	ONVIF
Sony	SNC-DH110	1.50.00	H264	√	ONVIF/Private
	SNC-CH120	1.50.00	H264	√	ONVIF/Private
	SNC-CH135	1.73.01	H264	√	ONVIF/Private
	SNC-CH140	1.50.00	H264	√	ONVIF/Private
	SNC-CH210	1.73.00	H264	√	ONVIF/Private
	SNC-DH210	1.73.00	H264	√	ONVIF/Private
	SNC-DH240	1.50.00	H264	√	ONVIF/Private
	SNC-DH240-T	1.73.01	H264	√	ONVIF/Private
	SNC-CH260	1.74.01	H264	√	ONVIF/Private
	SNC-CH280	1.73.01	H264	√	ONVIF/Private
	SNC-RH-124	1.73.00	H264	√	ONVIF/Private
	SNC-RS46P	1.73.00	H264	√	ONVIF/Private
	SNC-ER550	1.74.01	H264	√	ONVIF/Private
	SNC-ER580	1.74.01	H264	√	ONVIF/Private
	SNC-ER580	1.78.00	H264	√	ONVIF
	SNC-VM631	1.4.0	H264	√	ONVIF
	WV-SP306	1.61.00	H264、MPEG4	√	SDK
	WV-SP306	1.61.00	H264	√	ONVIF
	SNC-VB600	1.5.0	H264	√	Private
	SNC-VM600	1.5.0	H264	√	Private
SNC-VB630	1.5.0	H264	√	Private	
SNC-VM630	1.5.0	H264	√	Private	
SANYO	VCC-HDN4000PC	—	H264	√	ONVIF

Note

- **This manual is for reference only. Slight difference may be found in the user interface.**
- **All the designs and software here are subject to change without prior written notice.**
- **All trademarks and registered trademarks are the properties of their respective owners.**
- **If there is any uncertainty or controversy, please refer to the final explanation of us.**
- **Please visit our website or contact your local service engineer for more information.**

ZHEJIANG DAHUA VISION TECHNOLOGY CO.,LTD.

Address:No.1199, Bin'an Road, Binjiang District, Hangzhou, P.R. China

Postcode: 310053

Tel: +86-571-87688883

Fax: +86-571-87688815

Email:overseas@dahuatech.com

Website: www.dahuasecurity.com